



ENTERTAINMENT MEMORABILIA
LIVE AUCTION



TREASURES FROM FILM AND TELEVISION

IN PARTNERSHIP WITH



20TH SEPT. 2018 | LONDON



About Prop Store

Prop Store was founded on the belief that the props and costumes used in movies are pieces of art—film art. We see these artefacts not as mere byproducts of the production process, but as unique, creative works in their own right. The result of the collective effort of designers, fabricators, and artisans from every corner of the globe, many of these pieces are simply extraordinary.

Private collectors have played a significant role in preserving these film art pieces since the earliest days of cinema and television. Throughout the entertainment industry's history, these items were considered as mere production tools and were therefore commonly discarded time and time again. Private collectors have stepped in on many occasions and taken preservation into their own hands. Some film and television artefact collecting stories are legendary: A college student walking through a field and stumbling upon the model miniature space station from 2001: A Space Odyssey after the item was dumped from an unpaid storage locker, for example. Many of cinema's most memorable treasures are cared for by private collectors, and we believe that private collectors continue to play a critical role in the overall preservation and legacy of film and television history. Collecting is a very personal thing as all collectors have different tastes—but collectors are united through a common passion for the material and its preservation.

Each of Prop Store's team members share this belief and are long-time, passionate collectors themselves. We love this material. We revere this material. Our enthusiasm is the driving force in our nearly two decade global search to locate these culturally-significant items. Our journey has enabled us to forge key



relationships within the industry that have provided access to material previously believed to be unavailable. We are also in continuous contact with those on the front lines of production. These individuals educate us and assist us in properly identifying and authenticating material. In turn, we have educated and supported the collecting community by sharing our knowledge through articles, videos and collecting websites and forums.

We are excited to share this catalogue with collectors around the world. Within this sale you will find pieces available at every price point—all of which are authenticated and certified with our industry-leading certificate of authenticity and its accompanying guarantee. Each of these pieces satisfy our strict internal authentication standards.

We strive to present these pieces with the same level of care that went into their presentation on screen, as they deserve nothing less. A large portion of the artefact collection will be on public exhibition prior to the sale, providing a first-hand view of the material. Whether you are a veteran collector or just getting started, we hope that you find pieces that speak to you amongst this truly unique offering. To make this material more accessible, every item can be purchased on an interest-free payment plan. We can also pack and ship material safely to any destination in the world.

Our experience, passion and desire to source the most exciting pieces possible makes us one of the world's leading vendors of original props, costumes and collectable memorabilia. We look forward to being a part of your own collecting journey and to helping you preserve these beloved pieces of film and television history.



FRONT COVER IMAGE

Lot #463 Han Solo's (Harrison Ford) Jacket
STAR WARS: THE EMPIRE STRIKES BACK (1980)

Follow the auction on Prop Store's social media platforms [#PropStoreLiveAuction](#)



ENTERTAINMENT MEMORABILIA LIVE AUCTION

THURSDAY, 20TH SEPTEMBER 2018 AT 12 PM

PropStore.com/liveauction



Auction Contact

Find the latest information, browse the auction catalogue and place bids at propstore.com/liveauction
For all inquiries related to registering, bidding, payment or shipping, please contact our auction support staff:

- ◆ General Auction Inquiries ☎ +44 (0) 1494 766485
- ◆ Fax ☎ +44 (0) 1494 766487
- ◆ Viki Merry, Project Manager ✉ viki@propstore.com
- ◆ Tim Lawes, General Manager ✉ tim@propstore.com
- ◆ Felicity Beardshaw, Press Inquiries ✉ felicity@propstore.com

For your convenience, our Los Angeles office is also available to field inquiries relating to the London auction from 9:00am - 5:30pm PST at +1 (818) 727 7829

Terms & Info

Buying with Prop Store

For an overview of how to participate in this auction as a buyer, please refer to the Buyer's Guide on page 410 of this catalogue.

Conditions of Sale

This auction is governed by important stipulated terms, conditions and reserves. All stipulations can be found on page 412 of this catalogue. Please note, some of the items in this sale attract VAT. Please see our VAT quick reference guide at the bottom of page 415. For a more thorough explanation see clause 5.2.4 of the buyer's guide

Bidding Increments

The following are suggested bid increments for the Auction. Please be advised that they are suggested increments only, are not intended to be and shall not be binding, and the Auctioneer retains the sole and absolute discretion, at the time of the Auction, to change, modify, or vary the bid increments at any time.

- £10 - £50 by £10
- £50 - £500 by £25
- £500 - £2,000 by £100
- £2,000 - £5,000 by £250
- £5,000 - £10,000 by £500
- £10,000 - £20,000 by £1,000
- £20,000 - £50,000 by £2,500
- £50,000 - £100,000 by £5,000
- £100,000+ at the Auctioneer's discretion

Entertainment Memorabilia Live Auction

Thursday, 20 September at 12 pm
Hosted at the **ODEON BFI IMAX**
1 Charlie Chaplin Walk
Waterloo
London SE1 8XR

Bidders are advised to arrive early to register for the auction. Bidding is also available online, via telephone and via absentee form. Whether registering online or in person, at least one (1) form of ID is required which must include one (1) government-issued photo identification. If this does not state your current address, proof of address will also be required. Please see the bidding registration document at the back of the catalogue for additional information.

Exhibition

Thursday 6 September - Thursday 20 September

10:00 am - 9:30 pm Monday through Friday
11:00 am - 9:30 pm Saturday & Sunday

A museum-grade exhibition showcasing over 270 of the auction lots will be presented to the public for the two weeks prior to the sale. The exhibition offers an opportunity to examine many lots in person. Please enquire if the lot you are interested in is included in the exhibition. Lots not present at the exhibition can be viewed by appointment at Prop Store's office in Rickmansworth.

Hosted at the **ODEON BFI IMAX** | 1 Charlie Chaplin Walk, Waterloo, London SE1 8XR

Pre-Auction Drinks Reception

Please come and mingle with collectors, friends and Prop Store specialists before the action starts!

Online

Bid live from anywhere in the world via Prop Store's live online Auction Platform. Register today at: propstore.com/liveauction

Browse and place bids on your computer or mobile device via our interactive online catalogue. The online catalogue features exclusive video content and additional photo galleries beyond that available in the printed catalogue. Download the online catalogue at: propstore.com/liveauction

The Prop Store Certificate of Authenticity

Authenticity is the defining collectable element for original film and television props and costumes. All of our certificates carry multiple security elements to verify authenticity, representing a lifetime guarantee that the item is a genuine piece of cinema history exactly as described.



TIE Fighter Pilot Helmet STAR WARS: A NEW HOPE (1977) | Sold: £216,000



Entertainment Memorabilia Live Auction 2019
Consignments now being accepted

FOR CONSIGN
2019

Email: Tim Lawes, tim@propstore.com

1. Immortal Warrior Costume M

300 (2006)

An Immortal Warrior costume from Zack Snyder's sword-and-sandals action film *300*. Xerxes' (Rodrigo Santoro) elite Persian warriors wore their costumes during the epic battle scenes in which they fought the Spartans.

Multiple layers create the warriors' signature attire. The upper part of the costume consists of a black cotton hood and a silver-coloured, chromed fibreglass mask. Mesh has been applied to the inside to disguise the wearer's face. The under layer of the costume consists of a neck piece, a suede-like sleeved top, a leather padded chest piece, a pair of trousers, a sash around the waist and prosthetic foam-latex hands and feet. "AW, 3" is written on the inside of the mask, the text "Benoit Dufour" features on the sash and the jumper is labelled "Jon Eusebio, 40/s".

Layered armour pieces cover the shoulders, arms, chest and outer legs, all made from a combination of plastic and rubber with a black leather trim and decorative brown suede-like cord. Leather straps have been attached, allowing the armour to be fixed to the under layer of the costume. Multiple components of the armour are labelled "Jon Eusebio", a stuntman who worked on the production.

A pair of twin-crossed black plastic scabbards with rubber swords are mounted on the warrior's back. Signs of wear from production use are present, including tears and paint wear on the foam latex. Minor scratches and paint wear are also apparent on the chest armour and mask. The costume is presented on a custom-made mannequin display.

Dimensions (on display): 46 cm x 78 cm x 193 cm (18 ¼" x 30 ¾" x 76")

£8,000-10,000



2. Ahmed Ibn Fahdhan's (Antonio Banderas) Wendol Cave Costume Ω

THE 13TH WARRIOR (1999)

Ahmed ibn Fahdhan's (Antonio Banderas) costume from John McTiernan's historical action film *The 13th Warrior*. In the film, exiled Arab ambassador Ahmed ibn Fahdhan joins a band of Norse warriors on an epic quest. Ibn wore his dark outfit under chain mail when he ventured into the Wendol cave.

This costume includes a hand-stitched cotton jacket with suede sleeves and a hidden zipper at the back that is concealed beneath a flap. Worn under the jacket is an off-white knee-length shirt that closes in front with 27 loop-and-button closures. The shirt is dressed in faux blood from the battle. Ibn Fahdhan's black trousers are made of linen and cotton, with zippers at the front and back. Also includes are his metal-plated leather gloves and tall black leather boots.

The costume is marked "Ibn No. 3" inside the jacket, "Ibn 2" in the shirt, "Antonio #2" in both gloves, and has "Ibn" crossed out in marker in the boots. The costume shows intentional production distressing, with faux blood on the shirt and mud caked on the boots.

£2,000-3,000

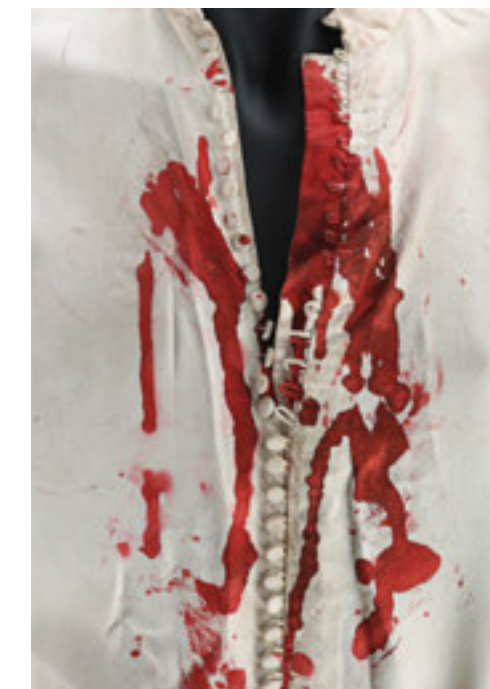
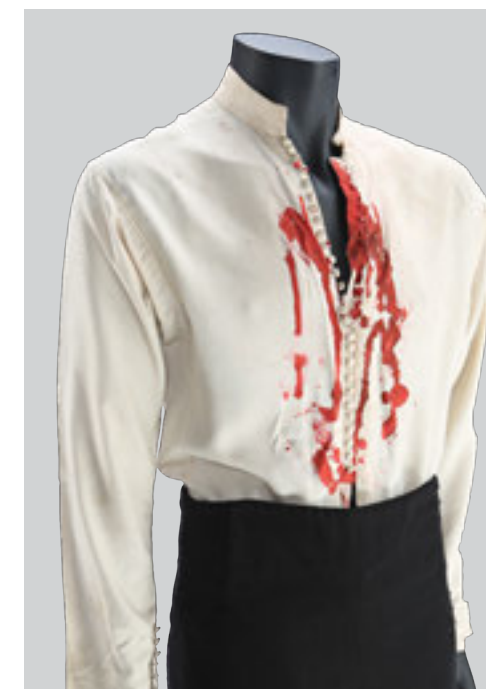

3. Main Cast-Autographed "The Thing That Wouldn't Die Part II" Script Ω

3RD ROCK FROM THE SUN (TV SERIES 1996 - 2001)

An autographed script from the final episode of the TV comedy *3rd Rock from the Sun*. Used for the season 6 finale "The Thing That Wouldn't Die, Part II", this final draft is dated "1/22/01" and was written by Dave Goetsch, Jason Venokur and Christine Zander.

Hand-signed for "Tim", it features personal messages from Kristen Johnson and Joseph Gordon-Levitt, with autographs including Wayne Knight, French Stewart, Jane Curtin, Ron West and Ileen Getz. Included is a call sheet for "Tuesday 23 January 2001", with listed cast members including John Lithgow and Elvis Costello, and four show order sheets. The documents show minor marking and creasing from use.

Dimensions: 29 cm x 22 cm x 1 cm (11 ½" x 8 ¾" x ½")

£300-500

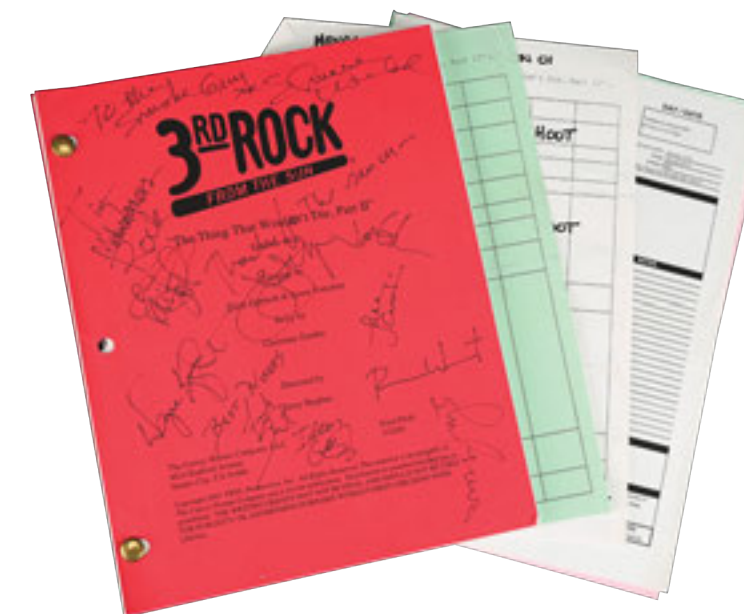

4. Pair of Animatronic Teddy Heads Ω

A.I. ARTIFICIAL INTELLIGENCE (2001)

A pair of animatronic Teddy heads from Steven Spielberg's sci-fi film *A.I. Artificial Intelligence*. In the late 22nd century, a Mecha child named David (Haley Joel Osment) embarked on a quest to become "real" so he could win the affection of his human mother. Teddy was a robotic teddy bear who accompanied David on his journey. This lot consists of two animatronic heads, one of which is fully covered in faux fur, while the second only has fur over the ears, with the interior mechanics fully exposed.

Created by Stan Winston Studio, Teddy was the most sophisticated animatronic Winston ever designed, containing 50 points of motion — far more than even the dinosaurs in Jurassic Park. Controlled by numerous puppeteers using cable controls and electronic servos, Teddy was designed to interact with the actors on set, in real time.

The fur-covered Teddy is mounted to a metal base, and shows "Frightened" written on a label stitched inside the fur, as well as on a strip of tape applied to the base. The fur features an open seam on the left side of the head, with access to the interior electronics. The Teddy heads show minor wear due to production use and age, with the foam on the fur-covered head brittle in a number of places. The lot remains in fine overall condition. Dimensions: (on base): 23 cm x 23 cm x 21.5 cm (9" x 9" x 8 1/2"); (head only): 19 cm x 16 cm x 16.5 cm (7 1/2" x 6 1/4" x 6 1/2")

This item contains electronic components. While every effort has been made to describe them accurately, no guarantee or warranty is made as to the functionality, lifespan or safety of those components. It is entirely incumbent on the new owner to satisfy themselves as to their safe use and maintenance.

£8,000-10,000



5. Storyboard Binder and Production Ephemera Ω

THE ABYSS (1989)

A storyboard binder and production ephemera from James Cameron's underwater sci-fi adventure *The Abyss*. This set includes a storyboard binder, photo binder and an animatics VHS tape.

The storyboard binder contains over 50 pages pertaining to the underwater special effects. More than 150 photos are present, including behind-the-scenes shots of the film's models. Additionally, this set includes four production copies of designs for the submersibles used in the film.

Each of the four crew patches are embroidered and relate to the underwater unit for the film. The untested VHS tape is labeled on the side with "Abyss — Video Animatics Hero Takes from Tapes 1-5". This set shows some signs of wear to the paperwork, but is in fine overall condition. Dimensions (binder): 29 cm x 29 cm x 5 cm (11 1/2" x 11 1/2" x 2"); (each submersible design): 43 cm x 28 cm (17" x 11"); (largest patch): 11.5 cm x 5 cm (4 1/2" x 2")

£600-800



6. Bud Brigman (Ed Harris) Dive Suit Model Miniature Puppet Head Ω

THE ABYSS (1989)

A Bud Brigman (Ed Harris) dive suit model miniature puppet head from James Cameron's underwater sci-fi adventure *The Abyss*. Known for its technical achievements, this film won an Academy Award® for its ambitious effects work. This miniature head was used inside a miniature dive suit helmet for scenes showing the character descending into the unknown.

This head is produced from rotocasted resin and is painted in enough detail to appear realistic if seen from a distance. The piece is painted with light-coloured skin tones and is unpainted on parts that would not be visible inside its suit. Portions of glue residue are present around the scalp and small pieces of faux hair remain attached. This piece shows some signs of wear from storage and use, including some blemishes to the paint, but it remains in fine overall condition.

Dimensions: 11.5 cm x 11.5 cm x 19 cm (4 1/2" x 4 1/2" x 7 1/2")

£600-800

7. Ron Cobb Hand-Drawn Deep Core Elevation Ω

THE ABYSS (1989)

A hand-drawn elevation showing the Deep Core from James Cameron's underwater sci-fi adventure *The Abyss*. Drafted by conceptual designer Ron Cobb, the elevation shows the Deep Core, a massive underwater drilling platform.

the bottom of the plate is "ABYSS" and "DEEP CORE 2". The artwork is taped at the sides to a sheet of cardboard, and shows minor wear to the paper due to use and age, with small tears around the perimeter. However, it remains in good overall condition. Dimensions: 91 cm x 61 cm x 1 cm (35 3/4" x 24" x 1/4")

Drawn in 1/8"=1'-0" scale, the elevation is rendered in pencil on large grid paper, and shows handwritten labels identifying the various locations on the station. Written at

£1,000-1,500

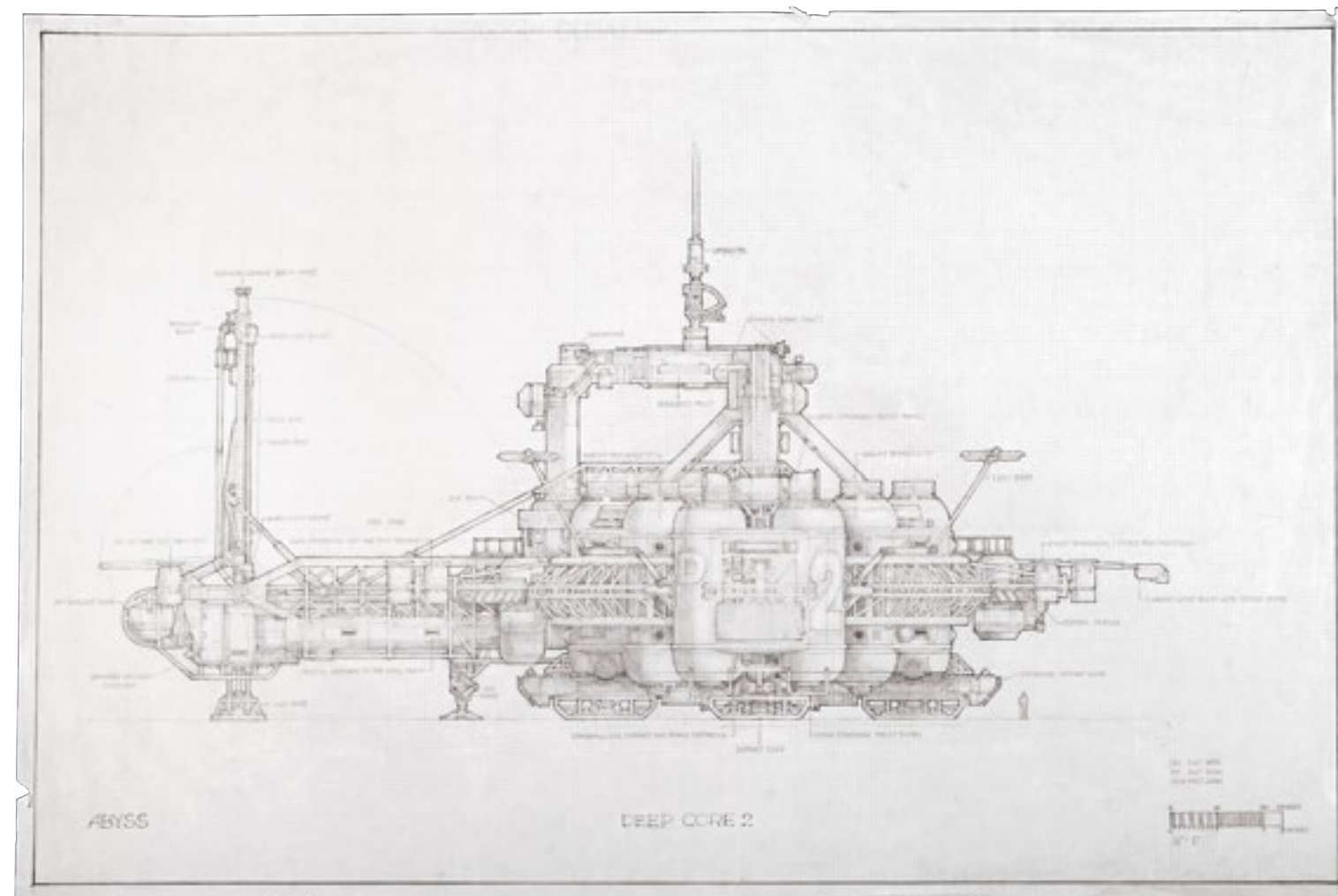

8. Cab 3 Submarine Model Miniature, Printed Drafting, Decals and Component Castings US

THE ABYSS (1989)

The Cab 3 submarine model miniature, drafting plans, decals and various miniature components from James Cameron's underwater sci-fi adventure *The Abyss*. Known for its technical achievements, this film won an Academy Award® for its ambitious effects work. The Cab submersible vehicles were used in a number of scenes throughout the film, and were primarily used to transport visitors down to the Deep Core mining facility deep below the ocean's surface.

The film used both a full-size Cab sub, and two model-miniature versions. Created by Design Setters, the two model-miniature Cab vehicles were repainted throughout the production to represent a larger number of vehicles. The model was rigged in the air and shot dry-for-wet on a soundstage at Dreamquest. It was made to appear as if underwater through the use of smoke and camera filters. The hull and conning tower are made of Dynacast, resin and fiberglass, with the crash rails made of hand-soldered brass tubing. The viewing dome is constructed from two non-concentric acrylic domes that are glued together to a ring of Plexiglas, with the space in between filled with mineral oil. The end result mimicked the lensing effect created when the real domes were underwater.

The submarine miniature includes numerous miniature floodlights and a poseable robotic arm at the front of the vehicle. The sub is expertly painted by hand, using acrylic lacquer, and shows "3" as the vehicle number, identifying it as a key transport seen in the film. A compact video projector was rigged in other cab models, to project footage of the actors inside the cockpit, but this cab was never outfitted with a projector.

Accompanying the model miniature are various model components and paperwork. Three production-copied drafting elevations of the Cab model miniature are included, which are printed on paper and dated "June 5, 1988". Two sheets of dry transfer decals are also provided, with decals for "CAB" and "13". Unpainted model-miniature components include a Cab access hatch, vent hatches, a propeller, a fin and miniature floodlight components.

The model exhibits minor wear due to production use and age, and has been sympathetically restored and repainted in small areas by the original model maker. The lot remains in very fine condition.

Dimensions (model miniature):
71 cm x 38 cm x 30.5 cm (28" x 15" x 12);
(drafting prints): 61 cm x 42 cm (24" x 16 1/2");
(combined miniature casting components):
20 cm x 23 cm x 6 cm (8" x 9" x 2 1/2")

This item contains electrical components. While every effort is made to describe them accurately, no guarantee or warranty is made as to the functionality, lifespan or safety of those components. It is entirely incumbent on the new owner to satisfy themselves as to their safe use and maintenance.

£30,000-50,000

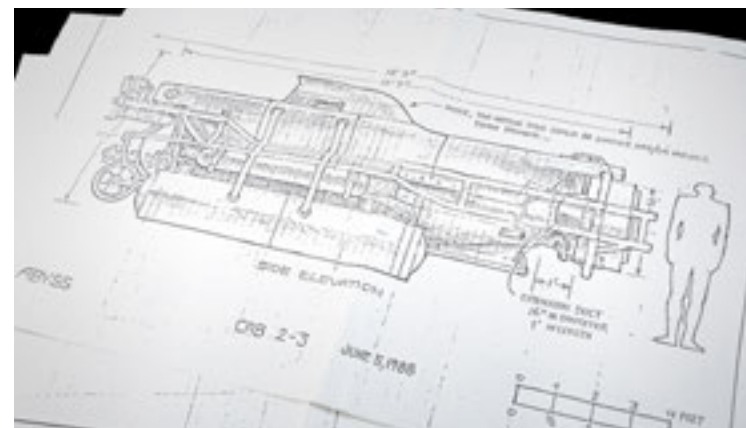



9. Wednesday Addams' (Christina Ricci) Costume M



10. Uncle Fester's (Christopher Lloyd) and Lurch's (Carel Struycken) Signature Costumes Ω



11. Wednesday Addams' (Christina Ricci) and Pugsley Addams' (Jimmy Workman) Signature Costumes Ω



12. Morticia Addams' (Anjelica Huston) and Gomez Addams' (Raul Julia) Signature Costumes Ω



THE ADDAMS FAMILY (1991)

Wednesday Addams' (Christina Ricci) costume from Barry Sonnenfeld's dark comedy *The Addams Family*. Wednesday wore her dress at the celebratory party for Uncle Fester's (Christopher Lloyd) return, and when she hid in the cemetery after she overheard Abigail (Elizabeth Wilson) and Gordon's (Christopher Lloyd) scheme.

The costume is made of black cotton with an embossed baroque-inspired pattern featuring all over. Two pleated chiffon godets adorn the bottom of the dress and matching pieces of chiffon hang from the sleeves. Sections of sheer spiderweb fabric are incorporated into the sleeves and the back features a zip fastening. The costume shows wear, including minor marks and fraying to the edges of the chiffon.

Dimensions (on display): 30 cm x 41 cm x 126 cm x (12" x 16 1/4" x 49 3/4")

£800-1,200

THE ADDAMS FAMILY (1991)

Uncle Fester (Christopher Lloyd) and Lurch (Carel Struycken) signature costumes from Barry Sonnenfeld's dark comedy *The Addams Family*. Uncle Fester wore his trademark longcoat once he returned home to the Addams residence, while Lurch wore his manservant uniform throughout the film.

Designed by Ruth Myers, Fester Addams' bespoke longcoat is made of soft drapery fabric, and features a muted floral pattern throughout. The coat was worn closed and buttons up in front, and includes two deep front pockets.

Lurch's suit comprises a heathered coat, a tuxedo shirt, a silk tie and a pair of woollen trousers. The jacket is made by High Society and includes a wardrobe label inside the lapel pocket that reads "Carel Struycken". Stitched to the inseam of the trousers is another wardrobe label which reads "Lurch" and "10/15/90". From The Comisar Collection, the costumes exhibit minor wear due to production use and age, but remain in very fine condition.

£2,000-3,000

THE ADDAMS FAMILY (1991)

Wednesday Addams (Christina Ricci) and Pugsley Addams' (Jimmy Workman) signature costumes from Barry Sonnenfeld's dark comedy *The Addams Family*. Wednesday and Pugsley Addams wore their costumes throughout the film. Wednesday's costume consists of a dress, while Pugsley's comprises a coat, a shirt, a pair of shorts and a set of socks and boots.

Wednesday's long-sleeved dress is made from a cotton blend, and is black with a grey line and scribbled-dot pattern printed on it. The dress is a button-down style and includes a textured white collar.

Pugsley's black coat is made of wool, and his black-and-white striped shirt is made of cotton. The black shorts come with a set of elastic suspenders sewn into them. Also included are Pugsley's black cotton socks and leather boots, along with a wardrobe tag noting the character, actor and change number.

From The Comisar Collection, both costumes show minor signs of wear due to age, but remain in very good overall condition.

£3,000-4,000

THE ADDAMS FAMILY (1991) / ADDAMS FAMILY VALUES (1993)

Gomez Addams' (Raul Julia) signature suit from Barry Sonnenfeld's dark comedy *The Addams Family Values*, and Morticia Addams' (Anjelica Huston) classic gown from *The Addams Family* and *The Addams Family Values*.

Morticia wore her trademark gothic brocade gown in numerous scenes throughout the first and second films. Designed by Ruth Myers, the gown features an elegant V-neck with decorative beading around its perimeter. The sleeves and train include intentionally distressed strips of material that drape freely.

Gomez's bespoke black-and-grey double-breasted pinstripe suit includes a dress jacket with matching trousers, a dress shirt, a bowtie, a pair of wingtip dress shoes, a pair of elegant house slippers, two pairs of socks and two handkerchiefs. Both the jacket and the trousers feature a Barbara Matera label stitched inside that reads "Mr. Julia". Written at the neck of the white dress shirt is "RJ".

From The Comisar Collection, the costumes exhibit minor wear due to production use and age, with some beads having fallen off the neck of Morticia's dress, but remain in very fine condition.

£5,000-7,000

13. Space Jockey Plaster Maquette †Δ

ALIEN (1979)

A Space Jockey maquette from Ridley Scott's Academy Award®-winning sci-fi classic, *Alien*. Dallas (Tom Skerritt), Kane (John Hurt) and Lambert (Veronica Cartwright) discovered a large fossilised alien creature while exploring an abandoned spacecraft on LV-426.

Referred to as the "Space Jockey" during the production, the Alien Engineer's appearance was designed by H.R. Giger. The maquette would have been created as a concept model and shows the creature bonded to its pilot seat. Made of plaster, the piece displays intricate cast-in detailing fitting in with the production's biomechanical aesthetic. The maquette shows minor wear and marks from use on production.

Dimensions: 33 cm x 14 cm x 28 cm (13" x 5 ½" x 11")

£600-800



14. Nostromo Shuttle Emergency Spacesuit †Δ

ALIEN (1979)

A Nostromo shuttle emergency spacesuit from Ridley Scott's Academy Award®-winning sci-fi classic *Alien*. Spacesuits were hung on the wall of the Narcissus shuttle used by Ellen Ripley (Sigourney Weaver) to escape the Alien-invaded Nostromo. After finding the creature on board the shuttle, Ripley opened the shuttle's airlock, propelling it into space.

The spacesuit is a 1960's high-altitude pressure suit made from thin white fabric, with modifications and additional components added to create a futuristic appearance. Multiple tubes are sewn into the garment, and a white plastic control panel with a faux-silver dial and foam exterior is attached to the front. The suit is completed with a helmet — made of plastic, with various metal components and a clear acrylic visor — and two brown rubber gloves finished with yellow foam padding. The text "BWT/R/12/65" appears on the helmet, and "5" is written in black on the interior of the suit and on both wrists. The costume displays signs of production use and aging, including minor paint wear, a broken visor, discolouration and marks throughout. The costume comes on a custom-made display and is accompanied by two promotional stills.

Dimensions (displayed): 31 cm x 59 cm x 200 cm (12 ¼" x 23 ¼" x 78 ¾")

£4,000-6,000

15. Production-Used Script †Δ

ALIENS (1986)

A production-used script from James Cameron's sci-fi action sequel *Aliens* (1986). This final draft was used during the production of the Oscar®-winning classic. It is credited to director Cameron and labelled "Final Draft September 1985".

Printed in black typeface on white U.S. Letter paper, the 106-page script is bound in a blue card folder with metal split pins. A rectangular cover cut-out showcases the title "Aliens", with the number "96" handwritten in silver at the top-right corner. The number is repeated on the title page, which carries contact details for 20th Century Fox at the time of production. The rear page bears the Words Scripts Services emblem and contact details. Each page is unannotated, with minor yellowing from natural ageing. The cover is creased from use during production, with minor stains on the front, rear and leaf edges. Dimensions: 28.5 cm x 22 cm x 1.5 cm (11 ¼" x 8 ¾" x ½")

£500-700

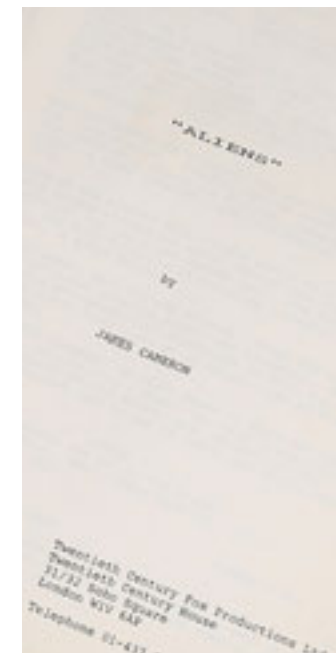

16. Terry Lamb Hand-Drawn Poster Concept Art M

ALIENS (1986)

Hand-drawn original poster concept art for James Cameron's sci-fi action sequel *Aliens*. The pencil sketch was drawn by poster campaign artist Terry Lamb on tracing paper. Roughly A3-size, it depicts — from left to right — the recognisable faces of Hicks (Michael Biehn), Bishop (Lance Henriksen), Ripley (Sigourney Weaver), Frost (Ricco Ross), Hudson (Bill Paxton) and Vasquez (Jenette Goldstein).

An early visualisation of the official promotional poster, it echoes that poster's design with a rifle-toting Ripley dominating the centre. Hicks, Frost and Hudson wear helmets with microphones, while Hicks holds a Pulse Rifle and Frost carries his flamethrower. The drawing is yellowed from natural ageing, with creases down the centre and top left. Smaller creases and minor edge tears can be seen across the paper. Dimensions: 48 cm x 31.5 cm x 0.1 cm (19" x 12 ½" x ¼")

£800-1,200



17. Miniature Translucent Alien Queen Egg Ω

ALIENS (1986)

A miniature translucent Alien Queen egg from James Cameron's sci-fi action sequel *Aliens*. Ripley (Sigourney Weaver) laid waste to the Alien Queen's nest during the film's climactic encounter. A variety of eggs were created for the ¼ scale model of the nest, with this translucent egg made for the interior of the egg sac, which was lit from behind.

Made of vacuform plastic, the egg comprises two pieces that are glued together along the centre. The egg is lightly painted and remains in very fine condition.

Dimensions: 7 cm x 9 cm x 6 cm (2 ¾" x 3 ½" x 2 ¼")

£300-500



18. Private Hudson's (Bill Paxton) Dog Tags M

ALIENS (1986)

Private Hudson's (Bill Paxton) dog tags and a set of publicity stills from James Cameron's sci-fi action sequel *Aliens*. Hudson wore his dog tags throughout the film, most visibly during his awakening from hypersleep on the USS Sulaco.

Made from clear acrylic, both tags hang from a metal ball-chain necklace and are printed with "Pt. W. HUDSON" and "A08/TQ1.041776E3". The four black-and-white photographs are individually numbered and feature the title "Twentieth Century Fox Presents ALIENS", with cast and character names and scene descriptions. They depict the Marine briefing scene, and Ripley (Sigourney Weaver) strategising with Hudson and Hicks (Michael Biehn) on the planet LV-426.

A portrait of a flamethrower-toting Ripley in the Xenomorph hive and a full cast shot complete the set. Distressed for production, Hudson's dog tags feature some wear and scratching. The glossy photographs remain unbent and unmarked.

Dimensions (dog tags): 4.7 cm x 2.8 cm x 0.01 cm (2" x 1 ¼" x ¼"); (dog tags on chain): 37.5 cm x 2.8 cm x 0.01 cm (14 ¾" x 1 ¼" x ¼"); (photographs): 25.5 cm x 20 cm x 0.02 cm (10" x 7 ¾" x ¼")

£2,000-3,000



19. Xenomorph Egg †Δ

ALIENS (1986)

A Xenomorph egg from James Cameron's sci-fi action sequel *Aliens*. Eggs were used in the Xenomorph hive, where the Alien Queen spawned her terrifying offspring. Rows of Xenomorph eggs were seen when Ripley (Sigourney Weaver) entered the alien hive to rescue Newt (Carrie Henn) and torched the chamber with her flamethrower. Static and animatronic models were made for production — this is an example of one of the full size closed, static eggs used in the hive scenes.

Made from fibreglass, the hollow egg has been painted with mottled green colours for a leathery, organic appearance, with hot glue veining to resemble oozing mucus. The top features the iconic 'X' shape from which the alien Facehuggers emerge, closed with a silicone-like material along each of the four folds.

Intentionally distressed for production, the egg has patches of burnt fibreglass along the surface from Ripley's flamethrower assault. The Xenomorph egg has acquired some damage since shooting, including chips, scrapes and holes in the fibreglass.

Dimensions: 50 cm x 45 cm x 92 cm (17 ¾" x 19 ¾" x 36 ¼")

£3,000-5,000

20. Dietrich's (Cynthia Dale Scott) Abdominal Armour M

ALIENS (1986)

Dietrich's (Cynthia Dale Scott) abdominal armour from James Cameron's sci-fi action sequel *Aliens*. Colonial Marine Dietrich wore her body armour during the drop to planet LV-426, throughout the colony and hive exploration scenes, and in the medical lab where young colonist survivor Newt (Carrie Henn) was first being assessed. This piece was worn beneath her chest and shoulder armour, protecting her lower body.

Devised by costume designer John Mollo, the Marines' armour blended a bold, modern military style with a Vietnam War aesthetic. Each character had their own graffiti-customised body armour, with Dietrich adopting a more subdued, traditional style.

Made by armourer Terry English, Dietrich's armour comprises grey leather fitted with beaten metal plates. The main piece features large ribbed pads, while the metal pieces are painted with a camouflage design. Ratchet clips at each side allow for fastening to the rest of the suit, with a short strap at the base. On the back, the names "Dietrich" and "Scott" have been handwritten in marker pen. Distressed for production, the metal plates feature noticeable scratching and paint wear, while the leather is scuffed and well-worn.

Dimensions: 43 cm x 38 cm x 3 cm (17" x 15" x 1 ½")

£2,000-3,000





21. Colonial Marine Flamethrower †Δ

ALIENS (1986)

A Colonial Marine Flamethrower from James Cameron's 1986 sci-fi action sequel *Aliens*. Frost (Ricco Ross), Apone (Al Matthews), Dietrich (Cynthia Dale Scott) and Drake (Mark Rolston) carried M240 Incinerator Units during the base and hive exploration scenes. Ripley (Sigourney Weaver) also used a Pulse Rifle/flamethrower combination she constructed aboard Dropship 2, after being rescued by Bishop (Lance Henriksen) en route to the hive when rescuing Newt (Carrie Henn). Interestingly, Ross stated his character was ironically named Frost by Cameron, given his accidental death by Dietrich's flamethrower.

Made from fibreglass, this static 'carry around' flamethrower was used when live-fire models and hero flamethrowers weren't needed for close-up shots.

SFX supervisor John Richardson and conceptual designer Ron Cobb created several different versions of each weapon for production. This item is loosely based on existing military hardware, consisting of two M16 rifles spliced together, while the front section is based on an M203 grenade launcher with its handle and receiver sections evident at the centre. A Colt Patent Firearms logo is embossed near the butt end.

The flamethrower is painted green, with characteristic features including muzzle exhaust holes, safety switches and essential chassis details. It features marks, stains and chipped paintwork from production use, most notably around the fuel canister and protruding parts. Red sand can be seen in its crevices, indicating use outdoors.

Dimensions: 82 cm x 13 cm x 52 cm (32 ½" x 5" x 20 ½")

£20,000-30,000

22. SFX Xenomorph Creature Head †Δ

ALIENS (1986)

A special effects Xenomorph creature head from James Cameron's sci-fi action sequel *Aliens*. Created for non-animatronic shots, the head was used in one of the many battle scenes in the Hadley's Hope Colony, as the Colonial Marines go to war with the Aliens. Special effects heads were worn by stunt performers, as part of the background or used on mannequin-style puppets when Cameron needed specific poses an actor could not achieve.

The creature design for *Aliens* was a simplified version of the one seen in the original 1979 film, allowing for maximum mobility, given the hordes of aliens moving down walls, over ceilings and through tunnels. Durability and practicality were key design concerns, and the dome from the original Alien was removed, resulting in the ribbed design seen on this piece.

Made from black urethane foam, the head has been hand-painted with contrasting dark hues to create an organic, insectoid look. Its even texture and shine are a result of sponge painting, while intricate facial and anatomical details enhance its realism.

Behind the jaw is a large opening for mounting — there are cracks around the edges from production use and natural ageing. The head's exterior shows small surface cracks, with minor damage to the left side of the face and loose inner teeth from use on set. It includes a custom-made wood-and-metal display stand.

Dimensions (head): 92 cm x 15 cm x 30 cm (36 ¼" x 6" x 11 ¾"); (stand): 26.7 cm x 4.3 cm x 44.7 cm (10 ½" x 1 ¾" x 17 ½"); (head on stand): 92 cm x 15 cm x 54 cm (36 ¼" x 6" x 11 ¾")

£20,000-30,000



23. Frost's (Ricco Ross) Colonial Marine Armour Chest Plate M

ALIENS (1986)

Frost's (Ricco Ross) Colonial Marine armour chest plate from James Cameron's sci-fi action sequel *Aliens*. PFC Frost and his fellow Colonial Marines wore their camouflaged armour on LV-426 during their search-and-rescue operation. The plate screen-matches to several scenes, including the discovery of the facehuggers in the laboratory, and Frost's final scenes inside the Xenomorph nest. The Colonial Marine costumes were designed by director James Cameron and Emma Porteus, with the armour created by legendary British armourer Terry English.

Handcrafted from aluminium, the armour features a unique hand-painted camouflage design in shades of green, brown and grey. The marine's name is stencilled in black paint below the neck, above a crudely etched arrow-pierced heart and the name "Heath". A number of green straps and plastic buckles are still present, one of which has separated from the rest of the amour. "Ross" is etched inside the plate. A green patch labelled "Frost" originally from the characters camouflage BDU's is glued to the inside. The painted surface has been scratched and lightly dented through use and age, revealing the aluminium beneath, and the straps have faded slightly.

Accompanying the chest plate is a photocopied letter of identification from English, a photocopy of the design, a photocopy of English's own drawing and a photocopy of a continuity sheet detailing the armour components supplied by English to the production.

Dimensions: 14 cm x 42 cm x 45 cm (5 1/2" x 16 1/2" x 17 3/4")

£10,000-15,000



24. Ripley's (Sigourney Weaver) Prison Uniform †Δ

ALIEN³ (1992)

Ripley's (Sigourney Weaver) prison uniform from David Fincher's sci-fi horror *Alien³*. After being rescued from her crashed escape pod, Ripley was dressed in a prison uniform for the duration of the film. Stains on the jacket screen-match to the scene in which Ripley begged Dillon (Charles S. Dutton) to kill her, thus destroying the embryo of the Alien Queen she carried inside her.

Faded and production-distressed to emphasise the stark prison setting, the costume consists of a green coat, a brown jacket and matching cotton T-shirt and trousers. The coat features an embroidered patch on the front-left breast showing an eagle carrying handcuffs surrounded by the text "Serenity Through Confinement", and a red circular patch on the right arm with the famous Weyland-Yutani logo above the number 161 (referring to the planet's name Fiorina "Fury" 161). The oversized T-shirt also displays the Weyland-Yutani logo printed across its back. The cotton jacket has a stitched cross-pattern design that continues across the garment's body over the hood. A length of tape is adhered to the jacket's hood from use on the production, to help secure it to the back.

Adhered to the inside of each component of the costume are Weyland-Yutani tags. The coat, jacket and shirt all have handwritten labels in various inks reading "Ripley". The trousers also have a label showing "Ripley Double" and the letter "S" written on the waistband. Well-used, the clothing has small abrasions, tears and stains visible throughout.

£6,000-8,000



Kobal/REX/Shutterstock

25. Alien Queen Puppet M**AVP: ALIEN VS PREDATOR (2004)**

An Alien Queen puppet from Paul W.S. Anderson's sci-fi action film *AVP: Alien vs. Predator*. A cable-controlled puppet version of the creature was used for scenes in which the Queen was imprisoned in her chamber, breaking free from her restraints to rampage through the ancient pyramid.

The 1/3 scale Alien Queen puppet was built by Academy Award®-winning special effects company ADI (Amalgamated Dynamics Inc), who worked on many films in the Alien franchise. A combination of practical and digital techniques were used to bring the fearsome creatures in this film to life.

Housing an internal metal frame and mounted on a bracket, the piece displays a foam-latex skin with the Queen's distinctive fanned head, two pairs of arms and multiple spines running down her back. The fibreglass head of the puppet consists of the crown and a pronounced jaw, adorned with a set of clear resin teeth. The creature is finished in shades of grey and metallic blue paint, maintaining the colour scheme exhibited when the creature first appeared in *Aliens*. Accompanying the puppet are four spare foam spine pieces with metal rods at their base, showing where the pieces would have been attached to the body.

A set of six animatronic control cables run from inside the creature's body towards the back of the puppet, where they have been cut and neatly tied. The cables controlled several components of the Queen, including the arms, legs and jaw. The puppet displays signs of use, including minor paint wear, remnants of glue on the arms and damage to the tip of the tail. A slanted metal bracket is attached, allowing the puppet to be displayed upright on a black, custom-made base which features the film's title artwork at the front. Dimensions: 81 cm x 53 cm x 92 cm (32" x 21" x 36 1/4")

This item contains mechanical components. While every effort is made to describe them accurately, no guarantee or warranty is made as to the functionality, lifespan or safety of those components. It is entirely incumbent on the new owner to satisfy themselves as to their safe use and maintenance.

£20,000 – 30,000



26. John Milner's (Paul Le Mat) THX 138 Licence Plate M

AMERICAN GRAFFITI (1973)

John Milner's (Paul Le Mat) THX 138 licence plate display from George Lucas' coming-of-age comedy *American Graffiti*. John Milner's yellow 1932 Ford Deuce Coupe had a yellow licence plate that read "THX 138", a reference to Lucas' first film THX 1138. This started the in-joke of referencing THX 1138 in Lucas' later films.

Made of cardboard, this bespoke licence plate is yellow, labeled for the state of California, and dated 1956. It lacks the weathering seen on screen, as it is a production back-up. This piece is housed in a custom-made metal frame that is aged to appear like rusting steel. Originally obtained from a member of the production crew, the licence plate shows minimal signs of wear and is in very fine overall condition.

Dimensions (in frame):
42 cm x 5 cm x 27 cm (16 1/2" x 2" x 10 1/2")

£4,000-6,000



27. Production-Used Clapperboard and Cast-Autographed Banner M

ARMAGEDDON (1998)

A production-used clapperboard and cast-autographed banner from *Armageddon*. The clapperboard has an acrylic slate with red etched details, including the movie title and the names of producer Jerry Bruckheimer, director Michael Bay and cinematographer John Schwartzman. Space has been left for crew to handwrite the scene, take and date.

The wide landscape poster features six of the key cast with their character names and reasons for joining the mission, and has been autographed by Billy Bob Thornton and Steve Buscemi in black marker. The poster is folded and in good condition.

Dimensions (clapperboard): 2 cm x 28 cm x 24 cm (3/4" x 11" x 9 1/2");
(poster): 131 cm x 53 cm (55 1/2" x 20 3/4")

£600-800

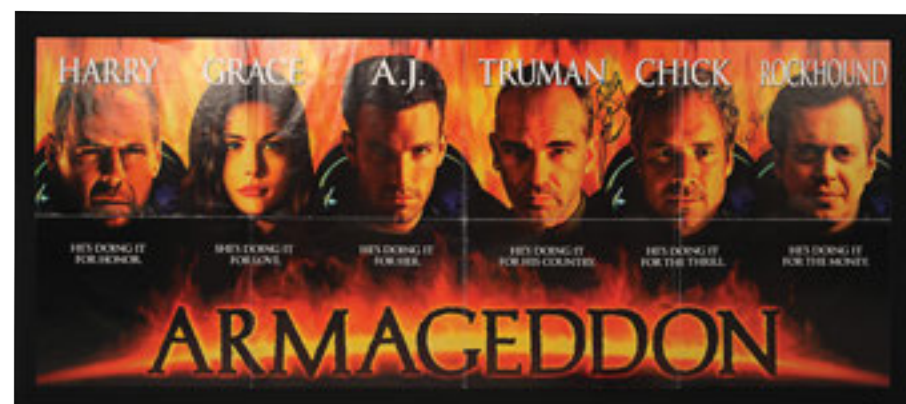

28. Light-Up Armadillo Model Miniature M

ARMAGEDDON (1998)

A light-up Armadillo model miniature from Michael Bay's sci-fi adventure *Armageddon*. Multiple model miniatures were used for the film's visual-effects sequences. This model would have been used for shots towards the end, which showed the Armadillo traversing the asteroid surface.

The Armadillo model is made of resin and finished in faux-silver paint. The vehicle features detailed paneling across the cab section, six independently mounted wheels, and a top-mounted drilling arm. Made of dense foam, the uneven asteroid base displays cast-in surface markings and intentionally cut-out sections, and has been painted in various shades of green.

Presented on a custom-made display, the lot contains internal electronics, powered by two buttons on the base which illuminate three small lights on the vehicle and the film's title artwork. An exposed cable runs down into the base and minor paint wear is present on the asteroid surface.

Dimensions: 45 cm x 25 cm x 37 cm (17 3/4" x 10" x 14 3/4")

This item contains electronic components. While every effort has been made to describe them accurately, no guarantee or warranty is made as to the functionality, lifespan or safety of those components. It is entirely incumbent on the new owner to satisfy themselves as to their safe use and maintenance.

£3,000-5,000



29. Light-Up Armadillo Cab Model Miniature M

ARMAGEDDON (1998)

A light-up Armadillo cab model miniature from Michael Bay's sci-fi adventure *Armageddon*. This model was used primarily for the sequence in which A.J. (Ben Affleck), Andropov (Peter Stormare) and Bear (Michael Clarke Duncan) attempted their "Evel Kniesel" jump over a canyon on the asteroid.

This front cab section was attached to a complete model of the entire vehicle. The back is removable, so the positions of the characters inside could easily be repositioned for each shot. The cab had to be repaired on set after numerous collisions with model asteroids which occurred as part of the sequence.

The detailed model consists of a timber frame with an exterior fabricated from a combination of metal and resin. It is dressed with various decal transfers, metal pipes and transparent windows. Small green and red LEDs, powered by a 5-volt

DC power supply, illuminate the inside of the cab, and a metal Gatling gun is adhered to the front.

Housed inside the model is a figure representing A.J. sitting in the cockpit, alongside an additional seat. The lot displays paint wear from production use, minor scratches on the windows and corrosion on the metal gun barrels. Exposed cables are present at the front, and the piece is wired with a plug to power it. Dimensions: 45 cm x 42 cm x 50 cm (17 ¾" x 16 ½" x 19 ¾")

This item contains electronic components. While every effort has been made to describe them accurately, no guarantee or warranty is made as to the functionality, lifespan or safety of those components. It is entirely incumbent on the new owner to satisfy themselves as to their safe use and maintenance.

£4,000 – 6,000



30. Lev Andropov's (Peter Stormare) Stunt Spacesuit M

ARMAGEDDON (1998)

Lev Andropov's (Peter Stormare) stunt spacesuit from Michael Bay's sci-fi adventure *Armageddon*. After surviving the crash of the Independence, the Russian cosmonaut wore his spacesuit while he navigated the asteroid — including the daring Evel Kniesel gorge jump — before making his way back to the Freedom team to help plant the nuclear bomb.

Used for action sequences, the suit comprises a top and trousers fastened together at the waist, decorated with foam and metal components; a torso panel with LED lights and ventilation systems; a foam collar; a pair of gloves and boots; and a belt fitted with painted foam battery cylinders. Handwritten labels are adhered to the inside of the top, trousers, belt and gloves, reading "Lev Stunt" and "Lev Stunt Clean". Completing the suit is a replica helmet with a metal frame, clear plastic visor and foam interior. Distressed for production use, the costume shows paint chips, wear and loose threads throughout.

This item contains electronic components. While every effort has been made to describe them accurately, no guarantee or warranty is made as to the functionality, lifespan or safety of those components. It is entirely incumbent on the new owner to satisfy themselves as to their safe use and maintenance.

£4,000-6,000



31. A.J.'s (Ben Affleck) Spacesuit M

ARMAGEDDON (1998)

A.J.'s (Ben Affleck) spacesuit from Michael Bay's sci-fi adventure *Armageddon*. The hot-headed drill operator wore his spacesuit as he traversed the asteroid's surface to assist Harry (Bruce Willis) and the Freedom crew in saving Earth from its impending destruction.

Affleck was one of the first actors to guinea-pig the space suits, which weigh over 30kg (approximately 70lbs) and cost more than \$1 million to design and create, after extensive redesigns at Bay's personal request. Affleck essentially tested how the spacesuit looked and fit before a nervous Willis, who started late on the film, came to the set.

Constructed primarily from a heavy-weave, nylon-like material, the costume consists of a helmet; a top and trousers zipped together at the waist; a resin, foam-lined collar; a front-and-back pack; a pair of gloves with metal locking rings; a utility belt; and a pair of modified Adidas boots covered in dress-up components.

The helmet is made of grey fibreglass with a wide acrylic visor allowing clear visibility. Each component features highly detailed metal, plastic and resin adornments. Handwritten labels, reading "AJ", are located on both parts of the pack and on the top and trousers, with a label reading "Ben Affleck AJ Clean" on the belt.

Powered by an elaborate battery system, electronic components are fitted to the helmet and chest pack that allow them to illuminate with multiple LEDs. Demisting fans are housed inside the pack, linking to the helmet, to supply the actor with plenty of air and ventilation while performing on set. These particular modifications were added after Bay had found Affleck almost passing out due to a lack of air supply.

Distressed for use on the production, giving the appearance of heavy wear from navigating the unforgiving asteroid terrain, the suit shows signs of deterioration on the foam components, with some breaks, cracks and small missing parts throughout. Dimensions (displayed): 42 cm x 70 cm x 200 cm (16 1/2" x 27 1/2" x 79")

This item contains electronic components. While every effort has been made to describe them accurately, no guarantee or warranty is made as to the functionality, lifespan or safety of those components. It is entirely incumbent on the new owner to satisfy themselves as to their safe use and maintenance.

£15,000-20,000



**32. Lin's (Michelle H. Lin)
Hero Sword †Δ**

ASSASSIN'S CREED (2016)

Lin's (Michelle H. Lin) hero sword from Justin Kurzel's video-game adaptation *Assassin's Creed*. Lin obtained her sword from the display cabinets of the Abstergo facility and used it to fight off the security guards alongside Cal Lynch (Michael Fassbender) and their fellow assassin prisoners.

The sword comprises a steel blade with cast-in Chinese dragon emblems, a resin grip and ornate metal hardware for the guard and pommel. The dark red scabbard features matching faux-gold detailing, with the Brotherhood of Assassins emblem incorporated into the design. The blade of the sword shows minor markings and scratches, and the scabbard displays wear to the paint finish from production use.

Dimensions: 120 cm x 7.5cm x 4 cm (47 ¼" x 3" x 1 ¾")

£1,000-1,500



**33. Ojeda's (Hovik Keuchkerian)
Hero Sword †Δ**

ASSASSIN'S CREED (2016)

Ojeda's (Hovik Keuchkerian) hero sword from Justin Kurzel's video-game adaptation *Assassin's Creed*. Torquemada's (Javier Gutiérrez) chief enforcer used his sword to battle his archenemies Aguilar (Michael Fassbender) and Maria (Ariane Laped) in 15th-century Spain.

Made of aluminium, the sword features a plated faux-silver blade with engraved fullers and an ornately decorated cross guard. The grip is made of rubber over a rigid core with incorporated wire detailing, and the pommel of the sword forms the head of a bearded man, with a brass-coloured paint finish. The sword shows some slight wear from use and some minor corrosion on the cross guard.

Dimensions: 104 cm x 19 cm x 3 cm (41" x 7 ½" x 1 ½")

£1,000-1,500

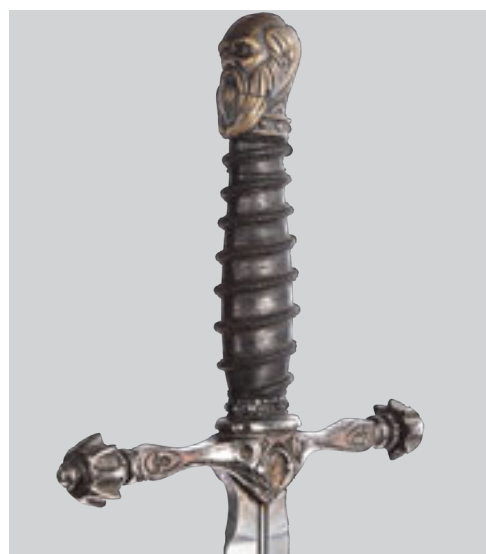

**34. Lara's (Octavia Selena Alexandru)
Ancient Assassin's Book Ω**

ASSASSIN'S CREED (2016)

Lara's (Octavia Selena Alexandru) ancient Assassin's book from Justin Kurzel's video-game adaptation *Assassin's Creed*. Lara gave Callum (Michael Fassbender) a centuries-old Assassin's handbook in a deleted scene.

The book is made of leather and parchment paper, with the front cover stamped with the Assassin's Brotherhood insignia. Thirty-one parchment pages are bound inside, featuring alternating printed pages that present hand-drawn illustrations of the assassins' hidden-blade weapon. The book is distressed to appear old and worn, but remains in very fine condition. Dimensions: 27 cm x 2 cm x 34 cm (10 ¾" x ¾" x 13 ¼").

£600-800



**35. Aguilar's (Michael Fassbender)
Wristblade †Δ**

ASSASSIN'S CREED (2016)

Aguilar's (Michael Fassbender) wristblade from Justin Kurzel's video-game adaptation *Assassin's Creed*. Aguilar wore his wristblade throughout the film as he and his fellow assassin Maria (Ariane Laped) battled the 15th-century Templars led by Torquemada (Javier Gutiérrez) and his henchman Ojeda (Hovik Keuchkerian).

The mount of the wristblade is made of metal, with additional components made of dense rubber, finished in faux silver to produce the appearance of polished steel. Ornately detailed, the wristblade housing has detailing applied — hand-painted to replicate worked ivory, with incorporated shades of metallic purple and blue. Cast-in patterns decorate the blade and two black straps are attached to the mount. A strip of brown leather is adhered to the back and features the handwritten text "Hard Left". The weapon shows minor paint wear and the rubber casing has come away on parts of the mount, exposing glue remnants.

Dimensions: 29 cm x 9 cm x 4 cm (11 ½" x 3 ¾" x 1 ¾")

£1,500-2,500



**36. Cal Lynch's (Michael Fassbender)
Modern Wristblade †Δ**

ASSASSIN'S CREED (2016)

Cal Lynch's (Michael Fassbender) modern wristblade from Justin Kurzel's video-game adaptation *Assassin's Creed*. Cal used his wristblade during a Templar ceremony, in which he slit Alan Rikkin's (Jeremy Irons) throat to retrieve the Apple of Eden. The surviving assassin prisoners of the Abstergo facility sneaked different components of the wristblade through security at the Templar Sanctuary in London.

Constructed from dense rubber, the wristblade mount displays a printed carbon fibre-like finish and the weapon has been finished in black. The resin housing features intricate detailing, including a cast-in honeycomb pattern, and two black utility straps with foam padding are adhered to the back. Fitted within is a special effects blade, which features internal metal tubing, designed to use with a blood line. The wristblade displays paint wear and damage to the edge of the blade from production use.

Dimensions: 31 cm x 11 cm x 5 cm (12 ¼" x 4 ½" x 2")

£1,000-1,500



**37. Aguilar's (Michael Fassbender)
Hero Executioner Dagger †Δ**

ASSASSIN'S CREED (2016)

Aguilar's (Michael Fassbender) hero executioner dagger from Justin Kurzel's video-game adaptation *Assassin's Creed*. Aguilar used the dagger — planted at his feet by one of his executioners — to break his bonds and free himself and Maria (Ariane Laped), leading to a chase through the streets and rooftops of Seville.

Made of cast metal, the dagger features a leather-wrapped grip with a brass-coloured guard covered in floral detailing. The weapon is made to look well-used, with paint applied to the blade to give it a worn, corroded appearance and additional wear applied to the leather grip binding. Distressed for use, it remains in very good condition.

Dimensions: 32.5 cm x 7 cm x 3 cm (12 ¾" x 2 ¾" x 1 ¼")

£600-800

38. Aguilar's (Michael Fassbender) SFX Templar Sword †Δ

ASSASSIN'S CREED (2016)

Aguilar's (Michael Fassbender) SFX Templar sword from Justin Kurzel's video-game adaptation *Assassin's Creed*. Aguilar grabbed a wedged Templar sword from a wooden post as he and Maria (Ariane Labeled) escaped execution, using it to fight off numerous Templars.

The sword displays a polished aluminium blade with a defined fuller. Three nails, used to allow the blade to stick firmly into the wood, protrude from one side. Strips of brown leather are wrapped around the grip and the Holy Cross of the Templar order is incorporated into the pommel and highlighted in red. Intentional distressing has been applied to the sword to produce a battle-worn appearance, and the lot shows minor scratches.

Dimensions: 107 cm x 17.5 cm x 3 cm (42 ¼" x 7" x 1 ¼")

£600-800

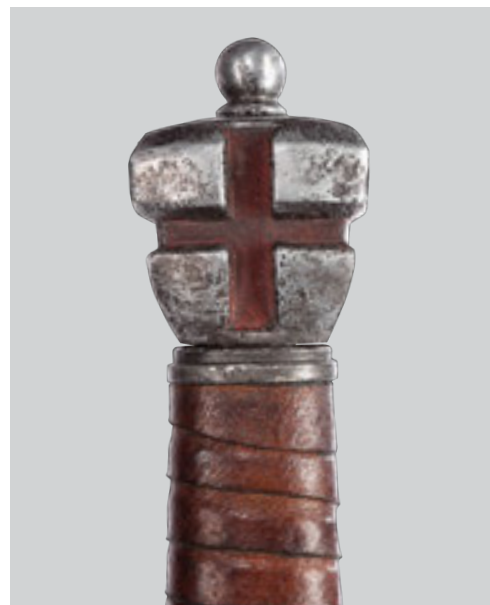

39. Aguilar's (Michael Fassbender) Stunt Hidden-Blade Leather Bracers Ω

ASSASSIN'S CREED (2016)

Aguilar's (Michael Fassbender) stunt hidden-blade leather bracers from Justin Kurzel's video-game adaptation *Assassin's Creed*. Aguilar and his descendant, Callum, wore bracers with hidden blades during numerous action sequences throughout the film. Designed by the ancient Assassin's Brotherhood, hidden blades were used in close-quarters combat.

The bracers are made of felt-lined leather, with the hidden-blade contraptions made of urethane for safety purposes. Both bracers feature intricately woven leather exteriors, and close with Velcro and elastic loops. The cast rubber hidden blades are painted in shades of silver and bronze to resemble mechanical construction. Both bracers show "Michael" and "Rubber" handwritten inside with black ink. The lot shows intentional aging but remains in very fine condition.

Dimensions: 30 cm x 8 cm x 32 cm (12" x 3" x 12 ½")

£3,000-5,000



40. Fat Bastard (Mike Myers) Make-up Test Ω

AUSTIN POWERS IN GOLDMEMBER (2002)

A Fat Bastard (Mike Myers) make-up test made for the production of Jay Roach's spy comedy *Austin Powers in Goldmember*. This sequel found Myers reprising his role as Fat Bastard.

The make-up test has been applied to a fibreglass form that is a cast of Myers in the character of Fat Bastard. The piece is painted in great detail, in order to serve as a test for the make-up and reference for artists on set. The bust is completed with a set of faux eyebrows, faux eyelashes, faux sideburns and a lace wig of faux hair. This piece shows some signs of wear, including missing eyelashes on the left side, but it remains in fine overall condition.

Dimensions: 49.5 cm x 38 cm x 21.5 cm (19 ½" x 15" x 8 ½")

£2,000-3,000

41. Dr. Evil (Mike Myers) Make-up Test Ω

AUSTIN POWERS IN GOLDMEMBER (2002)

A Dr. Evil (Mike Myers) make-up test made for the production of Jay Roach's spy comedy *Austin Powers in Goldmember*. This third film in the *Austin Powers* series found Mike Myers reprising his role as Dr. Evil.

The make-up test consists of a biscuit-foam cast of Mike Myers in the character of Dr. Evil. The piece is painted in detail, in order to serve as both a test for the make-up and as a reference for the make-up artists on set. The bust features faux eyebrows and eyelashes. This piece shows some signs of wear, including a small crack to the paint at the bottom right of the bust, but it remains in fine overall condition.

Dimensions: 49.5 cm x 35.5 cm x 21.5 cm (19 ½" x 14" x 8 ½")

£2,000-3,000

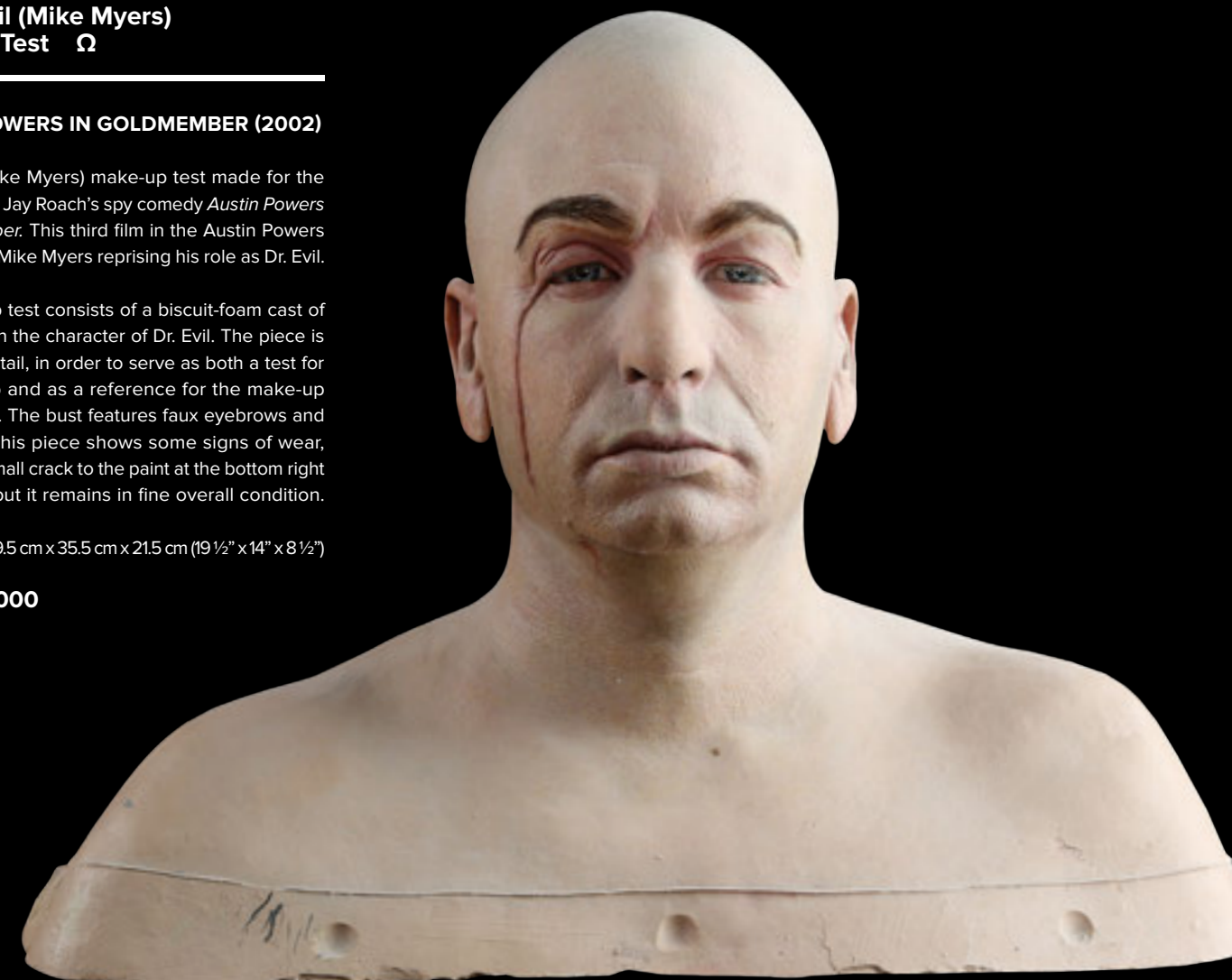

42. Doc Brown's (Christopher Lloyd) SFX Wind-Up Cadillac Ω

BACK TO THE FUTURE (1985)

Doc Brown's (Christopher Lloyd) SFX wind-up Cadillac from Robert Zemeckis' time-travel adventure *Back to the Future*. While demonstrating a plan to send Marty (Michael J. Fox) back to the future, Doc Brown accidentally lit his model car on fire.

This piece screen-matches the burning car via specific markings made by the fire. Additionally, the Cadillac logo on the right of the vehicle is damaged in the same way as seen on screen.

This car is made of pressed steel and was originally a wind-up toy car modelled after a 1950s-era Cadillac. It has been modified by production to suit the needs of the scene. A wire has been added to the boot to simulate the rod the DeLorean needed to utilise the power of lightning. This wire fastens to the car via a wooden base that is permanently attached.

On the underside of the car, a black wire has been attached via hot glue. Though heavily burnt, the interior of the car still retains wires and material used to ignite the fire for the sequence. The vehicle shows intentional wear from production use and remains in very fine overall condition.

Dimensions: 28 cm x 9 cm x 13 cm (11" x 3 1/2" x 5")

£10,000-15,000



43. Oversized Fading Insert Photograph — Marty's Siblings Disappearing Ω

BACK TO THE FUTURE (1985)

An oversized fading insert photograph from Robert Zemeckis' time-travel adventure *Back to the Future*, which shows Marty McFly's (Michael J. Fox) siblings disappearing. Marty's brother and sister faded away from his photograph when he unintentionally changed the past. Large-scale versions of Marty's wallet photo were used by Industrial Light & Magic for close-up insert shots, although this particular stage of the fading photograph was ultimately unseen in the film.

Printed on Kodak photo paper, the picture shows Marty standing by a well, with his siblings Linda (Wendy Jo Sperber) and Dave (Marc McClure) fading away. The photograph is in very fine condition.

Dimensions: 37.5 cm x 27 cm (14 3/4" x 10 3/4")

Please note this lot is sold without copyright, reproduction rights, licensing agreements or any other type of legal release.

£3,000-£5,000



44. Oversized Fading Insert Photograph — Marty Disappearing Ω

BACK TO THE FUTURE (1985)

An oversized fading insert photograph from Robert Zemeckis' time-travel adventure *Back to the Future*, which shows Marty McFly (Michael J. Fox) disappearing. Marty and his siblings faded away from his photograph when he unintentionally changed the past. Large-scale versions of Marty's wallet photo were used by Industrial Light & Magic for close-up insert shots.

Printed on Kodak photo paper, the picture shows a disappearing Marty standing by a well, with his siblings Linda (Wendy Jo Sperber) and Dave (Marc McClure) completely faded away. The photograph is in very fine condition.

Dimensions: 37.5 cm x 27 cm (14 3/4" x 10 3/4")

Please note this lot is sold without copyright, reproduction rights, licensing agreements or any other type of legal release.

£3,000- £5,000



45. "OUTATIME" DeLorean Licence Plate Ω

BACK TO THE FUTURE (1985)

An "OUTATIME" DeLorean licence plate made for Robert Zemeckis' time-travel adventure *Back to the Future*. The DeLorean's licence plate was seen on the rear of the vehicle throughout the film.

This piece is made of metal and emulates the look of a real California licence plate from the period. It has a registration tag dated 1986 in the top left corner, and the "OUTATIME" letters stand out in relief, having been stamped from the back. Produced for the various vehicles used in the movie, this licence plate is unique, as various markings match it to the plate shown on the back of the Japanese souvenir program published to promote the film. A copy of this publication is included with the plate. This piece shows signs of wear, such as the markings mentioned above, and is in fine condition.

Dimensions: 30.5 cm x 15 cm (12" x 6")

£10,000-15,000



46. Ron Cobb Hand-Drawn DeLorean Interior Artwork Ω

BACK TO THE FUTURE (1985)

Hand-drawn artwork depicting the interior of the DeLorean time machine from Robert Zemeckis' time-travel adventure *Back to the Future*. Rendered by Ron Cobb, the illustration is among the earliest designs for Doc Brown's (Christopher Lloyd) stylish time machine.

Drawn with coloured pencil on illustration board, the illustration depicts the interior view from the driver's-side door, with an array of electrical equipment surrounding the driver's seat. The artwork shows minor wear due to use and age, but remains in very fine condition.

Dimensions: 42.5 cm x 33 cm (17" x 13")

Please note this lot is sold without copyright, reproduction rights, licensing agreements or any other type of legal releases.

£3,000-5,000

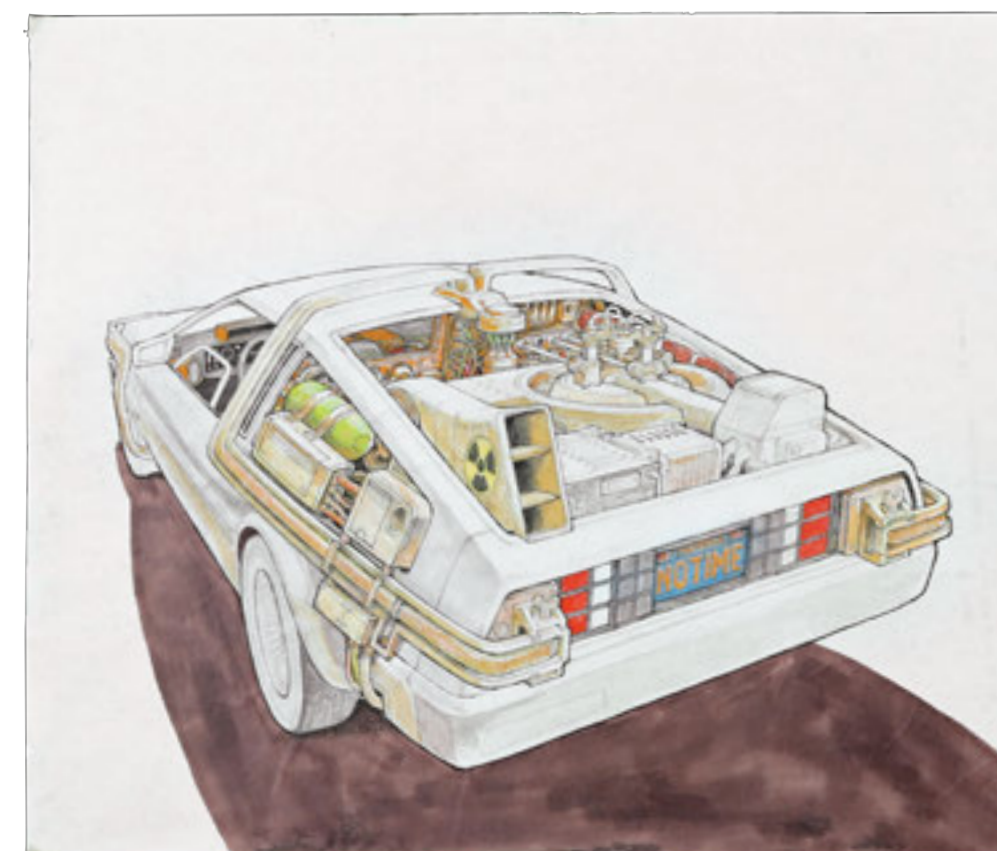
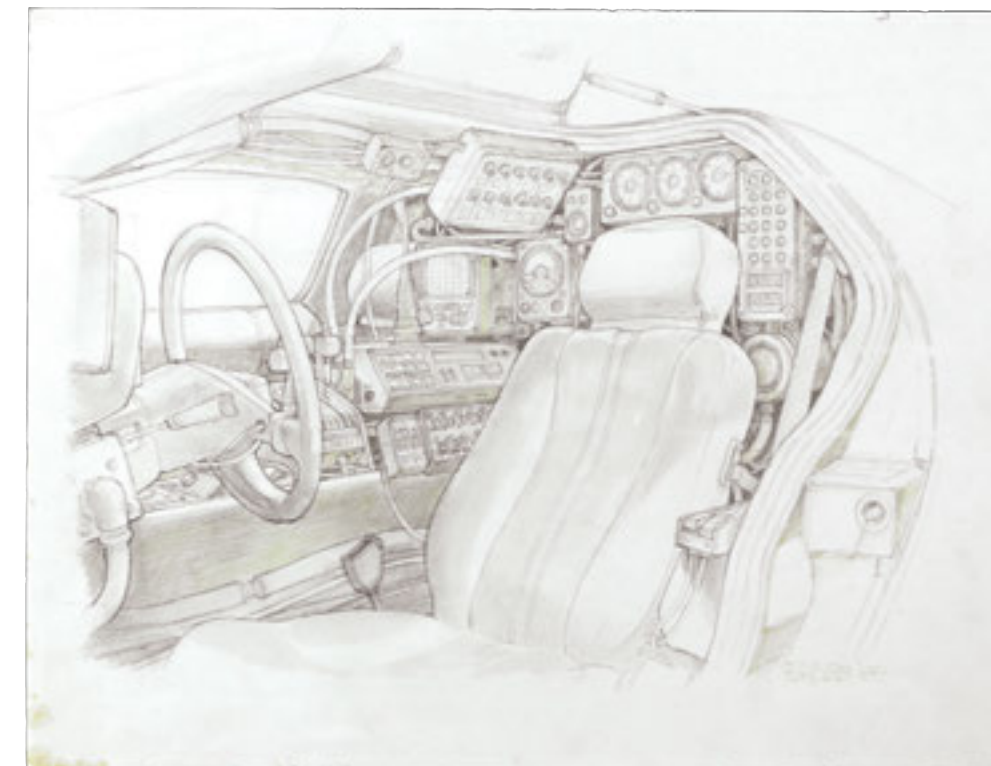

47. Ron Cobb Hand-Drawn DeLorean Coloured Exterior Artwork Ω

BACK TO THE FUTURE (1985)

Hand-drawn artwork depicting the exterior of the DeLorean time machine from Robert Zemeckis' time-travel adventure *Back to the Future*. Rendered by Ron Cobb, the illustration is one of the earliest designs for Doc Brown's (Christopher Lloyd) stylish time machine.

Drawn with coloured pencil and marker on paper that is mounted to illustration board, the illustration depicts a reverse exterior view of the DeLorean. This early concept notably shows only one steam vent on the back of the vehicle, with the licence plate reading "NO TIME".

The artwork shows minor wear due to use and age, but remains in very fine condition.

Dimensions (artwork): 33 cm x 28 cm (13" x 11");
(artwork board): 41 cm x 33 cm (16" x 13")

Please note this lot is sold without copyright, reproduction rights, licencing agreements or any other type of legal releases.

£1,500-2,500

48. Ron Cobb Hand-Drawn DeLorean Front and Rear View Artwork Ω

BACK TO THE FUTURE (1985)

Hand-drawn artwork depicting the front and back views of the DeLorean from Robert Zemeckis' time-travel adventure *Back to the Future*. Rendered by Ron Cobb — a production designer who helped design the time machine in a special consultant role — this illustration is one of the earliest designs for Doc Brown's (Christopher Lloyd) stylish invention.

Drawn with pencil and pen on vellum drafting grid paper and taped to an illustration board, the illustration shows an early concept for the DeLorean from front and back angles. This early concept includes labels identifying various unique components attached to the DeLorean.

The artwork has "BACK TO THE FUTURE" and "THE DELOREAN TIME MACHINE" written at the bottom corners in pencil, and is signed "R. COBB '84" at the bottom corner of the vehicle. The artwork shows minor wear due to use and age, with wrinkles to the paper. However, the piece remains in very fine condition.

Dimensions (artwork): 61 cm x 46 cm (24" x 18"); (illustration board): 76 cm x 51 cm x 1 cm (30" x 20" x ¼")

Please note this lot is sold without copyright, reproduction rights, licensing agreements or any other type of legal releases.

£3,000-5,000

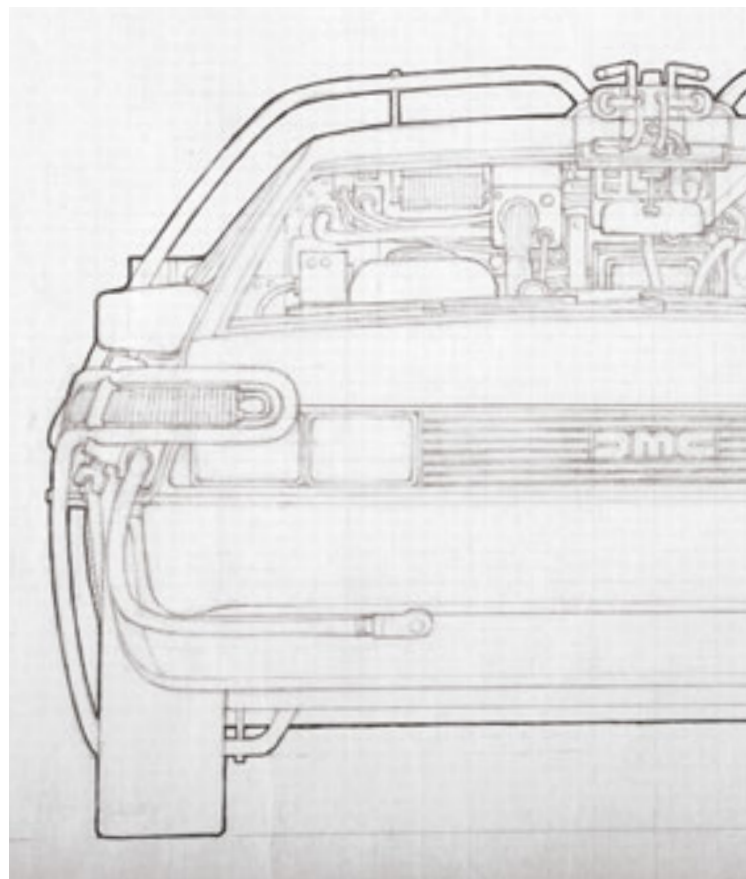

49. Ron Cobb Hand-Drawn DeLorean Time Machine Overhead Plan Artwork Ω

BACK TO THE FUTURE (1985)

Hand-drawn artwork depicting an overhead plan of the DeLorean from Robert Zemeckis' time-travel adventure *Back to the Future*. Rendered by Ron Cobb — a production designer who helped design the time machine in a special consultant role — this illustration is one of the earliest designs for Doc Brown's (Christopher Lloyd) stylish invention.

Drawn with pencil on vellum drafting grid paper and taped to an illustration board, the illustration shows an early concept for the DeLorean from a top-down angle, with an array of electrical equipment over the back third of the vehicle. This early concept notably shows only one steam vent at the rear of the vehicle, and includes labels identifying the various unique components attached to the DeLorean.

The artwork has "BACK TO THE FUTURE" and "THE DELOREAN TIME MACHINE" written at the bottom corners in pencil, and is signed "R. COBB '84" at the bottom corner of the vehicle. The artwork shows minor wear due to use and age, with wrinkles to the paper. However, the piece remains in very fine condition. Dimensions (artwork): 61 cm x 46 cm (24" x 18"); (illustration board): 76 cm x 51 cm x 1 cm (30" x 20" x ¼")

Please note this lot is sold without copyright, reproduction rights, licensing agreements or any other type of legal releases.

£3,000-5,000

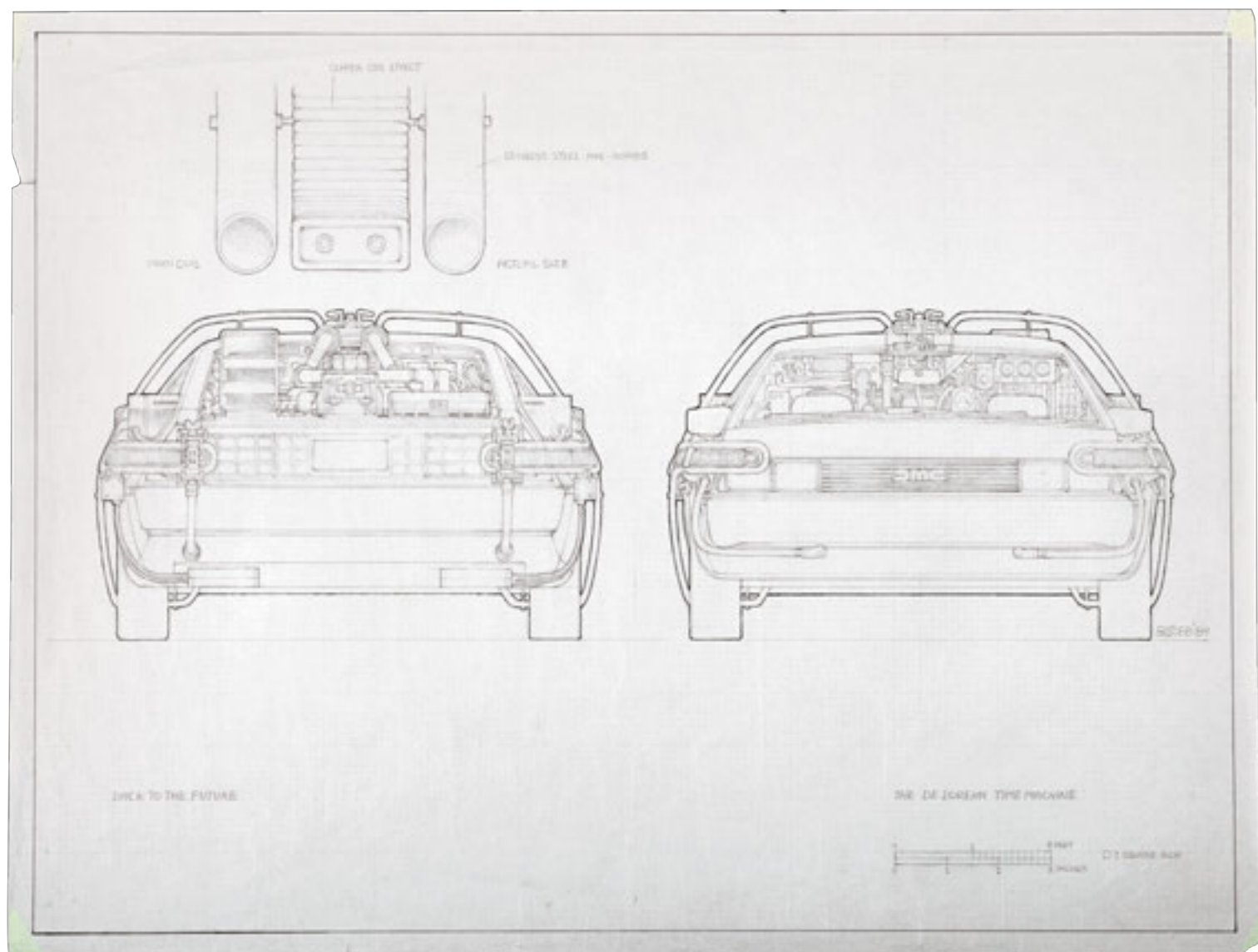
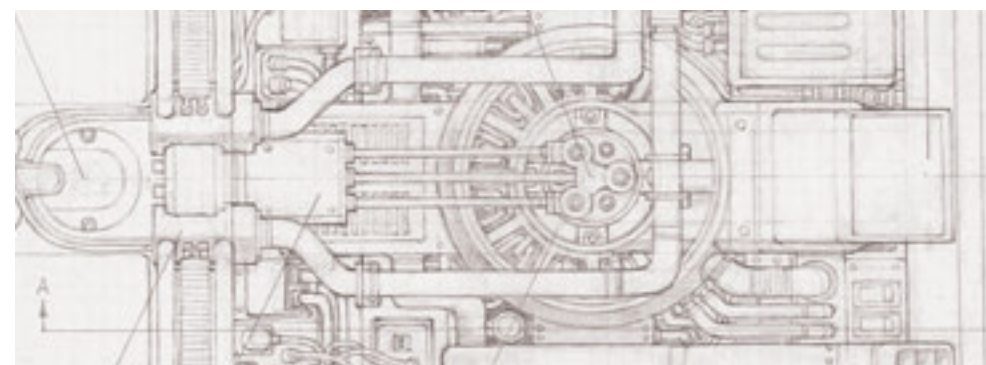
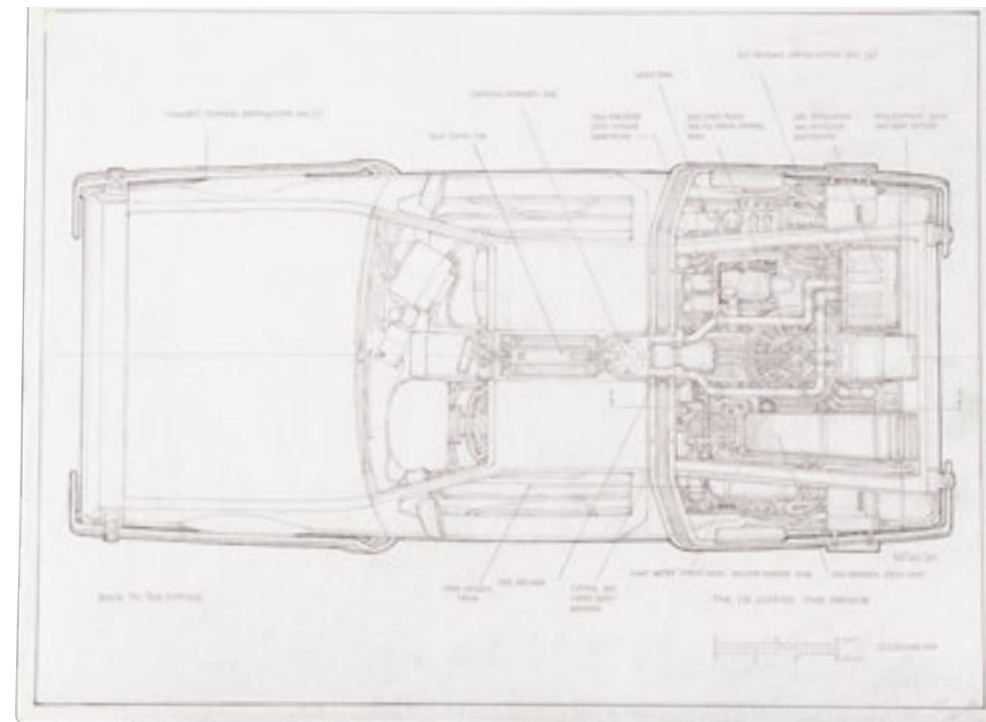

50. Marty McFly's (Michael J. Fox) Oversized Western Union Letter Ω

BACK TO THE FUTURE PART II (1989)

Marty McFly's (Michael J. Fox) oversized Western Union letter from Robert Zemeckis' time-traveling adventure sequel *Back to the Future Part II*. After he saw the DeLorean struck by lightning with Doc Brown (Christopher Lloyd) inside, Marty was approached by a Western Union worker with a letter. Sent by Doc Brown in 1885, this letter informed Marty of the scientist's fate.

This oversized letter was produced for insert shots showing the letter's contents. Film productions utilise oversized pieces like this in order to produce better close-ups on small items. It is printed on large paper made to look browned from age and features a typeface that resembles handwriting. Notably, the paper shows some water stains from filming. This piece is folded in thirds and is in fine overall condition.

Dimensions: 87.5 cm x 58.5 cm (43 ½" x 23")

Please note this lot is sold without copyright, reproduction rights, licensing agreements or any other type of legal releases.

£2,000-3,000

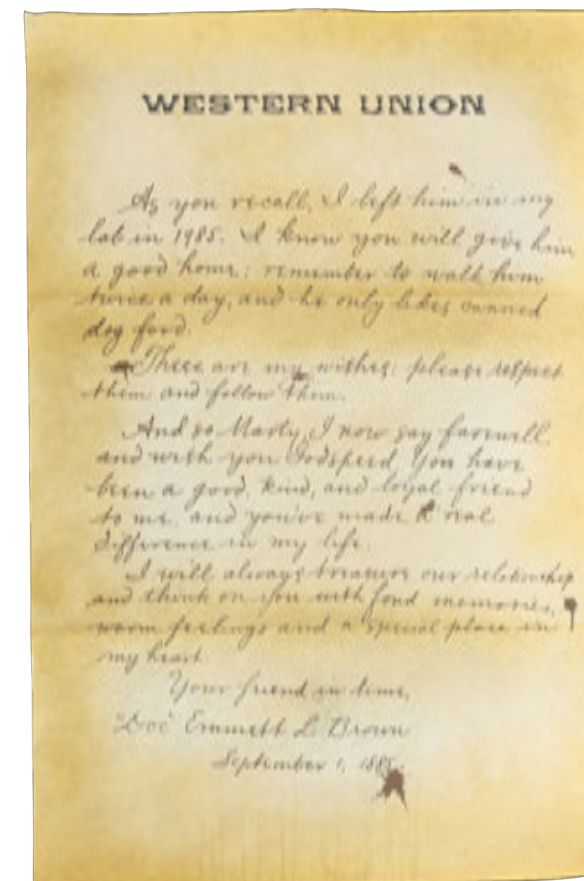

51. Marty McFly's (Michael J. Fox) Hoverboard Ω

BACK TO THE FUTURE PART II (1989)

Marty McFly's (Michael J. Fox) hoverboard from Robert Zemeckis' sci-fi sequel *Back to the Future Part II*. Marty frequently used his signature hoverboard throughout the second and third films in the Back to the Future trilogy. A number of prop hoverboards were created for the film, in either lightweight Styrofoam or in solid wood, with varying styles of construction and degrees of detail.

This Styrofoam version features a photo-type finish, as opposed to a lenticular finish that was used on other boards. The board is outfitted with neon-green and pink-coloured Velcro on top, and includes a furry pink foot strap over the back footpad. At the top front of the board is a small hole for the handlebars, which Marty removed upon taking the board from a child. The underside features plastic hover pads and casing screwed in place. The hoverboard shows wear to the paint and Styrofoam due to production use and age, but remains in very fine condition.

Dimensions: 72 cm x 20 cm x 8 cm (28 ¼" x 8" x 3")

£30,000-50,000



52. Universal Studios Florida Promotional Full-Size Practical Replica Time-Travelling DeLorean Car M

BACK TO THE FUTURE TRILOGY (1985 - 1990)

A full-size, practical replica time-travelling DeLorean car, as seen in the *Back to the Future* trilogy. Doc Brown's (Christopher Lloyd) remarkable time machine was used by Marty McFly (Michael J. Fox) at numerous points during the three *Back to the Future* films, as our heroes travelled as far back as 1885 and as far forward as 2015, constantly trying to unravel the various problems they themselves caused.

This incredibly detailed replica has been painstakingly assembled, with every care and effort taken to accurately represent the vehicle featured throughout the *Back to the Future* trilogy. Starting life as a 1981 DeLorean DMC-12, the car was meticulously converted by ex-NASA engineer Bruce Coloumbe to the highest possible standards.

Every added component functions as it does in the movies (apart from enabling actual time travel, of course). Dates can be inputted into the time circuits while producing the correct sound effects. Should one be driving and hit 88mph, time-travel mode will activate, causing the Flux Capacitor to illuminate and sound effects to play (legal disclaimer: driving at 88 mph is illegal in most countries and is generally frowned upon). The time-travel mode feature is also accessible via the remote control while the car is stationary. The Flux Capacitor, fluxes, doors and Mr. Fusion make the correct noises when opened.

The car includes a fog machine hooked up to the rear vents, and numerous sound clips can be played via internal and external speakers, all activated via remote control. A set of hover wheels are included which, when clipped over the standard wheels, give the illusion of flying. The final addition is a replica Mattel Hoverboard which stands to the side of the car for the complete time-travel experience. The car's heat sink has been autographed by Christopher Lloyd and franchise co-creator Bob Gale. A spare heat sink is also provided.

This car was extensively used for promotional purposes at Universal Studios in Orlando, Florida in 2011 and 2012. Photographs of it on display and at other events — including use in the UK for Microsoft, Pepsi/Uber, Secret Cinema, Giff Gaff and many more — are included in a reference folder. The album also includes an operator's manual, wiring diagrams, legal documents, purchase receipts and importation paperwork.

The DeLorean is functioning and running. It is a UK road-legal vehicle and is currently registered to the owner in England. Its MOT (Ministry of Transport) certificate expired in May and it is currently SORN and declared as off the road. Legal transfer of title will need to take place before delivery can be arranged. Transportation and shipping quotes should be acquired prior to bidding.

Dimensions: 435 cm x 200 cm x 145 cm (171 ¼" x 78 ¾" x 57")

This item contains electronic components. While every effort has been made to describe them accurately, no guarantee or warranty is made as to the functionality, lifespan or safety of those components. It is entirely incumbent on the new owner to satisfy themselves as to their safe use and maintenance.

£80,000-100,000



53. Batmobile Designs †Δ

BATMAN (1989)

Batmobile designs from Tim Burton's superhero film *Batman*. The legendary vehicle, synonymous with the caped crusader (Michael Keaton), was created by Oscar®-winning production designer Anton Furst. Presented on a black card mount, the artwork depicts two black-and-white printed designs of the vehicle showing different jet-engine components and windscreens. Remaining in excellent condition, the board has been covered in clear plastic adhesive to protect the images.

Dimensions: 32 cm x 29 cm x 0.5 cm (12 ½" x 11 ½" x ¼")

Please note this lot is sold without copyright, reproduction rights, licensing agreements or any other type of legal releases.

£300-500

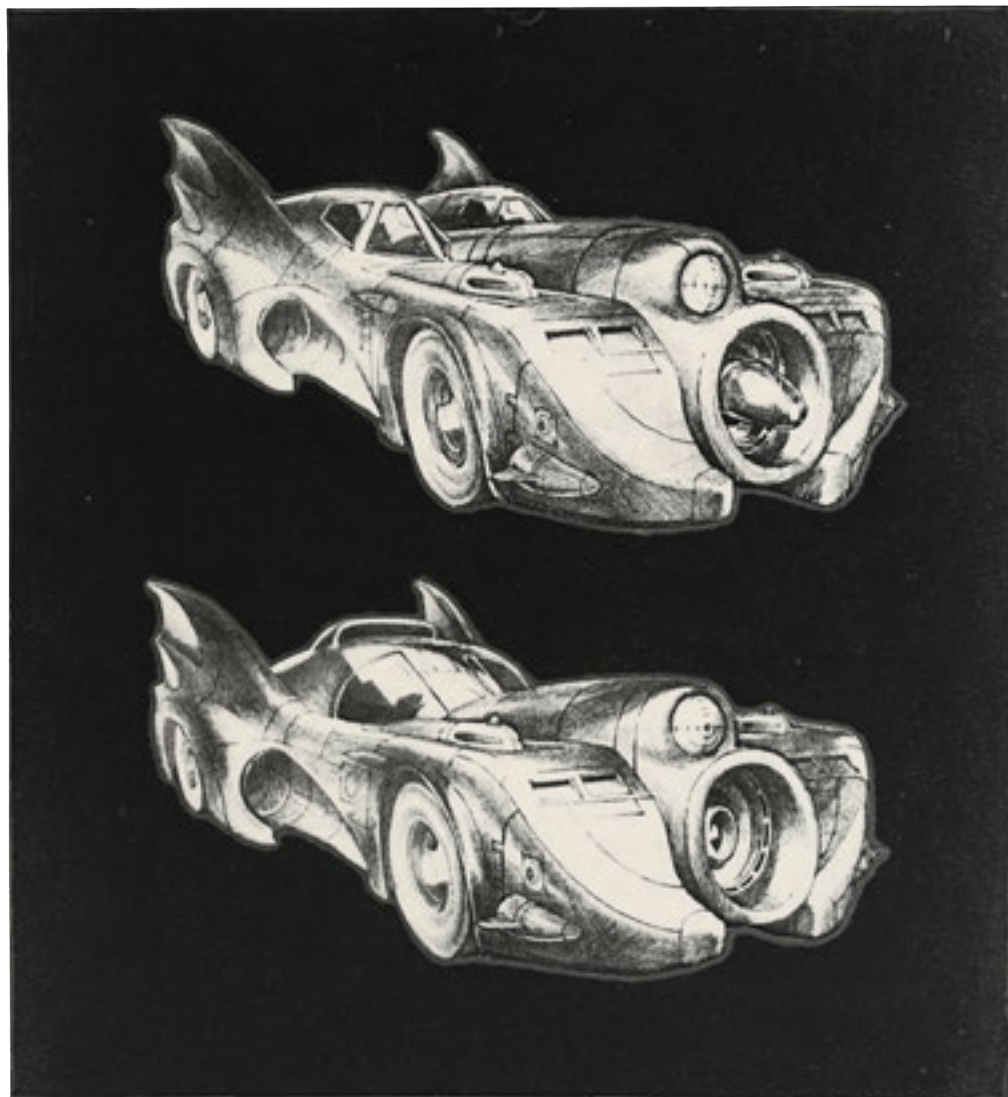

54. Set of Four Hand-Drawn Storyboards M

BATMAN (1989)

A set of hand-drawn storyboards from Tim Burton's superhero film *Batman*. The lot consists of four pages depicting various scenes, including two of Jack Napier's (Jack Nicholson) men shooting at the camera in the Axis chemicals plant, the Batmobile racing down the street, and Batman (Michael Keaton) standing on a rooftop staring up at the Bat-Signal.

Three of the pages feature the text "Batman, Pinewood — 88, 78/mw" in black on the right side. The storyboards display minor marks and wear.

Dimensions (per page): 30.5 cm x 23 cm (12" x 9")

Please note this lot is sold without copyright, reproduction rights, licensing agreements or any other type of legal releases.

£500-700

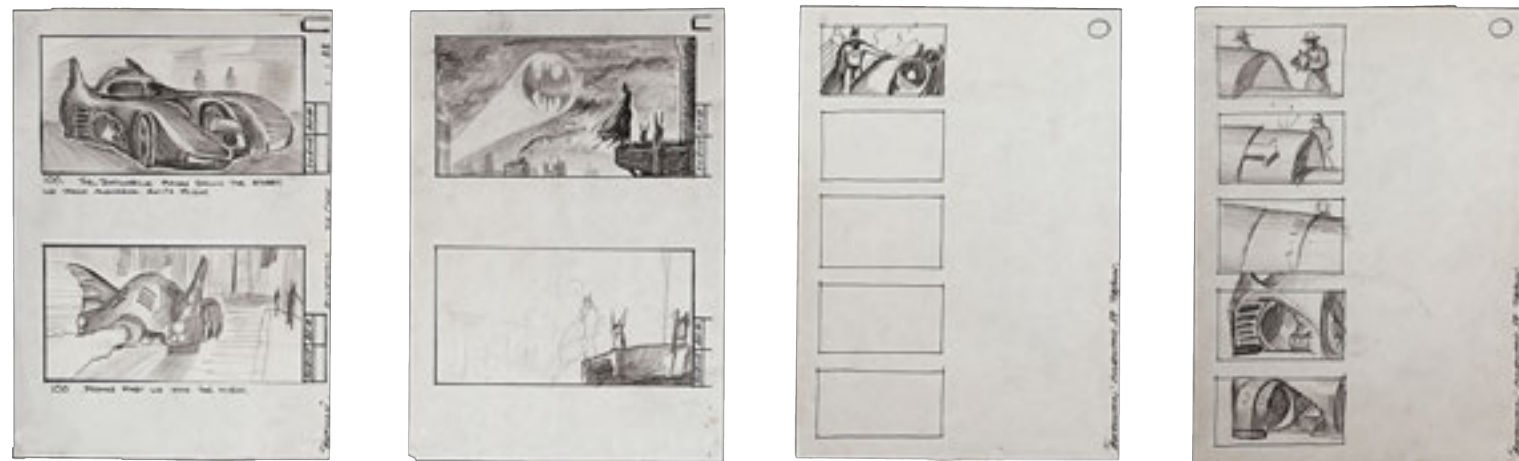

55. Gold-Painted Joker Statue Crew Gift M

BATMAN (1989)

A Joker statue crew gift from Tim Burton's superhero film *Batman*. A limited number of statues were gifted to the senior crew who worked on the production.

Made of cast resin, the figure shows the maniacal Joker (Jack Nicholson) standing proudly and holding his fedora. The statue displays defined detailing, including his suit, slicked back hair and villainous smile. Finished in faux-gold paint, the statue contains an internal metal armature which adds weight and the piece is mounted on a wooden base. The crew gift has minor paint wear on the base and on the statue, notably on the left sleeve, where the resin beneath is exposed.

Dimensions: 12.5 cm x 37 cm x 46 cm (5" x 14 ¾" x 18 ¼")

£400-600

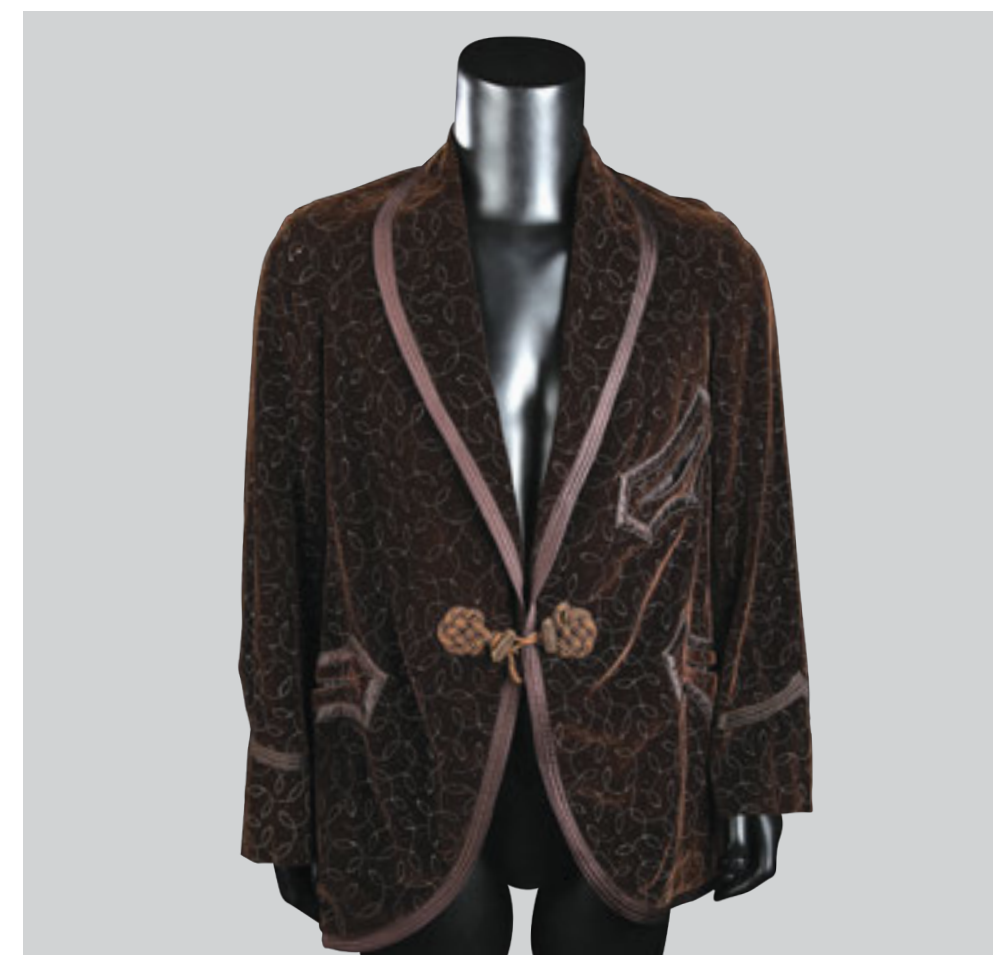

56. Tucker Cobblepot's (Paul Rubens) Smoking Jacket †Δ

BATMAN RETURNS (1992)

Tucker Cobblepot's (Paul Rubens) smoking jacket from Tim Burton's superhero sequel *Batman Returns*. The jacket screen matches to the scene in which Tucker Cobblepot and his wife Esther (Diane Salinger) watched their grotesque son Oswald abuse the family cat.

Made from dark brown velvet, the garment features a delicate pattern of tiny painted faux silver dots. Three pockets adorn the front, along with decorative woven fastenings and silk trimming. The initials "T.B.S." are written in white on the inside lining, and adhered to the left sleeve is a label reading "Warner Bros Studios". The jacket has no size marked and displays a small tear in the velvet at the back of the neckline, slight wear on the lining around the neck, and loose threads within.

£600-800

57. "SHRECK'S" Painted Gotham City Bus Bench Back US**BATMAN RETURNS (1992)**

A "SHRECK'S" painted Gotham City bus bench back from Tim Burton's superhero sequel *Batman Returns*. Bench advertisements were seen on the streets of Gotham throughout the film. A Shreck's bench is briefly seen in the background when Batman battles Penguin's (Danny DeVito) goons.

Advertising Max Shreck's (Christopher Walken) department store, this bus bench back is made of plywood with a metal frame, and displays "For All your Christmas Shopping – SHRECK'S" painted in red and white. The bench back shows surface scratches to the wood and paint due to production use and age, but remains in very fine condition.

Dimensions: 214 cm x 2 cm x 62 cm (84 ¼" x ¾" x 24 ¼")

£1,000-2,000

**58. "National Bank of Gotham" Painted Gotham City Bus Bench Back US****BATMAN RETURNS (1992)**

A "National Bank of Gotham" painted Gotham City bus bench back from Tim Burton's superhero sequel *Batman Returns*. Bench advertisements were seen on the streets of Gotham throughout the film. This particular bench is seen when Batman (Michael Keaton) uses his remote-control batarang to dispatch multiple Penguin goons.

Advertising the esteemed bank, this bus bench back is made of plywood, and displays "NBG — National Bank of Gotham" painted in yellow over a black wash. The bench back shows surface scratches to the wood, particularly around the perimeter, where a metal frame was previously attached. The bench remains in very fine condition.

Dimensions: 213 cm x 1 cm x 61 cm (84" x ½" x 24")

£1,000-2,000

**59. Penguin Head Maquette Ω****BATMAN RETURNS (1992)**

A penguin head maquette from Tim Burton's superhero sequel *Batman Returns*. The Penguin (Danny DeVito) employed an army of penguins in the sewers of Gotham, whom he outfitted with rockets to destroy the city at the end of the film. This reference head is made of dense foam, and is covered with black, white, and orange faux fur. The eyes and beak are painted black in colour, with orange detailing on the lower beak. The penguin head is supported by a metal rod that is screwed to a wood wall mount. The lot shows some wear due to production use and age, but remains in good overall condition.

Dimensions (head): 43 cm x 28 cm x 27 cm (17" x 11" x 10 ½"); (on display): 45 cm x 50 cm x 48 cm (17 ¾" x 19 ¾" x 19")

£1,500 - £2,000

**60. Selina Kyle's (Michelle Pfeiffer) Spray-Painted T-shirt †Δ****BATMAN RETURNS (1992)**

Selina Kyle's (Michelle Pfeiffer) spray-painted T-shirt from Tim Burton's superhero sequel *Batman Returns*. Selina defaced a T-shirt when she trashed her apartment and transformed into the villainous Catwoman.

The baby pink T-shirt features a printed image of two kittens, one inside a box, playing with a bunch of holly. Black spray-paint graffiti lines applied by Selina adorn the front, ruining the garment's initial charming appearance. The shirt displays signs of wear, including several intentional black marks and minor marks on the back from production use, while the colour of both the kitten image and the spray paint has faded over time.

£400-600



61. The Penguin's (Danny DeVito) Top Hat †Δ

BATMAN RETURNS (1992)

The Penguin's (Danny DeVito) top hat from Tim Burton's superhero sequel *Batman Returns*. The Penguin wore his top hat in numerous scenes as part of his 'respectable' guise as Oswald Cobblepot, mayoral candidate for Gotham.

Made from black felt and finished with a black silk hatband and bow, the hat features a cream-coloured silk lining with a chamois leather protective strip around the lower portion. "Danny DeVito" is written in black marker on a name tag at the back, beneath which is printed "Anne Gainsford at the Richmond Studio". Around the forehead area, the chamois is stained with white facial make-up, used to transform DeVito into the enigmatic villain.

The Penguin's top hat is presented on a black custom display stand. It shows light wear on the exterior, in addition to the make-up residue on the inner lining from production use.

Dimensions (displayed): 31cm x 31cm x 43cm (17" x 12 ¼" x 12 ¼")

£4,000-6,000

62. Catwoman (Michelle Pfeiffer) Prototype Make-Up Test Bust †Δ

BATMAN RETURNS (1992)

A make-up test bust of Catwoman (Michelle Pfeiffer), made for Tim Burton's superhero sequel *Batman Returns*. Paint busts are used by make-up artists to test the effects of make-up and develop aesthetic concepts, ensuring accuracy and saving time on set. The film was nominated for several awards, including a Saturn Award, for its costume designs.

Inspired by a German sculpture of a patchwork-like woman's head and shoulders, this lifelike clay bust was sculpted by Jose Fernandez and painted by costume designer Bob Ringwood for the approval of the director. This concept was

approved. The white-painted facial area features bright red lip colouring and darkened eye sockets. This bust is presented on a custom-made black wood display. Minor paint cracks and wear show on the cowl from production use, with further holes and marks around the base. The right ear shows signs of repair.

Dimensions: 32 cm x 61 cm x 42 cm (12 ½" x 24" x 16 ½")

£3,000-5,000



63. Catwoman's (Michelle Pfeiffer) Corset †Δ

BATMAN RETURNS (1992)

Catwoman's (Michelle Pfeiffer) corset from Tim Burton's superhero sequel *Batman Returns*. Catwoman wore her black latex corset throughout the film as she sought revenge for the wrongs committed against her. *Batman Returns'* costume design team was nominated for a Saturn Award for its work on the film.

With a strong fabric frame, the corset is covered in large white angled stitches, contributing to the handmade look costume designers Bob Ringwood and Mary Vogt intended. The laces are stained with red, green, white and orange paint and make-up, and there is extensive distressing to the rest of the costume, as a result of the climactic sewer battle with Max Shreck (Christopher Walken). Black stitching emphasises the shape of the wearer. The back is fastened with black cotton laces passed through 20 eyelets.

The corset features "M. Pfeiffer (sic), Stage 3, No. 4" handwritten on a tag, indicating the level of distressing applied, how far into the film it was to be used, and that this was one of several outfits created for production.

Catwoman's corset is presented on a black wooden custom display stand. It displays intentional distressing and wear from production, including red, green, white and orange paint and make-up residue.

Dimensions: 50 cm x 30 cm x 23 cm (19 3/4" x 12" x 9")

£3,000-5,000



64. Catwoman's (Michelle Pfeiffer) Boots †Δ

64. Catwoman's (Michelle Pfeiffer) Boots †Δ

BATMAN RETURNS (1992)

Catwoman's (Michelle Pfeiffer) boots from Tim Burton's superhero sequel *Batman Returns*. Catwoman wore her trademark stiletto boots throughout the film, which was nominated for several awards, including a Saturn Award for its costume design.

Inspired by a sewn-together German sculpture, costume designer Bob Ringwood modernised Bob Kane's classic Batman villain with a striking, handmade suit. These knee-high black leather boots feature high stiletto heels, pointed toes, high soles and subtle stitching. The laces fasten in a criss-cross pattern through 29 eyelets, and are tied at the top. Each toe features V-shaped detail, while the heel portions comprise curved leather pieces.

Catwoman's boots are presented on a custom-made display. They show creases and scuffs from production use, especially around the heels, toes and soles.

Dimensions (displayed): 49 cm x 24 cm x 20 cm (19 1/4" x 9 1/2" x 8")

£2,000-3,000

BATMAN RETURNS (1992)

Catwoman's (Michelle Pfeiffer) metal-clawed glove from Tim Burton's superhero sequel *Batman Returns*. Part of her feline-influenced arsenal, the femme fatale wore her signature claws throughout the film, with metal claws used for the special effects shots in which she had to physically scratch into surfaces.

Made from black pleather, the long evening glove features five metal claws, which are finished in black paint and sewn onto each fingertip. Each claw is a unique creation fashioned from thimbles, razors, wires and other sharp sewing implements. The glossy, latex coating has deteriorated since production and is now nearly completely stripped off the glove. Displayed on a custom-made stand, signs of age are evident, including paint chips and a coating of surface corrosion over each claw.

Dimensions (displayed): 13 cm x 13 cm x 43 cm (5" x 5" x 17")

£1,500-2,000



66. Bat-Vehicle Model Miniature Components and Penguin Rockets Ω

BATMAN RETURNS (1992)

Bat-vehicle model miniature components and three penguin rockets from Tim Burton's superhero sequel *Batman Returns*. This lot consists of the FX flame cannon from various Bat-vehicles, a landing foot for the Batskiboat and a set of three Penguin rockets from the climax of the film.

The flame cannon was outfitted on the back of the Batmobile and the Batskiboat model miniatures, and was used to project controlled fire. The Batskiboat landing foot was never used on screen, though it was seen on officially licenced toys. Also included are a full-size dense foam rocket, and two smaller-scale practical metal rockets from the Batskiboat sewer sequence.

The largest rocket shows a small break in one of the stabilizer fins, and the smallest rocket is missing one stabilizer fin. The lot remains in fine condition.

Dimensions (flame cannon): 15 cm x 15 cm x 16 cm (5 ¾" x 5 ¾" x 6 ¼"); (landing foot): 42 cm x 4.5 cm x 20 cm (16 ½" x 1 ¾" x 7 ¾"); (largest rocket): 32 cm x 7 cm x 7 cm (12 ½" x 2 ¾" x 2 ¾")

£800-1,000



67. Full-Scale Batman Statue †

BATMAN FOREVER (1995)

A full-scale, limited-edition, licenced replica Batman statue sold during the release of Joel Schumacher's superhero sequel *Batman Forever*. Dressed in the muscular Bat-Suit, the caped crusader here features the likeness of actor Val Kilmer behind the mask.

The statue is made of fibreglass and resin with a metal-rod internal support. The Bat-Suit is painted metallic blue, and the black polyester cape's hem incorporates rods to ensure it hangs correctly and is distressed to look well used. The statue is presented on a wood and fibreglass base that's painted grey and supported by metal rods via the feet.

Dimensions: 50 cm x 90 cm x 205 cm (19 ¾" x 35 ½" 80 ¾")

£500-1,000

68. The Joker's (Heath Ledger) Stunt Sub-Machine Gun M

THE DARK KNIGHT (2008)

The Joker's (Heath Ledger) stunt sub-machine gun from Christopher Nolan's Academy Award®-winning action film *The Dark Knight*. The Joker used his weapon as he emerged from the flipped truck after he and his henchmen attacked the convoy containing Harvey Dent (Aaron Eckhart).

This stunt version of a Smith & Wesson M76 sub-machine gun is made from dense foam rubber, and displays detail including an engraved Smith & Wesson serial number and logo and metal hooks cast into the barrel. The gun displays signs of wear from use, including light scratches, chips to the plating on the metal hooks and exposed foam rubber at the end of the barrel. Dimensions: 51 cm x 26 cm x 6 cm (20" x 10 ¼" x 2 ¼")

Please note, ownership of this item is restricted for U.K. residents to registered re-enactors, galleries, or individuals in film, television or theatre production. Please enquire for further details. It is solely the buyer's responsibility to check, prior to bidding, the legal status of this prop within their own country and the importation therein.

£4,000-6,000



69. Heath Ledger Autographed Scorched Joker Card M

THE DARK KNIGHT (2008)

An autographed scorched Joker card from Christopher Nolan's Academy Award®-winning action film *The Dark Knight*. Cards were used by the psychotic Joker (Heath Ledger) throughout the film as he wreaked havoc on Gotham City, planting cards in a car bomb that killed Gotham judge Janet Surillo (Nydia Rodriguez Terracina).

Made of card, the piece features a black jester head with the word "Joker" printed underneath. The jester's face has burnt away and the card has a scorched appearance due to being used on set at Battersea Power Station, where the explosion scene was filmed. The card was autographed on set by Heath Ledger using black marker and was gifted to a crew member. Ledger sadly passed away before the release of the film in 2008, making this card one of few pieces from the production signed by the actor. Damaged from use, the lot displays minor scratches, crease lines and burn marks.

Dimensions: 9 cm x 6 cm (3 ¾" x 2 ¾")

£600-800



70. Mike Zeck Hand-Drawn Batman Pin-up Ω

BATMAN / DETECTIVE COMICS #600 (1989)

A hand-drawn Batman pin-up by Mike Zeck for a special tribute gallery within Detective Comics #600. Celebrating the 50th anniversary of the Caped Crusader, Detective Comics #600 included a gallery of pin-up artwork at the back of the issue, featuring Batman art by acclaimed artists such as Bernie Wrightson, Neal Adams, Walt Simonson, Keith Giffen and Al Gordon, among others.

This Batman pin-up was drawn soon after Zeck's famous run of covers that he drew for the classic "Ten Nights of the Beast" storyline that appeared in Batman #417-420.

This original pencilled-and-inked pin-up is drawn on Bristol board by renowned artist Mike Zeck (Captain America, The Punisher, Spider-Man). The artwork shows Batman gliding above Gotham City with his Batrope. The back of the sheet shows

two DC Comics stamps and Mike Zeck's name. This art was featured in an exhibit of Mike Zeck's art titled "Dynamic Lines" at the University of Maryland Eastern Shore in 2015 and was used as the poster art for the exhibit.

Included with the lot is a reference copy of Detective Comics #600, the comic book in which this art was originally published, along with a copy of the promotional postcard from the Dynamic Lines exhibit. The artwork is in very good condition. Dimensions: 42 cm x 28 cm (16 1/2" x 11")

Please note this lot is sold without copyright, reproduction rights, licencing agreements or any other type of legal release.

£4,500-6,000



71. Cylon Raider Model Miniature Ω

BATTLESTAR GALACTICA (TV SERIES, 1978 - 1979)

A Cylon Raider miniature from the classic sci-fi television series *Battlestar Galactica*. Cylon Raiders were the primary Starfighter used by the Cylons throughout the series. This production-used miniature was supplied by the Monogram model company, which had pantographed miniatures from the series in order to mass produce commercial models.

Made of styrene plastic, the piece resembles a futuristic flying saucer and is expertly painted by the production. The Cylon Raider shows some wear due to production use but remains in very fine condition.

Dimensions: 23 cm x 27 cm x 6 cm (9" x 10 3/4" x 2 1/2")

This model kit version was sent by Monogram to the visual-effects house working on the series. The Monogram kits were used for forced perspective shots with the studio-scale Cylon Raiders, and for use as background models in a hangar shot.

£6,000-8,000

72. Number Six's (Tricia Helfer) Red Dress M

BATTLESTAR GALACTICA (TV MINISERIES 2003)

Number Six's (Tricia Helfer) red dress from the sci-fi miniseries *Battlestar Galactica*. Appearing to Dr. Gaius Baltar (James Callis) in a hallucinatory form, Six wore her distinctive dress while attempting to manipulate him to pursue her own agenda.

Custom-made for the miniseries, the sleeveless and almost backless outfit is constructed from a red Lycra blend. Following the success of the two-part pilot, the costume designers decided to change the red material for the subsequent series that followed. Completing the costume is a pair of black stiletto sandals with clear plastic studded straps and adhered labels reading "#6 No Six 401, 402" on each sole. The outfit is also accompanied by a studio certificate of authenticity and an autographed promotional still, signed and dedicated by Helfer in silver ink. The costume remains in excellent condition.

£6,000-8,000



74. Hero Colonial Sidearm M

BATTLESTAR GALACTICA (TV SERIES, 2004 - 2009)

A hero Colonial sidearm from the sci-fi television series *Battlestar Galactica*. Introduced during the second season, the modified FN-57s were carried by the surviving members of the Colonial Military throughout the remainder of the series. The earlier miniseries had the actors using the Clamshell-style revolver that inevitably became too cumbersome, resulting in the need for a more user-friendly design.

The FN Herstal Five-sevenN pistol is finished in black and features an under-barrel explosive launcher and brown grip painted to resemble wood. It has been sympathetically deactivated with the slides, magazine release and trigger still functional, and is accompanied by a current UK deactivation certificate. Well-used, the firearm shows evidence of production wear, including scratches and paint chips on the grip.

Dimensions: 22 cm x 14 cm x 5 cm (8 3/4" x 5 1/2" x 2")

This weapon has been permanently and sympathetically deactivated to UK legal requirements (at the time of deactivation) and no longer retains any functional capacity to fire. It is accompanied by a proof house certificate of deactivation. The weapon may require further deactivation and re-certification prior to shipping at the buyers expense, based upon current legislation, buyer and weapon location. It is solely the buyer's responsibility to check, prior to bidding, the legal status of this weapon within their own country and the importation thereof.

£3,000-5,000

73. William Adama's (Edward James Olmos) Duty Blues Costume M

BATTLESTAR GALACTICA (TV SERIES, 2004 - 2009)

William Adama's (Edward James Olmos) duty blues from the sci-fi television series *Battlestar Galactica*. The Admiral wore his duty blues throughout the series as he commanded the crew aboard the *Galactica*.

Made from synthetic blue material, the duty uniform consists of a jacket with suede shoulders and red-and-tan piping; trousers with V-opening leg cuffs; and a belt with plastic buckles finished in faux-gold paint. The jacket features an embroidered "Battlestar Galactica BSG 75" patch sewn to the left arm, two Admiral-rank collar pips and a Senior Pilot pin secured to the left breast. Handwritten labels, reading "Adama", are pinned inside the jacket and on the belt buckle. Designed to be tucked in during production, the bottom of the jacket remains open, with minor fraying threads. The outfit is accompanied by a studio certificate of authenticity.

£4,000-6,000



75. Apollo's (Jamie Bamber) Viper Pilot Spacesuit M

BATTLESTAR GALACTICA (TV SERIES, 2004 - 2009)

Apollo's (Jamie Bamber) Viper pilot spacesuit from sci-fi television series *Battlestar Galactica*. Lee "Apollo" Adama wore his suit during the episode "Resurrection Ship", ejecting from the Blackbird and floating through space after preventing the Cylon resurrection ship's escape.

Made from a thick synthetic fabric, the metallic-green flightsuit includes a pair of black gloves and vest decorated on the back with protective plates. A utility belt is fitted at the waist. The flightsuit features two Major rank pins, a Junior Flight pin and embroidered "Viper", "Galactica" and "Vigilantes 3" patches on the arms and chest. Adhered to the left leg in a clear vinyl sleeve is a Viper "Pre-Flight Check List", and the pockets are filled with plastic components. Inside the vest, handwritten in white marker, is "Apollo M-Long #2", while each glove has labels reading "Bamber". The suit has a cut in the back to allow access for a harness.

Completing the costume is a helmet and collar. The functional, light-up helmet displays a silver-coloured paint finish with a clear plastic visor. It connects to power packs housed inside the suit's utility belt that illuminate its interior lights and circulate air to prevent the helmet fogging up. Handwritten "Seelix" and faded "Adama" labels are taped to the helmet's foam lining.

Presented on a custom-made display, the flightsuit and helmet include studio certificates of authenticity and the original helmet storage bag. Showing signs of wear from age and production use, the costume displays cracks and tears in the metallic-coloured fabric, and the helmet paint is worn and scratched.

Dimensions (displayed): 34 cm x 64 cm x 205 cm (13 1/2" x 25" x 81")

This item contains electronic components. While every effort has been made to describe them accurately, no guarantee or warranty is made as to the functionality, lifespan or safety of those components. It is entirely incumbent on the new owner to satisfy themselves as to their safe use and maintenance.

£6,000-8,000



76. Alicia Nash's (Jennifer Connelly) Refractive Glass Gift Ω

A BEAUTIFUL MIND (2001)

Alicia Nash's (Jennifer Connelly) refractive glass gift from Ron Howard's Oscar®-winning drama *A Beautiful Mind*. John Nash (Russell Crowe) gave Alicia a gift of refractive glass after arriving at her birthday dinner late.

This piece is made of glass and features many angled faces. This design allows the glass to produce every possible color when held to a light source. The piece shows minimal signs of wear and is in very fine condition.

Dimensions: 5 cm x 5 cm x 5 cm (2" x 2" x 2")

£1,000-1,500



77. Walter Black's (Mel Gibson) Beaver Puppet with Information Card Ω

THE BEAVER (2011)

Walter Black's (Mel Gibson) beaver puppet from Jodie Foster's comedy-drama *The Beaver*. Walter Black suffered from depression and used a beaver puppet as a method of coping with his mental illness.

This plush beaver puppet has an opening at its bottom which allows the user to insert their arm and manipulate the mouth. The piece is detailed with plastic eyes, a plastic nose and a set of urethane teeth. A wire lines the perimeter of the tail, allowing it to be manipulated and set to a specific position. The interior of the puppet is lined with spandex, and marked "#5".

Also included with the puppet is Walter's information card, given to him by his psychiatrist in order to explain his use of the puppet to the general public. A custom-made stand accompanies the piece for display purposes. Intentional wear is present throughout the puppet and it is in very fine overall condition. Dimensions (on stand): 28 cm x 23 cm x 48 cm (11" x 9" x 19")

£800-1,200

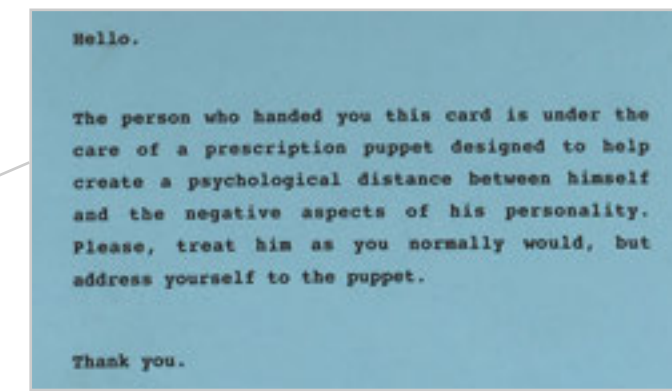

Hello.

The person who handed you this card is under the care of a prescription puppet designed to help create a psychological distance between himself and the negative aspects of his personality. Please, treat him as you normally would, but address yourself to the puppet.

Thank you.



78. Sandworm Puppet Ω

BEETLEJUICE (1988)

A sandworm puppet from Tim Burton's horror comedy *Beetlejuice*. This puppet was made by the production for stop-motion sequences featuring the creature that eventually devoured Beetlejuice (Michael Keaton). This version is missing its back fin and varies slightly from the one seen on screen.

The piece is made of foam-filled latex and with a supportive armature at its core. Painted black and white with bright green details, the puppet is displayed on a wood and Styrofoam base painted to resemble the sand that the creature dwells in. The puppet shows cracking to the skin from age and is in overall fine condition.

Dimensions: 33 cm x 17 cm x 41 cm (13" x 6 ½" x 16")

£3,000-4,000



79. Bill (Alex Winter) Miniature Puppet Ω

BILL & TED'S EXCELLENT ADVENTURE (1989)

A Bill (Alex Winter) miniature puppet from Stephen Herek's time-travel comedy *Bill & Ted's Excellent Adventure*. About to fail their high-school history class, wannabe rock stars Bill and Ted (Keanu Reeves) were given the opportunity of a lifetime when a mysterious man from the future loaned the duo a time machine, in the form of a telephone booth. Puppets were used in a model miniature of the telephone booth for FX shots in which the time machine vanishes into the ground.

This Bill puppet is made of dense foam and wood, and is dressed in fabric that resembles the actor's costume, with a purple sweater, white T-shirt, blue jeans and sneakers. The puppet shows some wear due to production use, with the sides of the head showing glue residue. The lot remains in fine condition.

Dimensions: 13 cm x 6 cm x 34 cm (5" x 2 ½" x 13 ½")

£2,000-3,000



80. Socrates (Tony Steedman) Miniature Puppet Ω

BILL & TED'S EXCELLENT ADVENTURE (1989)

A Socrates (Tony Steedman) miniature puppet from Stephen Herek's time-travel comedy *Bill & Ted's Excellent Adventure*. About to fail their high-school history class, wannabe rock stars Bill (Alex Winter) and Ted (Keanu Reeves) were given the opportunity of a lifetime when a mysterious man from the future loaned the duo a time machine, in the form of a telephone booth. Puppets were used in a model miniature of the telephone booth for FX shots in which the time machine vanishes into the ground.

This Socrates puppet is made of plaster and wood, and is dressed in a silk robe with decorative embroidery that resembles the actor's costume. The puppet shows some wear due to production use, with breaks to the plaster skin, and it is missing its hands and feet. The lot remains in fair condition.

Dimensions: 13 cm x 6 cm x 38 cm (5" x 2 ½" x 15")

£2,000-3,000



81. Baldrick's (Tony Robinson) Bridesmaid Dress M

BLACKADDER II (TV SERIES 1986)

Baldrick's (Tony Robinson) bridesmaid dress from the BBC period sitcom *Blackadder II*. Baldrick wore his dress at the wedding service of Lord Blackadder (Rowan Atkinson) and "Bob" (Gabrielle Glaister) in the first episode, titled "Bells".

Made from a blue brocade, the Elizabethan-style dress features a floral-and-bird embroidered pattern all over. Heavily decorated with faux-gold trim, pearl-like beads and small bows, the front of the bodice contains internal boning, while hook-and-eye fastenings run down the back. The pleated skirt is open at the front with matching enhancing trim, and pearl beads and fastenings are adhered to the skirt, allowing it to be firmly attached to the bodice. A label reading "Tony Robinson" is adhered to the inside of the bodice and the dress displays loose threads, minor wear to the bows and discolouration to the lining.

£1,500-2,500



82. Blade's (Wesley Snipes) Costume M

BLADE (1998)

Blade's (Wesley Snipes) costume from Stephen Norrington's action horror *Blade*. The half-vampire wore his black leather trench coat, tactical vest, trousers and T-shirt throughout the film. This is one of several costumes created for scenes including the subway fight, when Blade took on Quinn (Donal Logue) while protecting Karen (N'Bushe Wright) from the vampire horde.

Blade's full-length faux-leather trench coat was an essential element of his iconic appearance. It features a triangular hole between the shoulder blades for his sword and fastens at the waist with a black belt and heavy metal buckle.

Custom-made for the film, the faux-leather tactical vest features rubber padding and numerous storage pockets. Two strong non-adjustable metal buckles clip across the chest, with a further two at the shoulders, while a rotatable sword holster is attached at the middle of the backpiece. Inside, faded writing reads "Wesley Snipes #4, Subway Ext 12".

Blade's nylon Armani Exchange trousers feature thick inner padding. The initials "WS" are handwritten on the label. A long black Jasper Conran belt fastens around the waist with a silver-coloured buckle. The black cotton Banana Republic T-shirt (size L) features a ribbed design with short 'muscle' sleeves. The initials "WS" are handwritten on the label.

Each piece exhibits production-based wear, including mud and bloodstains on the trench coat and trousers, and a sticky residue on the trousers. On the tactical vest, the sword holster has partly come away from its mount, indicating heavy production use.

Dimensions: 28 cm x 50 cm x 143 cm (11" x 19 ¾" x 56")

£10,000-15,000



83. Blade's (Wesley Snipes) Aluminium Stakes and Poster M**BLADE (1998)**

A set of three aluminium stakes and a promotional poster from Stephen Norrington's vampire action-thriller *Blade*. Blade (Wesley Snipes) wore metal stakes in a bandolier around his left thigh throughout the movie, notably pinning Quinn (Donal Logue) to a wall with two, before setting him alight.

Each stake features a machined groove around the base and sits inside a nylon and Kevlar® bandolier, which has three leather loops with riveted metal plates to hold the weapons. There is an adjustable ratchet strap to clip around the leg, with a support strap extending from the top for fastening to a belt. The stakes and metal plates feature scratching and light corrosion, but remain in good overall condition. Accompanying the stakes is a 27" x 40" promotional poster printed on thick card, which is in very good condition.

Dimensions (stakes and bandolier): 66 cm x 45 cm x 4 cm (26" x 17 ¾" x 1 ½")

£1,000-1,500

84. Blade's (Wesley Snipes) Set of EDTA Darts M**BLADE (1998)**

Blade's (Wesley Snipes) set of EDTA darts and bandolier from Stephen Norrington's vampire action-thriller *Blade*. Blade wore his EDTA darts on an arm bandolier while infiltrating Deacon Frost's (Stephen Dorff) hideout. Their anticoagulant acid exploded on contact with vampire blood. Blade injected Frost with multiple EDTA doses during their climactic battle.

The set comprises five darts held on a flexible nylon webbing band, which features eight black leather loops with hard plastic supports and tip protectors. Three loops are empty, with the tip missing from one. Each dart consists of a brushed metal canister containing blue fluid within a glass tube. Metal hook clips at each end enable the bandolier to be worn around the upper arm. The piece shows dirt, and scratches are present on each side from use. One test tube is missing from its metal canister.

Dimensions: 44 cm x 15 cm x 2.5 cm (17 ¼" x 6" x 1")

£2,000-3,000

**85. Blade's (Wesley Snipes) Daywalker Sword M****BLADE (1998)**

Blade's (Wesley Snipes) Daywalker sword from Stephen Norrington's action horror *Blade*. The half-human, half-vampire carried his sword in multiple scenes throughout the film and wielded it as he battled Deacon Frost (Stephen Dorff) after he'd become the avatar of the supreme blood god La Magra.

The weapon was created by sword maker Tony Swatton and displays a thin, polished aluminium blade with fuller detailing running down its length. Finished in black and faux-silver paint, the round grip is flat on one side and is decorated with ornate vampiric glyphs and ribbed detailing. Signs of wear from production use are present on the weapon, including paint wear on the handle, minor scratches and marks on the blade.

Dimensions: 89 cm x 5 cm x 4.5 cm (35" x 2" x 1 ¾")

£3,000-5,000

**86. Light-up UV Bomb M****BLADE II (2002)**

A light-up UV bomb from Guillermo del Toro's vampire action-thriller sequel *Blade II*. Ultraviolet bombs were tested and shown to Blade (Wesley Snipes) by Scud (Norman Reedus) and Whistler (Kris Kristofferson), and used when they battled the Reapers in the sewers of Prague.

Crafted from resin, the bomb displays a geometric design, with coil-like detailing in copper-coloured paint. Finished in dark grey and faux silver, it displays circular blue acrylic pieces with blue LED lights underneath. The lights illuminate when an accompanying metal pin is inserted into the top. The bomb shows minor paint wear and chips from production use and the lot is accompanied by a New Line Cinema letter of authenticity.

Dimensions: 11 cm x 7 cm x 7 cm (3 ½" x 2 ¾" x 2 ¾")

This display contains electronic components. While every effort is made to describe them accurately, no guarantee or warranty is made as to functionality, lifespan or safety of those components. It is entirely incumbent on the new owner to satisfy themselves as to their safe use and maintenance.

£800-1,200



87. Blade's (Wesley Snipes) Glaives M

BLADE II (2002)

A pair of Blade's (Wesley Snipes) glaives from Guillermo del Toro's vampire action-thriller sequel *Blade II*. The Daywalker notably used his glaives at the beginning of the film as he chased a group of vampires in the Czech Republic and finds the location of the imprisoned Whistler (Kris Kristofferson).

The lot comprises a hero and stunt version of the weapon, with both displaying two curved blades with partly serrated edges and a central emblem. The hero version is made from polished metal and contains a locking mechanism which, when pressed, allows one of the blades to be folded inwards. The stunt glaive is made of rubber, finished in faux silver to replicate the appearance of metal. The lot displays cracks in the paint, scratches and minor paint wear. The rubber glaive is accompanied by a New Line Cinema letter of authenticity.

Dimensions (both versions): 24 cm x 18 cm x 3 cm (9 1/2" x 7 1/4" x 1 1/4")

£2,000-3,000

88. Truce Key M

BLADE II (2002)

A truce key from Guillermo del Toro's vampire action-thriller sequel *Blade II*. Blade (Wesley Snipes) received a key from Overlord Eli Damaskinos (Thomas Kretschmann) requesting a truce and inviting him to lead the Bloodpack against the mutated vampire Reapers.

Made from cast resin, the key consists of a circular base with a central tube section and a round top piece. Finished in silver paint, the top and bottom sections of the piece display engraved vampiric glyphs. A ribbed indentation wraps around the middle section and the decorative features on the key are highlighted in red. The truce key displays minor paint wear and scuff marks, notably on the base section. The lot is accompanied by a New Line Cinema letter of authenticity. Dimensions: 20.5 cm x 7 cm x 7 cm (8 1/4" x 2 3/4" x 2 3/4")

£1,000-1,500



89. Whistler's (Kris Kristofferson) Costume M

BLADE II (2002)

Whistler's (Kris Kristofferson) costume from Guillermo del Toro's vampire action-thriller sequel *Blade II*. Whistler wore his costume in multiple scenes throughout the film after Blade (Wesley Snipes) rescued him from a group of vampires.

The costume consists of a grey textured long-sleeved top with a button opening, a black net vest, a leather vest and leather jacket. Marked as a size medium, the vest features two pockets on the front and popper fastenings. A zip fastening runs down the front of the Roots leather jacket and an embossed emblem adorns the right sleeve. The costume displays minor wear from production use and is accompanied by a still of Whistler signed by Kristofferson.

Dimensions (still): 20 cm x 25 cm (8" x 10")

£800-1,200



90. Blade's (Wesley Snipes) Stunt MAC-11 Pistol and Holster M

BLADE II (2002)

Blade's (Wesley Snipes) stunt MAC-11 submachine gun and holster from Guillermo del Toro's vampire action-thriller sequel *Blade II*. Blade held his signature weapon from *Blade* near the beginning of the film, during a flashback scene in which he contemplated the fate of his fellow vampire hunter Whistler (Kris Kristofferson).

Cast from one of the hero weapons used on the production, the submachine gun is made of dense rubber and consists of a standard MAC-11 body with a large suppressor and frame at the front. Finished in black, it features a detailed grip, a cocking handle on the top of the body and a static trigger. The holster is made from black reinforced cotton with a Velcro strip on the back, a utility leg strap with a plastic clip fastening on one side, and a circular metal magnet to help secure it to the costume. The lot shows paint wear, marks on the holster and scratches on the magnet. Dimensions (in holster): 5 cm x 14 cm x 40 cm (2" x 5 1/2" x 15 3/4")

Ownership of this item is restricted for U.K. residents to registered re-enactors, galleries, or individuals in film, television or theatre production. Please enquire for further details. It is solely the buyer's responsibility to check, prior to bidding, the legal status of this prop within their own country and its importation therein.

£2,000-3,000



91. Hannibal King's (Ryan Reynolds) Final Costume M

BLADE: TRINITY (2004)

Hannibal King's (Ryan Reynolds) final costume from David S. Goyer's action-horror sequel *Blade: Trinity*. The ex-vampire wore his costume towards the end of the film when he battled Jarko Grimwood (Paul Levesque) and Danica Talos (Parker Posey).

The costume consists of a white ribbed cotton vest, a pair of brown cargo trousers and a black nylon duty belt with two plastic holsters attached. A bull skull emblem finished in cream and faux silver adorns the front of the belt, and a ball chain with a metal Stanley Guess pendant is suspended from a front belt loop. Both holsters display minor wear from production use and the lot is accompanied by a New Line Cinema letter of authenticity.

£600-800



92. Drake's (Dominic Purcell) Hero Sword M

BLADE: TRINITY (2004)

Drake's (Dominic Purcell) hero sword from David S. Goyer's vampire action-thriller sequel *Blade: Trinity*. The patriarch of the vampire species used his sword during the film's climatic scenes as he battled the Daywalker, Blade (Wesley Snipes).

The sword comprises a polished metal blade, with cast-in line detailing and faux-gold paint applied to the lower section. Inscribed ancient vampiric hieroglyphs run down both sides of the blade and have been incorporated onto the pommel. Finished in shades of cream paint, the bone-shaped pommel has been intentionally

distressed to replicate a worked ivory appearance and brown leather cord has been wrapped around the grip, with segments of bone peeking out of the gaps. The weapon displays surface scratches, minor damage on the edges of the blade and paint wear from use on production.

Dimensions: 100 cm x 9 cm x 5 cm (39 1/2" x 3 1/2" x 2")

£3,000-5,000



93. Drake's (Dominic Purcell) Transformation Costume Display M

BLADE: TRINITY (2004)

Drake's (Dominic Purcell) transformation costume from David S. Goyer's action-horror sequel *Blade: Trinity*. The patriarch of the vampires transformed into a demonic creature as he battled Blade (Wesley Snipes) during the final scenes of the film.

The costume consists of several prosthetic foam-latex components which are airbrushed in varying shades, and a pair of black leather trousers. The prosthetics create a muscular physique for the powerful character, with incorporated spike and vein detailing. Strips of Velcro and a zip are present as fastenings, and a strap runs between the legs to stop the torso from moving during filming. Minor paint wear and damage is present to some parts of the foam latex. The costume is presented on a custom-made display, with a base which features the film's title artwork and contains internal lights powered by a 240-volt plug.

Dimensions: 218 cm x 79 cm x 29 cm (86" x 31 1/4" x 11 1/2")

As this item contains electronic components, every effort has been made to describe them accurately. However, no guarantee or warranty is made as to the functionality, lifespan or safety of those components. It is entirely incumbent on the new owner to satisfy themselves as to their safe use and maintenance.

£4,000-6,000



94. BAFTA Certificate of Nomination M

BLADE RUNNER (1982)

A BAFTA Certificate of Nomination for Ridley Scott's iconic sci-fi thriller *Blade Runner*. The film received a BAFTA nomination for Best Sound (Peter Pennell, Bud Alper, Graham V. Hartstone and Gerry Humphreys), as well as 17 other BAFTA nominations.

The varnished wooden plaque features a light yellow centre with a wooden trim and gold-coloured borders. The distinctive BAFTA logo appears at the top of the certificate, with the nominees' names printed beneath. The signatures of the BAFTA Committee Chairman and Director appear at the bottom. The certificate displays minor marking near the centre. The number 198570U is handwritten across the back, where a hanging bracket is attached.

Dimensions: 42 cm x 33 cm x 1.5 cm (16 1/2" x 13" x 1/2")

£2,000-3,000



95. Los Angeles Skyline Miniature Components Ω

BLADE RUNNER (1982)

A set of Los Angeles model miniature skyline components from Ridley Scott's sci-fi thriller *Blade Runner*. Miniatures were used to build large Los Angeles cityscapes and create the detailed 'Hades Landscape' seen during the opening sequence. Building decals and lift grills were situated on the side of the Tyrell Corporation pyramid and formed part of the intricate miniature model of the building. Cityscape pieces were used for miniature Spinner sequences and formed part of a large, interchangeable set, lined horizontally to create the intimidating LA skyline.

The set includes eight cityscape pieces, three lift grills and a single building decal. Each component is made of etched brass, with the front of the skyline pieces finished in black, and the back displaying a bare metal finish. Holes are cut into each component to allow light to shine through. The collection displays light signs of wear, with small scratches on the black finish and slight bends in the brass.

Dimensions (largest): 40 cm x 7.5 cm (15 3/4" x 3")

£2,000-3,000

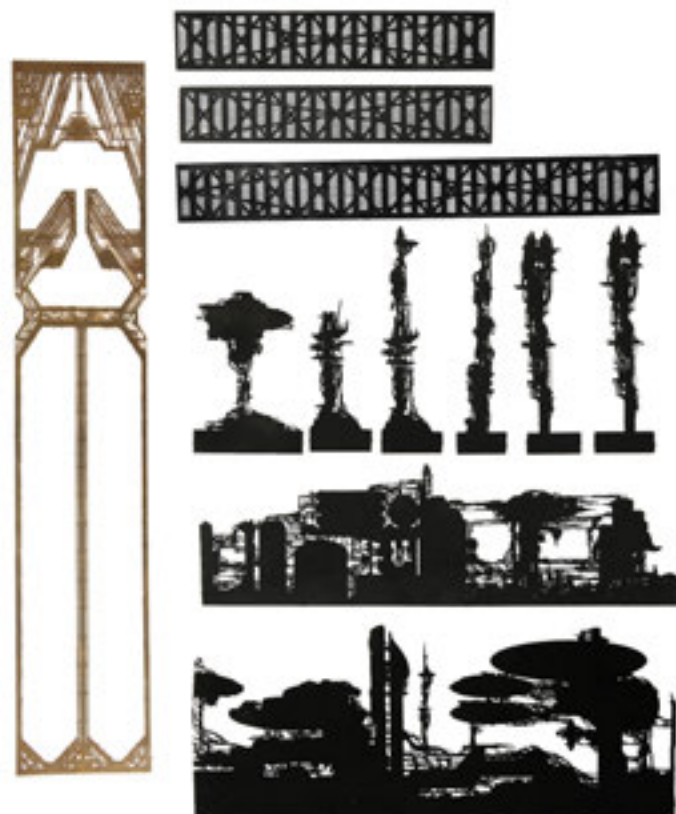

96. Tyrell Corporation Elevator Model Miniature Ω

BLADE RUNNER (1982)

A Tyrell Corporation elevator model miniature from Ridley Scott's sci-fi classic *Blade Runner*. Elevators operated on the exterior of the Tyrell Corporation building in Los Angeles.

The rectangular miniature is made of resin and resembles a futuristic elevator with angular support beams. It is painted grey and shows minor wear due to production use and age, but remains in fine condition.

Dimensions: 6 cm x 4 cm x 2 cm (2 1/2" x 1 1/2" x 3/4")

£1,000-1,500



97. Rick Deckard's (Harrison Ford) Torn Shirt Ω

BLADE RUNNER (1982)

Rick Deckard's (Harrison Ford) torn shirt from Ridley Scott's sci-fi classic *Blade Runner*. During the climax of the film, Deckard wore his shirt while he was chased through an abandoned building by Nexus-6 replicant Roy Batty (Rutger Hauer). After Batty broke Deckard's hand, the Blade Runner ripped his shirt and used the fabric as a makeshift bandage.

This shirt is made from a synthetic fabric and features a repeating diamond pattern. The collar is detailed with a contrasting pattern and color scheme that is also used to flourish the top of each breast pocket. A tear is present on the bottom right panel of the shirt, from Deckard's attempt to mend his wounds.

The shirt is originally from the collection of Bill Thomas, and is accompanied by a letter of authenticity. The shirt shows intentional signs of wear from production use, and is in very fine condition.

£8,000-10,000



ScreenProd / Photonostop / Alamy Stock Photo



98. Matthew Yuricich Matte Painting — Bradbury Building Exterior Ω

BLADE RUNNER (1982)

A matte painting by Matthew Yuricich from Ridley Scott's sci-fi classic *Blade Runner*. Matte painting is one of cinema's oldest visual-effects techniques, used to extend sets and create scenery for films by means of a painted image rather than a physical set. This matte painting was used for the shot in which Deckard (Harrison Ford) fled from the replicant Roy Batty (Rutger Hauer) and climbed out of a window onto a ledge of the Bradbury building.

The painting is achieved using acrylic paints on a large sheet of masonite. The board features an unpainted section at the top right that has a pencilled layout where the live-action photography would overlap. The painting was deliberately rendered with a limited colour range, as the matte paintings were shot on a high-contrast film stock that enhanced the colour latitude of the image. The artwork is partially painted onto a large printed photograph of the live-action photography featuring Rutger Hauer and Harrison Ford — this enabled the effects artists to ensure a seamless blend between the painting and the live-action photography.

Written at the top left corner of the board is the date "8-12-81", along with "FX 92", "H=5o", and "V=5o". The piece was recently cleaned and given an extremely minimal touch-up by uncredited *Blade Runner* matte artist Rocco Gioffre. The piece remains in fine condition.

Dimensions: 203 cm x 96.5 cm x 0.5 cm (80" x 38" x ¼")

Please note this lot is sold without copyright, reproduction rights, licencing agreements or any other type of legal release.

£6,000-8,000

99. Matthew Yuricich Matte Painting — Building Exterior for Roy (Rutger Hauer) Saving Deckard (Harrison Ford) Ω

BLADE RUNNER (1982)

A matte painting by Matthew Yuricich from Ridley Scott's sci-fi classic *Blade Runner*. Matte painting is one of cinema's oldest visual-effects techniques, used to extend sets and create scenery for films by means of a painted image rather than a physical set. This matte painting was used for the shot in which the replicant Roy Batty (Rutger Hauer) saved Deckard (Harrison Ford) from falling off a roof.

The painting is achieved using acrylic paints on a large sheet of masonite. The board features dark buildings looming over Roy Batty and Deckard, as Deckard hangs from a ledge. The painting was deliberately rendered with a limited colour range, as the mattes were shot on a high-contrast film stock that enhanced the colour latitude of the image. The artwork is partially painted onto a large printed photograph of the live-action photography featuring Rutger Hauer and Harrison Ford — this enabled the effects artists to ensure a seamless blend between the painting and the live-action photography.

Rotoscope outlines of the characters' motion through the shot in each frame are also present, again to ensure the artwork was positioned in the exact correct spot. Written on a strip of tape at the top left corner of the board are "FX 96c", "H=5o" and "V=5o". The artwork features a black tape border and shows wear to the masonite due to production use and age. The piece was recently cleaned and given an extremely minimal touch-up by uncredited *Blade Runner* matte artist Rocco Gioffre. The piece remains in fine condition.

Dimensions: 204 cm x 97 cm x 0.5 cm (80 ¼" x 38 ¼" x ¼")

Please note this lot is sold without copyright, reproduction rights, licencing agreements or any other type of legal release.

£6,000-8,000



100. Jake "Joliet" Blues' (John Belushi) Sunglasses Ω

THE BLUES BROTHERS (1980)

Jake "Joliet" Blues' (John Belushi) sunglasses from John Landis' musical comedy *The Blues Brothers*. As brothers Elwood (Dan Aykroyd) and Jake (John Belushi) journeyed to Chicago, they wore their signature outfits, including Ray-Ban sunglasses.

These vintage sunglasses are produced by Ray-Ban and are the classic Wayfarer style in a tortoiseshell colour. One stem is marked with "B&L Ray-Ban U.S.A" while the other reads "Wayfarer". Each lens is specially treated with an anti-reflective coating in order to make filming the sunglasses an easier task. The sunglasses show some wear from use and storage, including some markings throughout and slight warping to the plastic, but are in fine overall condition. Originally from the estate of prop master Michael Miligrom.

Dimensions: 16.5 cm x 15 cm x 5 cm (6 1/2" x 6" x 2")

£8,000-10,000

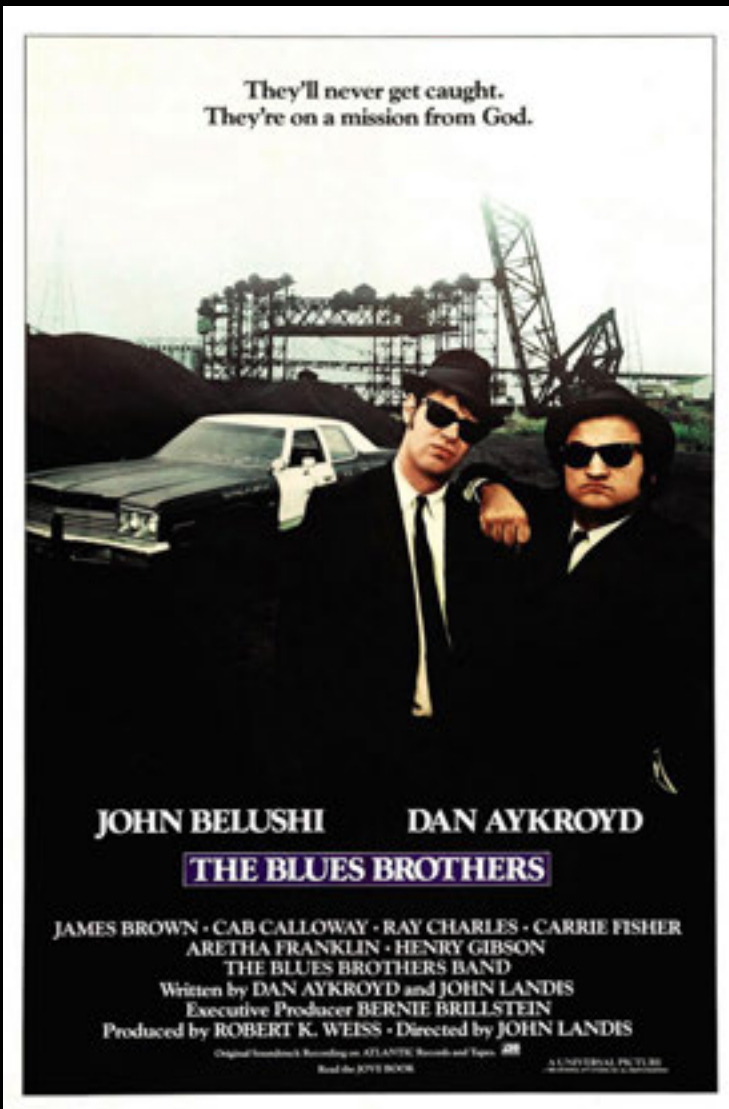

Kobal/REX/Shutterstock



101. Swollen Archibald Snatcher (Ben Kingsley) Stop-Motion Puppet Ω

THE BOXTROLLS (2014)

A swollen Archibald Snatcher (Ben Kingsley) stop-motion puppet from Graham Annable and Anthony Stacchi's stop-motion fantasy comedy *The Boxtrolls*. Snatcher disregarded his allergy for cheese throughout the film, which eventually resulted in severe swelling throughout his body at the climax of the film.

Made by animation studio Laika, this piece is designed for the meticulous process of stop-motion animation. It is constructed over a bendable metal armature that allows for the piece to be securely moved into countless poses. The skin is made of silicone and is painted in vibrantly coloured tones. The face comprises two pieces of 3D printed filament, which contain magnets for the quick removal and manipulation of Snatcher's facial expressions.

Snatcher's outfit is made from velvet and is stretched over his bloated body. The jacket features pieces of foam-latex cheese pieces, leftover from Snatcher's encounter with his favourite food. This piece shows some wear, including a tear to the silicone at the back, and is in fine overall condition.

Dimensions: 23 cm x 13 cm x 38 cm (9" x 5" x 15")

£6,000-8,000



102. Elisabeta (Winona Ryder) Miniature Puppet and Dracula's Bride (Florina Kendrick) Miniature Decapitated Head Ω

BRAM STOKER'S DRACULA (1992)

An Elisabeta (Winona Ryder) miniature puppet and Dracula's bride (Florina Kendrick) miniature decapitated head from Francis Ford Coppola's horror adaptation *Bram Stoker's Dracula*. Elisabeta leapt from a tower to her death at the beginning of the film. Later, Professor Abraham Van Helsing (Anthony Hopkins) decapitated Dracula's three brides.

Made of biscuit foam, the Elisabeta figure is hand-painted, with feathers glued to the scalp and hips. The dress is partially painted on, with the lower portion made of a green synthetic fabric. Two holes are drilled on the front and the base of the puppet where it was rigged for the effect.

The bride head is made of foam with faux hair glued on top. Gold-coloured earrings are attached at the ears, and a curvy metal wire is threaded through the hair. The puppet shows a crack at the waist and right arm, and is missing its right hand. Overall the lot is in fair condition. Dimensions (puppet): 18 cm x 10 cm x 5 cm (7" x 4" x 2"); (head) 10 cm x 15 cm x 15 cm (4" x 6" x 6")

£1,200-1,800



103. Jun Fan Gung Fu Membership Card †

BRUCE LEE

A Jun Fan Gung Fu membership card for *Bruce Lee's* celebrated martial-arts school. Presented in a black-and-gilt frame with a colour still of Bruce Lee as Kato from *The Green Hornet*, the blank membership card has spaces for the student's name and rank, along with expiry date and signature of the instructor and president.

This first-generation green-topped card was only issued to the elite students who attended one of the of legendary schools run by Bruce Lee in Seattle. The card is in excellent, unused condition.

Dimensions (card): 9 cm x 7 cm (3 ½ x 2 ½"); (displayed): 3 cm x 43 cm x 55 cm (1 ¼" x 17" x 21 ¾")

£800-1,200



104. Evan's (Ashton Kutcher) Childhood Journal Ω

THE BUTTERFLY EFFECT (2004)

Evan's (Ashton Kutcher) childhood journal from Eric Bress and J. Mackye Gruber's sci-fi thriller *The Butterfly Effect*. Evan discovered he had the ability to change the past by reading from his old journals.

This bespoke journal resembles a Mead Composition notebook, with large stickers adhered to the front and back covers that resemble Mead's traditional notebook-cover artwork. Written on the cover is "E. Treborn 1997". Inside the notebook are wide-ruled pages featuring a child's printed handwriting, which details various memories from Evan's early years. Also described are Evan's blackouts, which indicate the moments Evan changed the past. On the back cover is a strip of tape that reads "AGE 20" written in black ink, which likely came from another notebook. The journal shows intentional distressing to the paper to show age, but remains in very fine condition. Dimensions: 25 cm x 19 cm x 1 cm (9 ¾" x 7 ½" x ½")

£800-1,200

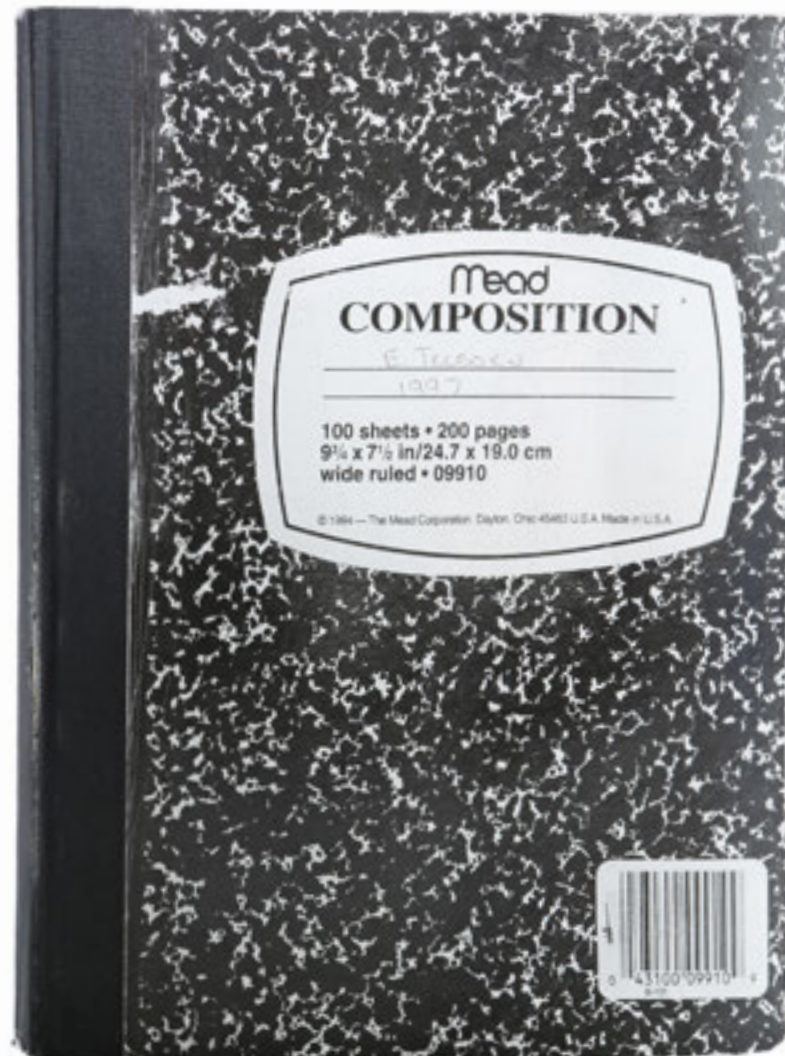
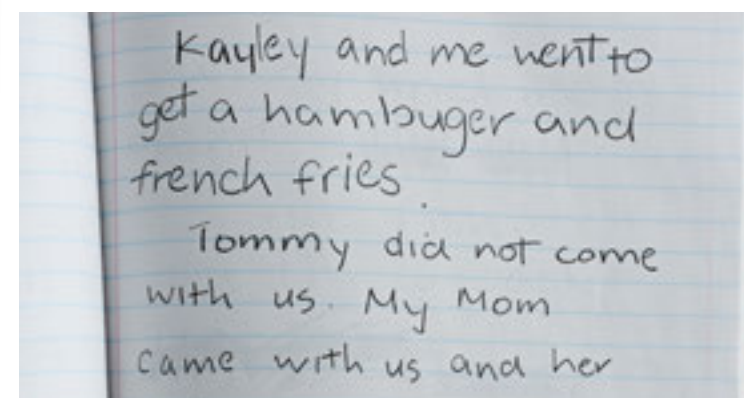

105. Victor Prinzim's (Dom DeLuise) Ambulance Jacket M

THE CANNONBALL RUN (1981)

Victor Prinzim's (Dom DeLuise) jacket from Hal Needham's action comedy *The Cannonball Run*. Posing as a paramedic, Prinzim wore his visually striking jacket throughout the film as he raced cross-country alongside J.J. McClure (Burt Reynolds) – re-enacting an actual race undertaken by the director himself in 1979.

Constructed from Nylon, the bright orange jacket (marked size "XL") features an embroidered patch sewn to the left breast pocket. Each sleeve has a blue-and-white striped band, and three pockets adorn the front. Handwritten on the interior collar is "Paramedic". Accompanying the jacket is a certificate of authenticity from the costume suppliers and an original wardrobe production tag. The garment shows age and wear, including stains on the front and collar, and discoloration on the arm cuffs. Two labels reading "Heinz" and stitch holes on either sleeve remain from use in a subsequent production.

£1,500-2,500



106. Captain America's (Reb Brown) Helmet Ω

CAPTAIN AMERICA II: DEATH TOO SOON (1979)

Captain America's (Reb Brown) helmet from Ivan Nagy's 1979 television movie *Captain America II: Death Too Soon*. Steve Rogers wore his helmet each time he sprung into action as Captain America.

This helmet is a modified motorcycle helmet that is painted in the blue-and-white Captain America aesthetic. The interior has a purple velvet lining and includes a blue leather chinstrap that fastens via Velcro. The exterior of the helmet features a large "A" flanked on both sides by foam-latex wings. This foam shows wear to the paint, and the original paint is only visible along the edges. This piece shows markings to the paint throughout and it is in fair overall condition.

Dimensions: 28 cm x 23 cm x 28 cm (11" x 9" x 11")

£800-1,200



107. Captain America's (Chris Evans) Distressed Army Rescue Costume Ω

CAPTAIN AMERICA: THE FIRST AVENGER (2011)

Captain America's (Chris Evans) distressed Army rescue costume from Joe Johnston's superhero film *Captain America: The First Avenger*. Steve Rogers wore his Captain America tour costume beneath Army fatigues when he infiltrated Johann Schmidt's (Hugo Weaving) Hydra base in order to rescue his friend Bucky Barnes (Sebastian Stan) and other captured soldiers of the 107th. This costume is screen-matched to the scene in which Captain America returned to Colonel Phillips' (Tommy Lee Jones) base of operations with the rescued soldiers.

Captain America's costume comprises a blue helmet, a pair of goggles, a leather jacket, webbing, an emblem tunic, a pair of paratrooper trousers, a belt, and a pair each of leather gloves, spats and leather boots. The blue helmet is outfitted with padding and straps for a snug fit, with a white stencilled "A" on the front. Inside the dome are four labels that read "STUNT", "#2" and "STAGE 2", and a printed barcode that also reads "FROSTBITE MARVEL 82021" (Frostbite being the production's working title). The paratrooper goggles feature suede padding and wrap around the helmet with an elastic strap.

The brown leather jacket is thoroughly distressed by the production, with numerous tears on the sleeves and front panels. Inside the jacket lining is a barcode that reads "Marvel CAP 88979". Worn under the jacket is Steve's "Captain America" tunic from his vaudeville-inspired touring musical, which he wore while entertaining troops to boost their moral. Stitched to the jacket is a green nylon webbing rig, which includes numerous pouches that are filled with foam. Fitting like a leotard, the tunic resembles the American flag and is made of spandex, with an embroidered white star over a blue chest with white sleeves and a red-and-white panelled abdomen. The back of the tunic mirrors the front and includes a hidden zipper. Inside the tunic is a handwritten label that reads "STEVE ROGERS SC 144", and another "Marvel CAP 68441" barcode.

The paratrooper trousers are made of cotton and show distressing to the fabric, along with a large production-made hole below the left knee. The trousers include a nylon belt that features a Western Costume label. Also worn on the legs are spats, and a pair of leather boots. Inside the right boot is a barcode which reads "Marvel CAP 67549".

The costume exhibits intentional production distressing, while also showing some additional wear with a few cracks in the helmet, and is missing the zipper slider. Aside from the noted wear, the complete costume remains in very fine overall condition. Obtained through an official Marvel Studios auction.

£40,000-60,000



108. Captain America's (Chris Evans) Hero Vibranium Shield Ω

CAPTAIN AMERICA: THE FIRST AVENGER (2011)

Captain America's (Chris Evans) vibranium shield from Joe Johnston's superhero film *Captain America: The First Avenger*. Developed by Howard Stark (Dominic Cooper) using vibranium, the rarest metal on the planet, Steve Rogers/Captain America chose this prototype to be his signature shield, over the other options presented to him by Stark. To demonstrate its merit, Agent Peggy Carter (Hayley Atwell) shot at the shield without warning.

Made of polished aluminium, the rounded shield features a panelled assembly and includes two handles at the back. The shield shows light surface scratches due

to production use, and there is no longer padding secured to the grips. However, the shield remains in very fine condition. It is accompanied by an official Marvel Studios certificate of authenticity.

Dimensions: 62 cm x 62 cm x 7 cm (24 ½" x 24 ½" x 2 ¾")

£20,000-30,000

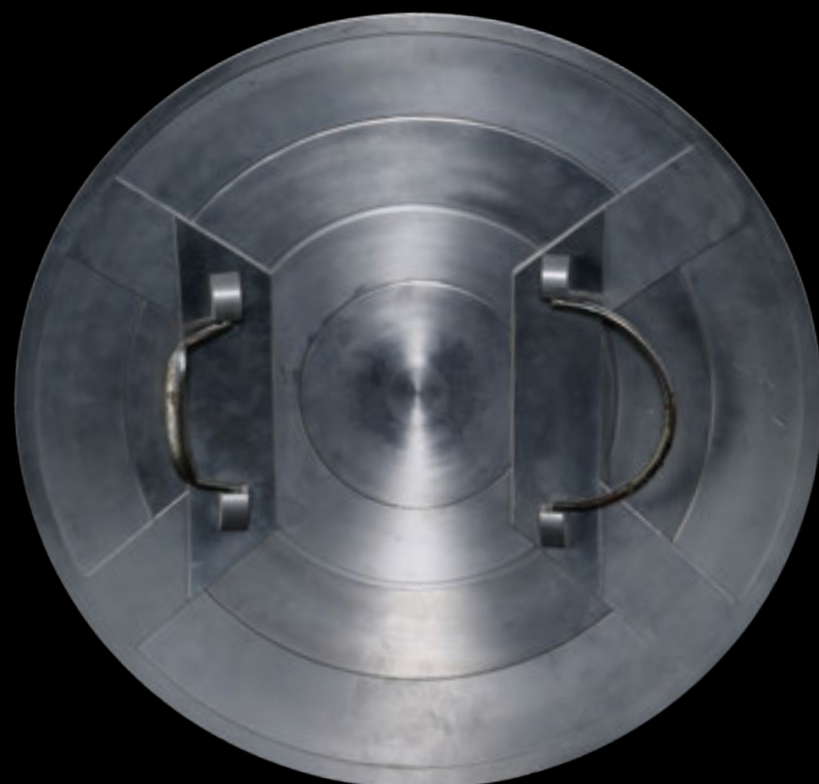

Everett Collection Inc / Alamy Stock Photo

109. Mort Lawrence Hand-Drawn Captain America Page Five Artwork Ω

CAPTAIN AMERICA / MEN'S ADVENTURES #27 (1954)

Hand-drawn artwork by Mort Lawrence used to produce page five of the Captain America story in Men's Adventures #27. Captain America appeared in very few comics during the 1950s, with one of his rare adventures being The Girl Who Was Afraid, published in Men's Adventures #27. The story sends Captain America and Bucky Barnes to Egypt to fight communism.

This artwork is from one of only three Captain America stories still known to exist from the '50s, and is one of the last stories to feature Captain America's original sidekick Bucky Barnes. When Captain America re-emerged in 1964 in the pages of Avengers #4, Bucky had apparently perished in an explosion that had thrown Captain America into icy water, where he remained frozen until discovered by the Avengers.

This original pencilled-and-inked artwork is drawn on illustration board by Mort Lawrence. The artwork features seven panels, each showing Captain America.

Included with the lot is a reference copy of Marvel Super-Heroes #14 (1968), the first comic book to reprint the Captain America story from Men's Adventures #27. Some minor stains and white-out correction fluid is present, and the board has a hole at each of its corners with light creasing in some areas. The artwork is in very good condition.

Dimensions: 49.5 cm x 33 cm (19 1/2" x 13")

Please note this lot is sold without copyright, reproduction rights, licencing agreements or any other type of legal release.

£5,000-7,000



110. Carlito Brigante's (Al Pacino) Suit M

CARLITO'S WAY (1993)

Carlito Brigante's (Al Pacino) suit from Brian De Palma's crime drama *Carlito's Way*. Brigante wore his suit in a nightclub as he celebrated his recent release from prison with close friend and lawyer, Kleinfeld (Sean Penn), and can be screen matched to scenes at a party as Kleinfeld begged for Brigante's help in a prison break.

Made of dark grey sharkskin fabric, the suit comprises matching jacket, waistcoat and trousers. The jacket displays wide lapels and black-and-grey marble-effect buttons running down the front, with a "Scafati New York" manufacturers label sewn to the inside pocket. The waistcoat features matching marbled buttons, with a black silk back panel and four small pockets on the front. The suit has various small plucks to the fabric due to age and use, but remains in very good condition.

£5,000-7,000



111. Charlie Chaplin's (Robert Downey Jr.) Cane M

CHAPLIN (1992)

Charlie Chaplin's (Robert Downey Jr.) cane from Richard Attenborough's Oscar®-nominated biopic *Chaplin*. Charlie carried his cane in multiple scenes while he played the Tramp, impressing Hollywood comedy producer Mack Sennett (Dan Aykroyd). Chaplin created the iconic look of the Tramp when he seized several items from a communal male dressing room at a studio in Hollywood. Crafted from resin, the cane displays a ridged design with cast-in texture and has been finished in varying shades of brown paint to resemble bamboo. The top end of the cane is curved to form a handle. The bottom of the cane displays paint wear exposing the resin underneath, with minor additional wear from use on production.

Dimensions: 85 cm x 12 cm x 2 cm (33 1/2" x 4 3/4" x 3/4")

£3,000-5,000

112. Richard Attenborough's Personal Annotated Script †Δ

CHAPLIN (1992)

Richard Attenborough's personal annotated script from the Academy Award nominated biopic *Chaplin*. Originating from Attenborough's estate, this script was used by the director, and many of the pages feature his personal notes and amendments, all handwritten in black marker.



The white card cover features a cut-out window revealing the film's original working title, "Charlie". Dated March 1991, the script is credited to screenwriter William Boyd and consists of 122 single-sided white A4 pages. The script displays minor marks on the card cover from production use. Dimensions: 30 cm x 22 cm x 2 cm (12" x 8 3/4" x 3/4")

£800-1,200



113. Hero Light-Up Necromonger Rifle †Δ

THE CHRONICLES OF RIDDICK (2004)

A hero light-up Necromonger rifle from David Twohy's sci-fi epic *The Chronicles of Riddick*. The Necromongers used their rifles throughout the film. This weapon is made of resin with a resin side grip, functioning trigger and light-up action. It is highly detailed, with an array of ornate designs running down the sides and has had a tarnished steel and faux-bronze finish.

The light-up action uses three U-shaped strobe lights housed in the central chamber, powered by two 9V batteries, for a firing effect. A small switch on the right side of the prop weapon activates the action. Displaying wear to the paint finish on the grip and frame from use, the weapon remains in good condition. Dimensions: 49 cm x 18 cm x 17 cm (11" x 6 1/4" x 6")

As this item contains electronic components, every effort has been made to describe them accurately. However, no guarantee or warranty is made as to functionality, lifespan or safety of those components. It is entirely incumbent on the new owner to satisfy themselves as to their safe use and maintenance.

£2,000-3,000

114. Dame Vaako's (Thandie Newton) Costume and Wig Ω

THE CHRONICLES OF RIDDICK (2004)

Dame Vaako's (Thandie Newton) costume and hairpiece from David Twohy's sci-fi sequel *The Chronicles of Riddick*. Dame Vaako wore her dress throughout the film.

The bespoke dress is made from a translucent synthetic mesh material and decorated with urethane scaling throughout. At the waist is a metal belt with an ornate centrepiece. Dame Vaako's hairpiece is made of faux hair, while her decorative hair support is made of metal. Also included are Dame Vaako's platform heels, which are outfitted with similar urethane scaling to match the style of the dress. The costume shows some wear, with portions of the scaling peeling away; however, the lot remains in fine condition.

£3,000-5,000

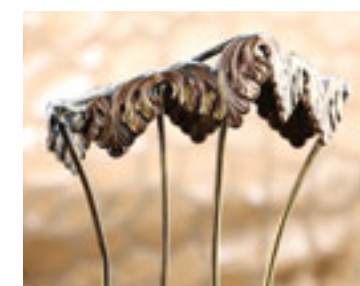

115. Vaako's (Karl Urban) Gold Armour Ω

THE CHRONICLES OF RIDDICK (2004)

Vaako's (Karl Urban) gold armour from David Twohy's sci-fi sequel *The Chronicles of Riddick*. The Necromonger warrior Vaako wore his gold armour after reaching the rank of general.

This costume consists of a helmet, coif, cuirass, pauldrons, gauntlets, Faulds, spaulders and a bodysuit. The armour is made of urethane, with the exception of the fibreglass helmet, and each piece is painted to resemble real metal. A custom spandex bodysuit is worn under the armour and features urethane scaling details.

The Faulds, cuirass, pauldrons and bodysuit are marked internally for Vaako. However, the boots and spaulders are standard-issue Necromonger commander components that have been added to complete the costume. The costume shows some signs of wear, including some distressing to the spandex, but remains in fine condition.

£3,000-5,000



116. Necromonger Captain Costume and Hero Pistol †Δ

THE CHRONICLES OF RIDDICK (2004)

A Necromonger Captain costume and hero light-up pistol from David Twohy's *The Chronicles of Riddick*. The Necromonger Captains can be seen throughout the film as they lead their army of zealots in their bid to convert the universe to their dark religion. Only Riddick (Vin Diesel) and the "breeders" stand in their way.

The costume consists of a fiberglass helmet with face guard and spine of spikes along the centre; armoured chest and back sections with spiked plates at each shoulder; a Lycra undersuit with rubber armour panels; a Lycra cowl and full cloak, both with rubber scaled detailing; a faux leather belt with rubber codpiece; leather boots (size 12); and gloves with rubber spikes at the knuckles. The armour has a distressed steel finish, adding to the fearsome look of the costume.

The hero weapon is made of resin, fiberglass and metal with a functioning trigger and light-up action that features quick-firing LEDs housed in the central chamber, powered by two 9v batteries. A small switch on the left side, activates the action. It is highly detailed with an array of ornate designs running down the sides and has had a tarnished steel and bronze-coloured finish in keeping with the design of the Necromonger armour. Displaying wear to the paint finish on the grip and frame from use, the weapon remains in good condition. Well used, the costume and pistol display signs of production wear and remains in good condition. Dimensions (costume, displayed): 65 cm x 68 cm x 198 cm (25 1/2" x 26 3/4" x 78"); (pistol): 28 cm x 5 cm x 16 cm (11" x 2" x 6 1/4")

As this item contains electronic components, every effort has been made to describe them accurately; however no guarantee or warranty is made as to functionality, lifespan or safety of those components. It is entirely incumbent on the new owner to satisfy themselves as to their safe use and maintenance.

£2,000-3,000



117. Necromonger Infantry Costume and Stunt Pistol †Δ

THE CHRONICLES OF RIDDICK (2004)

A Necromonger infantry costume and stunt pistol from David Twohy's *The Chronicles of Riddick*. The army of Necromongers roam the universe in their bid to convert everyone to their dark religion. Only Riddick (Vin Diesel) and the "breeders" stand in their way.

The fearsome costume consists of a rubber helmet with face mask; armoured chest and back sections; a Lycra undersuit with rubber armour panels; a Lycra cowl with rubber scaled detailing; a faux-leather belt with rubber codpiece; leather boots (UK size 10.5, US 11); and gloves with rubber spikes at the knuckles. The armour has a distressed steel finish, adding to the fearsome look of the costume. Completing the ensemble is a stunt pistol, cast in rubber and finished in grey.

The costume and pistol display signs of production wear, with minor damage to the armour it remains in good condition. Dimensions(displayed): 33 cm x 63 cm x 193 cm (13" x 24 1/2" x 75 1/2 ")

£800-1,200



118. Lord Marshal's (Colm Feore) Stunt Armour Ω

THE CHRONICLES OF RIDDICK (2004)

Lord Marshal's (Colm Feore) stunt armour from David Twohy's sci-fi sequel *The Chronicles of Riddick*. Lord Marshal served as the sixth Lord Marshal of the Necromongers and took the empire down a dark path. He wore his armour while he fought Riddick (Vin Diesel) and Vaako (Karl Urban) during the film's climax.

This lot consists of two spandex bodysuits, a coif, cuirass, pauldrons, codpiece, rerebraces, couters, faulds, cuisses, poleyns and greaves. Each rerebrace is a replica produced in order to complete the costume. The armour is made of urethane, with the exception of the coif. The coif is constructed from a combination of resin and metal pieces which adorn Lord Marshal's scalp. The decorative pieces are attached to a cowl made of fabric and painted to appear as metal. The spandex bodysuits have the cuisses and poleyns sewn to the thighs, and a zip at the back.

The faulds, couters, cuirass, pauldrons, cuisses, codpiece and one bodysuit are marked internally for stunt performers. However, the boots, one bodysuit, coif and spaulders are unmarked. The unmarked bodysuit has a large opening at the back from harness use. The costume shows some signs of wear, including some distressing to the spandex and a tear at the back of the right boot, but remains in fine condition.

£3,000-5,000



119. Riddick's (Vin Diesel) Costume †Δ

THE CHRONICLES OF RIDDICK (2004)

Riddick's (Vin Diesel) costume from David Twohy's sci-fi epic *The Chronicles of Riddick*. Riddick wore his signature costume throughout the film as he traversed the galaxy, from the frigid wastes of Planet U.V.6, to Helion Prime, to the prison planet of Crematoria.

The costume is composed of a custom-made grey vest and a pair of brown combat trousers. The vest is covered in small runes and characters running in lines across the fabric. The trousers have a net finish over the tops of the legs and feature an array of pockets and straps, with stirrups at the bottoms of the legs. Displaying only minor wear from use, the costume remains in very good condition.

£600-800

120. Matthew Yuricich Matte Painting — Mothership Top for Finale Landing Ω

CLOSE ENCOUNTERS OF THE THIRD KIND (1977)

A matte painting by Matthew Yuricich from Steven Spielberg's sci-fi classic *Close Encounters of the Third Kind*. Matte painting is one of cinema's oldest visual-effects techniques, used to extend sets and create scenery for films by means of a painted image rather than a physical set. This matte painting was used for the shot in which an alien mothership touched down at the military base on Devil's Tower. The artwork served as the top of the alien spacecraft and as an extension of the practical light-up model.

The painting is achieved using acrylic paints on a large sheet of masonite, with the artwork located at the top portion of the board. Below the art is a large surface covered in a black wash, where the live-action photography would overlap. Notably, the artwork features the first names of numerous members of the crew hidden in the top panels, including Douglas Trumbull, Larry Albright, Richard Yuricich,

Joyce Goldberg, Mona Thal Benefiel, and Steven Spielberg. Written on a wide piece of white gaffer tape at the top left corner of the board are shot references "R5-10+45", "R6-32+68" and "H=6 V=6".

The artwork shows wear to the masonite due to production use and age, and was recently cleaned and given an extremely minimal touch-up by assistant matte artist Rocco Gioffre. The piece remains in fine condition.

Dimensions: 204 cm x 96.5 cm x 0.5 cm (80 ¼" x 38" x ¼")

Please note this lot is sold without copyright, reproduction rights, licensing agreements or any other type of legal release.

£2,000-3,000

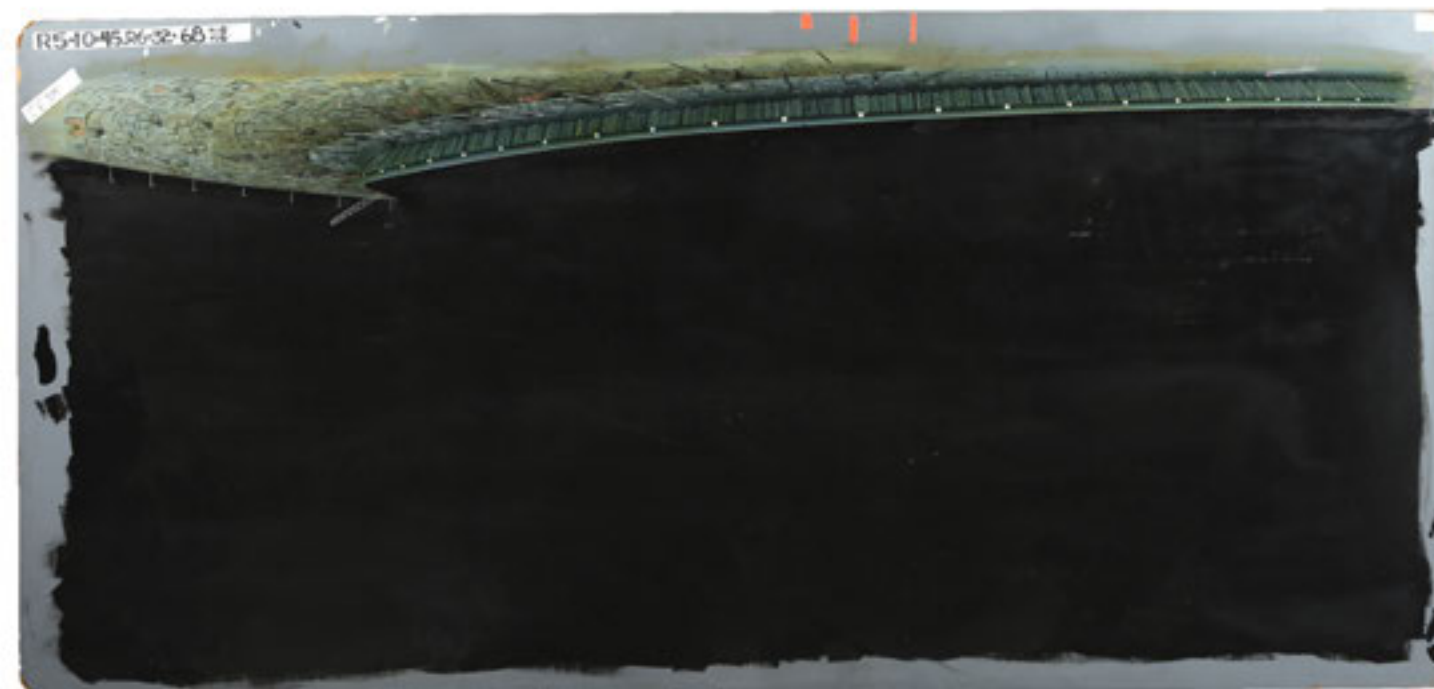

121. Matthew Yuricich Matte Painting — Sky Behind Devil's Tower Ω

CLOSE ENCOUNTERS OF THE THIRD KIND (1977)

A matte painting by Matthew Yuricich from Steven Spielberg's sci-fi classic *Close Encounters of the Third Kind*. Matte painting is one of cinema's oldest visual-effects techniques, used to extend sets and create scenery for films by means of a painted image rather than a physical set. This matte painting was used to create a remarkable cloud formation in the sky behind Devil's Tower for the scene in which the clouds took on an otherworldly appearance as the Mothership arrived.

The painting is achieved using acrylic paints on a large sheet of masonite, and shows a deep blue sky with swirling clouds. A large area is painted grey, where the live-action footage of Devil's Tower would overlap. A tree is painted on the

left side of this massive rock formation. Written at the top left corner of the board is "CN-24". The artwork shows minor wear to the masonite due to production use and age. The piece was recently cleaned and given an extremely minimal touch-up by assistant matte artist Rocco Gioffre. It remains in fine condition.

Dimensions: 203 cm x 96.5 cm x 0.5 cm (80" x 38" x ¼")

Please note this lot is sold without copyright, reproduction rights, licensing agreements or any other type of legal release.

£1,000-2,000



122. Matthew Yuricich Glass Matte Painting — Devil's Tower Landscape US

CLOSE ENCOUNTERS OF THE THIRD KIND (1977)

A glass matte painting by Matthew Yuricich from the production of Steven Spielberg's sci-fi classic *Close Encounters of the Third Kind*. Matte painting is one of cinema's oldest visual-effects techniques, used to extend sets and create scenery for films by means of a painted image rather than a physical set. Unseen in the final film, this matte painting shows the Devil's Tower rock formation from a low angle.

The painting is achieved using acrylic paints on a large glass panel and depicts a tree-lined rocky base at the foot of Devil's Tower. Written on a strip of tape at the top left corner of the glass are "R2-4,11, 20" and "FRONT FOCUS". The glass

artwork is housed in an aluminium frame and shows minor wear to the metal due to production use and age. The piece was recently cleaned and given an extremely minimal touch-up by assistant matte artist Rocco Gioffre. It remains in fine condition.

Dimensions: 183 cm x 96.5 cm x 1.5 cm (72" x 38" x ½")

Please note this lot is sold without copyright, reproduction rights, licensing agreements or any other type of legal release.

£2,000-3,000





123. Albion Replica Atlantean Sword Ω

CONAN THE BARBARIAN (1982)

A replica Atlantean sword, produced from the original moulds used during the making of John Milius' action adventure *Conan the Barbarian* (1982). The Atlantean sword was discovered by Conan (Arnold Schwarzenegger) in an ancient tomb and became the signature weapon of the Cimmerian warrior, used throughout the film as he battled against the Cult of Set and Thulsa Doom (James Earl Jones).

Manufactured by Albion Swords Ltd, the heavy metal sword features a cast pommel and cross guard decorated with skulls, creatures and Atlantis-influenced motifs. Ancient characters are engraved on the both sides of the blade towards the guard, and the grip is finished with wrapped brown twine. Etched to the side of the guard is the official trademark "©Conan Properties Inc, 2003". The weapon's point remains sharp and the blade shows minor black tarnishing and paint chips are present on the guard.

Dimensions: 100 cm x 18 cm x 4 cm (39 1/2" x 7" x 1 1/2")

£4,000-6,000



124. Albion Replica Father's Sword Ω

CONAN THE BARBARIAN (1982)

A replica Father's Sword created from the original moulds used during the making of John Milius' action adventure *Conan the Barbarian* (1982). Forged by Conan's Father (William Smith), the sword was taken by Thulsa Doom (James Earl Jones) after his raid on the Cimmerian village. Later, after it was shattered in battle with Rexor (Ben Davidson), Conan (Arnold Schwarzenegger) used its shards to defeat his enemy and avenge his people.

Handcrafted in metal by Albion Swords Ltd, the sword features a distinctive skull cross guard and decorative pommel. Running down the length of the blade on both sides is the text "Suffer No Guilt Yee Who Wield This In The Name Of Crom", engraved in an ancient-looking font. The grip is finished with wrapped brown leather. The weapon shows minor paint chips on the guard and the blade's point remains sharp.

Dimensions: 98 cm x 15 cm x 6 cm (38 1/2" x 6" x 2 1/2")

£4,000-6,000

125. Ron Cobb Hand-Painted Tomb of the Atlantean General Artwork Ω

CONAN THE BARBARIAN (1982)

Hand-painted artwork depicting the Tomb of the Atlantean General from John Milius' action adventure *Conan the Barbarian* (1982). Rendered by production designer Ron Cobb, the illustration shows Conan (Arnold Schwarzenegger) in the tomb where he acquired the ancient Atlantean sword. The painting was published in a special April 1982 double issue of *Cinefantastique* magazine as part of the film's promotional campaign.

Dimensions (artwork): 72 cm x 31 cm (28 1/2" x 12 1/4");
 (illustration board): 81 cm x 51 cm x 1 cm (32" x 20" x 1/4")

Please note this lot is sold without copyright, reproduction rights, licensing agreements or any other type of legal release.

Painted with gouache on illustration board, the artwork shows Conan kneeling by a fire in a tomb where a skeletal warrior sits on a throne. The board shows minor wear due to use and age with a few dents to the perimeter, but the art remains in very fine condition.

£3,000-5,000

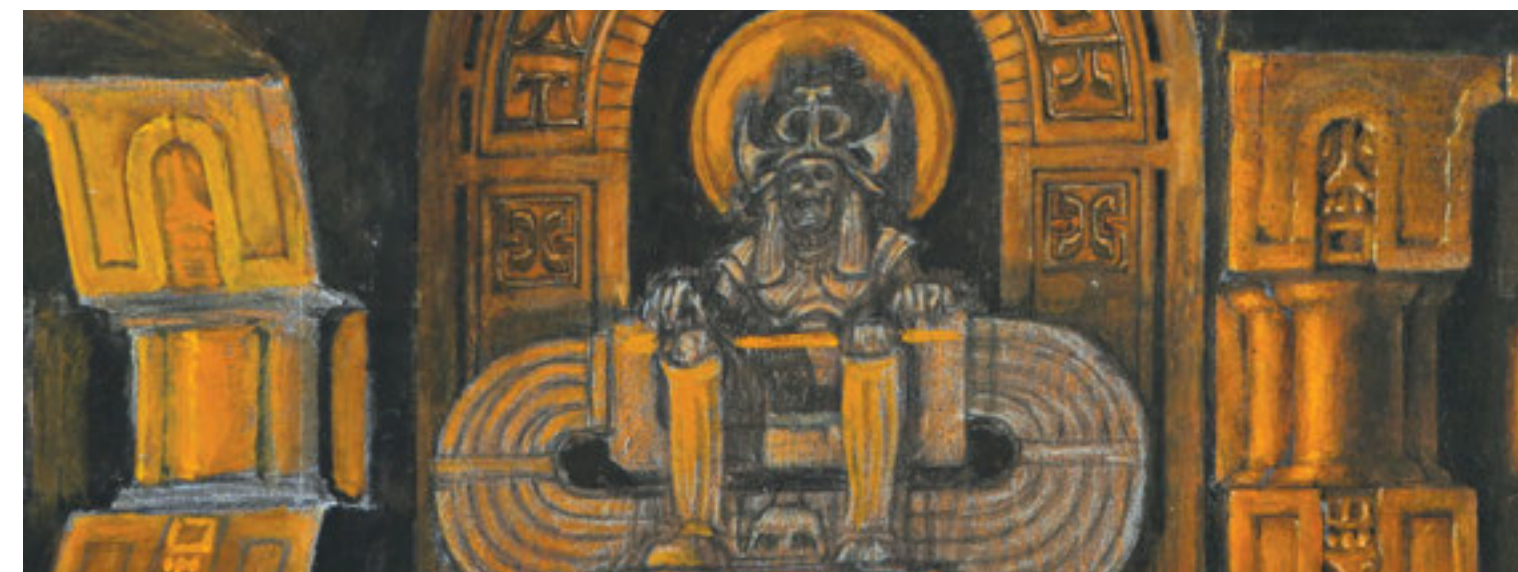
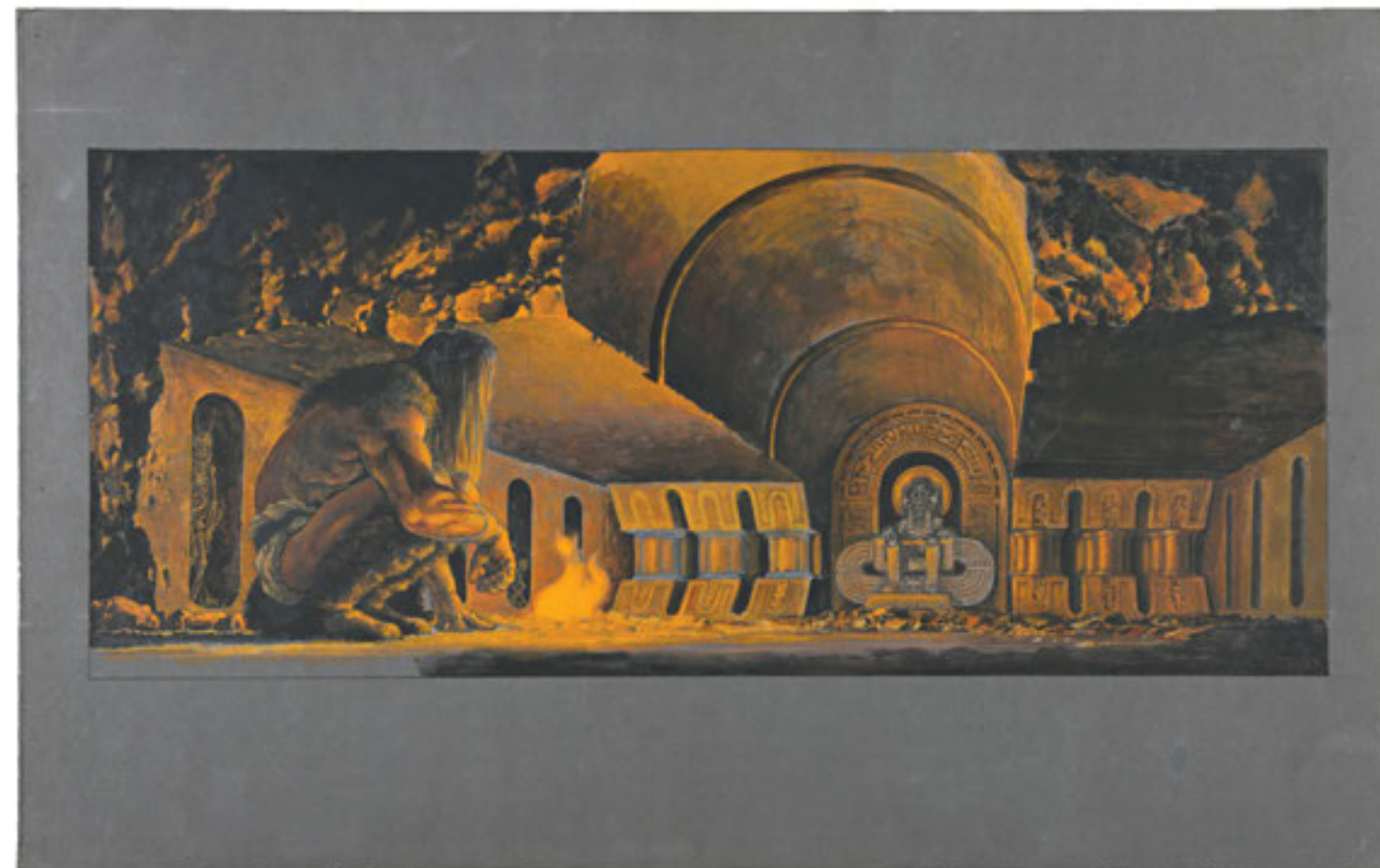

126. Ron Cobb's Personal Annotated Script Ω

CONAN THE BARBARIAN (1982)

Ron Cobb's personal annotated script from the production of John Milius' action adventure *Conan the Barbarian*. The script was used by production designer Ron Cobb and is filled with handwritten notes.

Dated "20/10/80", this third-draft revised screenplay was written by director John Milius and consists of 121 single-sided off-white US letter pages. The cover page shows "Ron Cobb" written at the top right corner, with numerous telephone numbers written in blank spaces. The blue card cover shows some tears, and the script paper is tinted with age, but the lot remains in fine condition. Dimensions: 22 cm x 28.5 cm x 2.5 cm (8 ¾" x 11 ¼" x 1")

Please note this lot is sold without copyright, reproduction rights, licensing agreements or any other type of legal release.

£800-1,000



127. Ron Cobb Hand-Drawn Conan Concept Artwork and Printed Crom Emblem Designs Ω

CONAN THE BARBARIAN (1982)

A set of hand-drawn concept designs from John Milius' action adventure *Conan the Barbarian* (1982). The set of artworks, illustrated by production designer Ron Cobb, depict early concepts of Conan (Arnold Schwarzenegger) and designs for an emblem for the Cimmerian god, Crom.

The set consists of two pencil-drawn images on tracing and white paper. One features an image of Conan beside a rough sketch for his helmet, and the other shows an elder with his arms crossed. Accompanying the drawings are two matching prints of the Crom emblem with text beneath reading, "Sign of Crom". The artwork remains in very good condition, with minor edgewear. Dimensions (largest artwork): 23 cm x 30 cm (9" x 12")

Please note this lot is sold without copyright, reproduction rights, licensing agreements or any other type of legal releases.

£800-1,200



128. Ron Cobb Hand-Drawn Set Emblem, Amulet and Giant Snake Designs Ω

CONAN THE BARBARIAN (1982)

A set of hand-drawn concept designs from John Milius' action adventure *Conan the Barbarian* (1982). Created by production designer Ron Cobb, the artwork depicts early concept designs for emblems and amulets of the Cult of Set, led by the mystical warlord Thulsa Doom (James Earl Jones).

The set comprises nine sheets of snake-influenced designs, rendered in pencil and ink on tracing and white paper. One image features a concept for an amulet with an eye detail surrounded by two snakes, and another for the giant snake Conan (Arnold Schwarzenegger) slays in the cult's inner sanctum. The sketches show minor wear from age and production use, including slight edge creases and pencil smudges, while one sheet has a small tear on the top edge. Dimensions (largest artwork): 23 cm x 30.5 cm (9" x 12")

Please note this lot is sold without copyright, reproduction rights, licensing agreements or any other type of legal releases.

£800-1,200



129. Set of Five Behind-The-Scenes Polaroids Ω

CONAN THE BARBARIAN (1982)

A set of five behind-the-scenes Polaroid photos from the set of John Milius' action-adventure *Conan the Barbarian* (1982). The images were captured on the campfire set in the Spanish Ciudad Encantada rock formations after Conan (Arnold Schwarzenegger) met Subotai (Gerry Lopez).

The photos depict the actors in conversation, and there is a shot of director Milius seated with producer Buzz Feltshans. The actors' hairstyles and headwear are different to those in the final cut, indicating that these were taken early in the production.

Two images are slightly out of focus, while the photos of the principal actors and crew are sharply realised with boldly preserved colours. The Polaroids show very minor marks from storage and production use. Dimensions: 11 cm x 9 cm x 0.5 cm (4 ¼" x 3 ½" x ¼")

£300-500

130. Cultist Helmet Ω

CONAN THE BARBARIAN (1982)

A cultist helmet from John Milius' action adventure *Conan the Barbarian*. Conan (Arnold Schwarzenegger) infiltrated the Temple of Set during his quest to rescue a princess from the cult of Thulsa Doom (James Earl Jones).

Made of leather, the helmet features holes cut into the front for the wearer's eyes, and includes two crossed bands stitched on top. The leather is heavily distressed and has become misshapen over the years, with a few stray threads protruding from the back of the helmet. Dimensions: 23 cm x 23 cm x 23 cm (9" x 9" x 9")

£1,000-1,500



131. King's Guard Helmet Ω

CONAN THE BARBARIAN (1982)

A king's guard helmet from John Milius' action adventure *Conan the Barbarian*. Conan (Arnold Schwarzenegger) was arrested by King Osric's (Max Von Sydow) guards and tasked with rescuing his daughter from Thulsa Doom (James Earl Jones).

Made of fibreglass, the helmet features metal banding around the perimeter, and includes a hinged faceplate that covers the nose and mouth. The interior is lined with foam padding, and includes a buckled leather strap for fastening to the wearer. Showing minor cracks to the paint due to use and age, the helmet remains in very fine condition. Dimensions: 30.5 cm x 29 cm x 28 cm (12" x 11 ½" x 11")

£1,200-1,800



132. Ron Cobb Hand-Drawn Thulsa Doom Helmet, Set Temple Guard and Standard Designs Ω

CONAN THE BARBARIAN (1982)

A set of hand-drawn concept designs from John Milius' action adventure *Conan the Barbarian* (1982). Rendered by production designer Ron Cobb, the drawings depict early concepts of Thulsa Doom's (James Earl Jones) helmet, a Set temple guard's armour and several standard designs for the Cult of Set.

Featuring a snake theme throughout, the artwork consists of nine ink and pencil-drawn images on tracing and white paper. Labelled "T. Doom", one drawing features a concept for Doom's helmet, worn during the raid on the Cimmerian village. Another image is outlined in black ink and portrays a detailed sketch of a Set temple guard. The drawings remain in very good condition with minor creases, while one piece shows small tears along the top edge.

Dimensions (largest artwork): 35 cm x 28.5 cm (13 ¾" x 11 ¼")

Please note this lot is sold without copyright, reproduction rights, licensing agreements or any other type of legal releases.

£800-1,200

134. Ron Cobb Hand-Painted Poster Artwork Ω

CONAN THE BARBARIAN (1982)

Hand-painted artwork depicting an early poster concept for John Milius' action adventure *Conan the Barbarian*. Rendered by production designer Ron Cobb, the illustration depicts Conan (Arnold Schwarzenegger) and Valeria (Sandahl Bergman) on a cliff covered with serpents, with the helmet of Thulsa Doom (James Earl Jones) looming over them.

Painted with gouache on illustration board, the poster differs from the final version used for the film, but still features Conan and Valeria standing on a cliff with flames behind them. The board has a black-painted border and shows minor wear due to use and age, with a few dents to the perimeter. However, the art remains in very fine condition.

Dimensions (artwork): 46 cm x 61 cm (18" x 24");
(illustration board): 46 cm x 76 cm x 1 cm (18" x 30" x ¼")

Please note this lot is sold without copyright, reproduction rights, licensing agreements or any other type of legal releases.

£4,000-6,000

133. Ron Cobb Hand-Drawn Raider Commander Artwork Ω

CONAN THE BARBARIAN (1982)

Hand-drawn artwork depicting the raider commander from John Milius' action adventure *Conan the Barbarian*. Rendered by production designer Ron Cobb, the illustration depicts an early concept for the raiders who massacred Conan's (Arnold Schwarzenegger) village at the start of the film.

Drawn with pastels and water colours on illustration paper, the mixed media artwork shows a menacing warrior wearing an angular helmet and a bone necklace, while brandishing a sword and shield. Although the design for the raiders ultimately changed, the helmet design was kept for the raider commander.

The piece is taped around the perimeter to an illustration board that is painted with a brown wash on the front and back. While most of the tape has peeled away, the artwork remains adhered to the illustration board. The board shows minor wear due to use and age, with tack holes at the corners and tape residue around the perimeter. However, the artwork remains in very fine condition.

Dimensions (artwork): 67 cm x 38 cm (26 ½" x 15"); (illustration board): 71 cm x 49 cm x 1 cm (28" x 19 ¼" x ¼")

Please note this lot is sold without copyright, reproduction rights, licencing agreements or any other type of legal releases.

£1,500-2,500



135. Ron Cobb Hand-Drawn 'Pit Fighter I' Artwork Ω

CONAN THE BARBARIAN (1982)

Hand-drawn artwork depicting Conan (Arnold Schwarzenegger) in his battle against a pit fighter from John Milius' action-adventure *Conan the Barbarian*. Rendered by production designer Ron Cobb, the illustration is titled 'PIT FIGHTER I,' and was published in a special April 1982 double issue of Cinefantastique magazine as part of the film's promotional campaign.

Drawn with pencils on illustration board, the artwork depicts Conan standing over his bleeding opponent in the bottom of a pit, with dozens of slavers cheering on the battle below. The artwork shows 'CONAN' and 'PIT FIGHTER I' written at the bottom corners in pencil, and is signed 'R. COBB' vertically along the bottom right of the drawing. The piece shows wear due to use and age, with tack holes at the corners and tape residue around the perimeter; however, the art remains in very fine condition.

Dimensions: 51 cm x 38 cm x 1 cm (20" x 15" x ¼")

Please note this lot is sold without copyright, reproduction rights, licensing agreements or any other type of legal releases.

£1,500-2,500



137. Ron Cobb Hand-Drawn "The Tower Of Serpents" Artwork Ω

CONAN THE BARBARIAN (1982)

Hand-drawn artwork depicting the Tower of the Serpent from John Milius' action adventure *Conan the Barbarian*. Rendered by production designer Ron Cobb, the illustration is titled "The Tower Of Serpents" and shows an early concept for Thulsa Doom's (James Earl Jones) temple in Zamora where his snake cult worshipped the god Set. Conan (Arnold Schwarzenegger) infiltrated the tower, where he battled a giant snake.

includes an original mat-board frame which shows wear due to use and age, but the art remains in very fine condition.

Dimensions (artwork): 71 cm x 25 cm x 1 cm (28" x 9 ¾" x ¼"); (mat frame): 85 cm x 65 cm x 1 cm (33 ½" x 25 ½" x ¼")

Please note this lot is sold without copyright, reproduction rights, licencing agreements or any other type of legal releases.

£1,500-2,500

Drawn with pastels and coloured pencils on paper, the artwork shows a tall tower lit by the moon, with winding serpents carved into the structure. The artwork shows "CONAN" and "THE TOWER OF THE SERPENTS" written at the bottom corners in white pencil, and is signed "R. COBB" in blue at the bottom right. The piece



136. Ron Cobb Hand-Drawn Conan Pit Fighter Restraints Ω

CONAN THE BARBARIAN (1982)

Hand-drawn artwork depicting Conan (Arnold Schwarzenegger) restrained as a pit fighter from John Milius' action adventure *Conan the Barbarian*. Rendered by production designer Ron Cobb, the illustration was published in a special April 1982 double issue of Cinefantastique magazine as part of the film's promotional campaign.

Drawn with coloured pencil on illustration paper, the artwork shows Conan chained by the neck to a table, seated as a centerpiece before his captors. The foamcore backing shows minor wear due to use and age, with minor wrinkles to the illustration paper. However, the art remains in very fine condition.

Dimensions (artwork): 55 cm x 38.5 cm (21 ¾" x 15 ¼"); (mat frame): 73.5 cm x 56.5 cm x .5 cm (29" x 22 ¼" x ¼")

Please note this lot is sold without copyright, reproduction rights, licencing agreements or any other type of legal releases.

£2,000-3,000

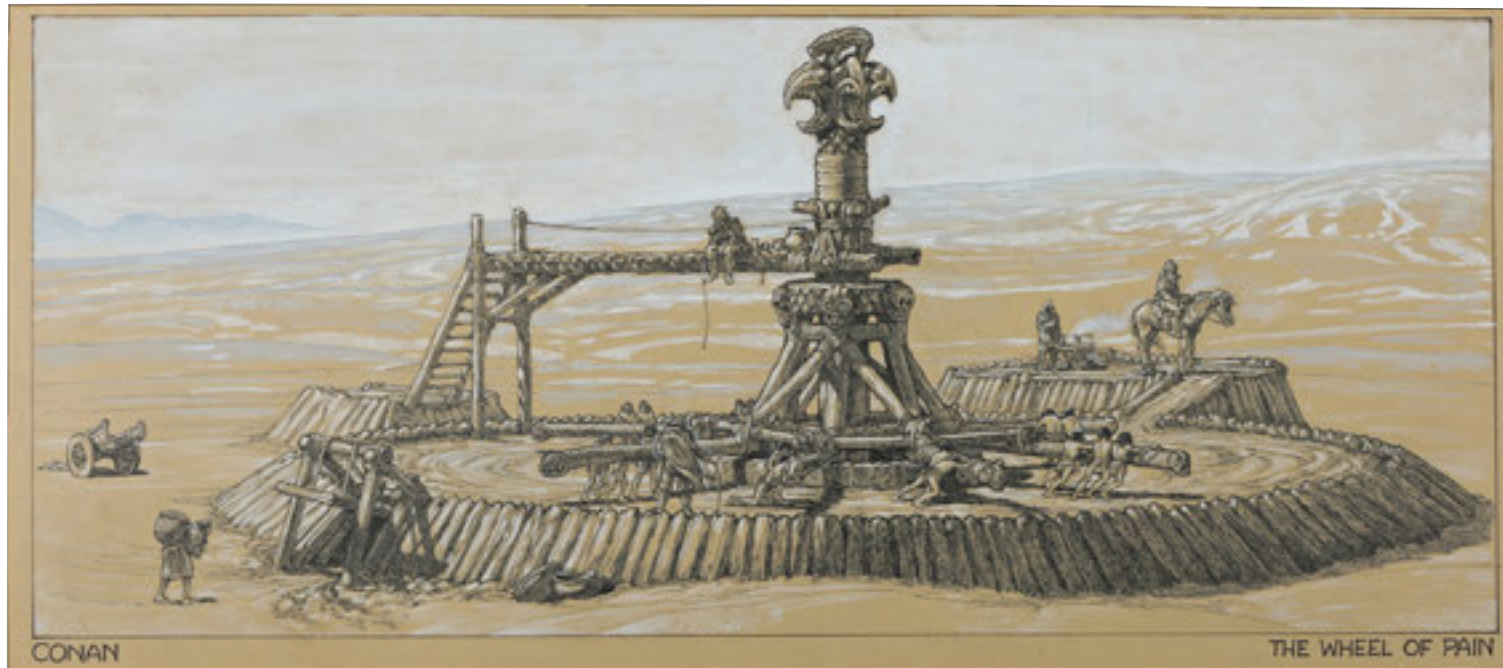

138. Ron Cobb Hand-Drawn "The Wheel Of Pain" Artwork Ω

CONAN THE BARBARIAN (1982)

Hand-drawn artwork depicting the Wheel of Pain from John Milius' action adventure *Conan the Barbarian*. Sold into slavery as a boy after his father was murdered, Conan (Arnold Schwarzenegger) was forced to work at The Wheel of Pain mill.

Rendered by production designer Ron Cobb, the illustration is titled "THE WHEEL OF PAIN" and was published in a special April 1982 double issue of *Cinefantastique* and the July 1982 issue of *Muscle Fitness* as part of the film's promotional campaign. Drawn with pastels and pen on illustration paper, the artwork shows children pushing a giant wheel around a large pillar as slave owners stand guard over them.

The artwork has "CONAN" and "THE WHEEL OF PAIN" written at the bottom corners in black ink. The piece includes an original mat-board frame and foamcore backing which shows wear due to use and age. However, the artwork remains in very fine condition. Dimensions (artwork): 74 cm x 33 cm x 1 cm (29" x 13" x ¼"); (mat frame): 90 cm x 48 cm x 1 cm (35 ½" x 19" x ¼")

Please note this lot is sold without copyright, reproduction rights, licencing agreements or any other type of legal releases.

£2,500-3,500



139. Ron Cobb Hand-Painted "The Enigma of Steel" Artwork Ω

CONAN THE BARBARIAN (1982)

Hand-painted artwork depicting the young Conan and his father from John Milius' action adventure *Conan the Barbarian*. Rendered by production designer Ron Cobb, the illustration is titled "THE ENIGMA OF STEEL" and was published in Ron Cobb's book, *Colorvision*, and the September 1981 issue of *Cinefantastique* magazine as part of the film's promotional campaign. Conan's father (William Smith) told his young son the story of the god Crom, and how giants stole the enigma of steel from the mighty deity.

Painted with gouache on illustration paper, the artwork shows young Conan and his father standing on a cliff, with a gleaming sword held up to the sky. The artwork has "CONAN" and "THE ENIGMA OF STEEL" written at the bottom corners in black ink. The piece includes an original matte board frame with foamcore backing, which shows wear due to use and age. However, the art remains in very fine condition.

Dimensions (artwork): 58.5 cm x 37 cm (23" x 14 ½"); (matte frame): 71 cm x 49 cm x 1 cm (28" x 19 ¼" x ¼")

Please note this lot is sold without copyright, reproduction rights, licencing agreements or any other type of legal releases.

£4,000-6,000

140. Conan's (Arnold Schwarzenegger) Axe Ω

CONAN THE BARBARIAN (1982)

Conan's (Arnold Schwarzenegger) axe from John Milius' action adventure *Conan the Barbarian*. Conan (Arnold Schwarzenegger) held his axe when he prayed to Crom for revenge, and wielded it in the sequence where he ambushed Thulsa Doom's (James Earl Jones) men.

The axe is made of fibreglass, with a rough textured axe-head that resembles rusted metal, and a long handle that is painted to resemble wood. The handle is wrapped in faux leather, although the handle seen on screen differs from this version.

This axe was likely used for close-ups or insert shots where the handle is not visible. The piece shows minor wear to the paint, with surface scratches, but remains in very fine condition.

Dimensions: 84 cm x 43 cm x 4 cm (33" x 17" x 1 1/2")

£15,000-20,000



141. John Constantine's (Keanu Reeves) Lighter Ω

CONSTANTINE (2005)

John Constantine's (Keanu Reeves) lighter from Francis Lawrence's supernatural horror film *Constantine*. John Constantine was dying of lung cancer, brought on by his chain-smoking, and the character had a cigarette in his mouth throughout the film. His signature lighter appeared in many scenes.

Made from a real lighter encased in brass and detailed with swirling engravings, the lighter features the St. Benedict medal inlaid on each side. Additionally, the Latin phrase "fiat iustitia, et pereat mundus" is engraved into one side of the lighter. This translates as "Let justice be done, and let the world perish".

The bottom of the lighter features an on/off switch that powers internal electronics which assisted the flame. These electronics remain untested. The lighter shows light signs of use, including portions of the finish that are wearing away, but remains in very fine overall condition.

Dimensions: 8 cm x 5 cm x 0.5 cm (3" x 2" x 1/2")

This item contains electronic components. While every effort is made to describe them accurately, no guarantee or warranty is made as to the functionality, lifespan or safety of those components. It is entirely incumbent on the new owner to satisfy themselves as to their safe use and maintenance.

£1,500-2,500



142. John Constantine's (Keanu Reeves) Stunt Holy Shotgun Ω

CONSTANTINE (2005)

John Constantine's (Keanu Reeves) stunt holy shotgun from Francis Lawrence's supernatural horror film *Constantine*. Constructed from numerous ancient relics, the demon-killing shotgun was used by John Constantine (Keanu Reeves) as he fought to save Angela Dodson (Rachel Weisz) from the clutches of Mammon.

Crafted from dense foam, the static stunt shotgun has a faux-gold-plated finish and features engraved Latin inscriptions and decoration inlaid throughout the weapon. A non-wind-up, rotating drum magazine with nickel plating is cast in front of the weapon's trigger.

Mounted to the top of the shotgun is a torch, with foil adhered to the tip to imitate the lens of a flashlight. At the tip of the barrel is a small crucifix.

The shotgun displays some wear from production use, including small breaks in the foam and chips to the paint. The item remains in very fine condition. Dimensions: 58.5 cm x 27 cm x 18 cm (23" x 10 3/4" x 7")

£3,000-5,000



143. Ball & Socket Lounge Patron Stop-Motion Puppet Ω**CORPSE BRIDE (2005)**

A Ball & Socket Lounge patron stop-motion puppet from Tim Burton's stop-motion film *Corpse Bride*. Victor Van Dort visited the Ball & Socket Lounge after being taken to the Land of the Dead. Various puppets, including this one, were made to populate the bar.

Based on Burton's unique, recognisable drawing style, the *Corpse Bride* puppets were created by the special effects production company Mackinnon and Saunders, one of the world's leading puppet-making companies, who previously collaborated with Burton on *Mars Attacks!*

Constructed around a poseable steel-and-aluminium armature, the puppet is made of intricately painted resin and silicone components. It is outfitted in velvet shoes, grey trousers and a grey coat, with bits of a faux undershirt sewn in.

The puppet is presented on an acrylic base that attaches to its feet through the same screw holes used to stabilise the piece during production. It shows evidence of age and production use, including scuffs to the shoes and jaw, and is in very fine overall condition. Dimensions: 18 cm x 18 cm x 44.5 cm (7" x 7" x 17 1/2")

£5,000-7,000**144. Animatronic Critter Puppet Ω****CRITTERS (1986)**

An animatronic Critter puppet from Stephen Herek's cult sci-fi horror film *Critters*. After landing in a small farming town, small aliens terrorised the citizens by trying to eat them. This puppet was made for the many scenes featuring a full Critter body.

Made of foam latex, the puppet has a large hole at its bottom, from which electronic wires emerge. These wires have been tied together in order to prevent motion and preserve the piece. The puppet features a combination of hand-punched and glued-on hair. The mouth is opened and the Critter's signature set of menacing teeth are clearly visible. Each eye is translucent and made of acrylic. In order to preserve its foam latex, the puppet has been sympathetically repaired and stabilised where needed. It shows some signs of wear from age, such as cracking and hardening to the foam, and is in fair overall condition.

Dimensions: 35.5 cm x 20.5 cm x 15 cm (14" x 8" x 6")

This item contains electronic components. While every effort is made to describe them accurately, no guarantee or warranty is made as to the functionality, lifespan or safety of those components. It is entirely incumbent on the new owner to satisfy themselves as to their safe use and maintenance.

£2,000-3,000**145. Myca's (Bai Ling) Special Effects Head M****THE CROW (1994)**

Myca's (Bai Ling) special effects head used in the Alex Proyas fantasy thriller *The Crow*. Although never mentioned by name, the half-sister and lover of Mob boss Top Dollar (Michael Wincott) coveted Eric Draven's (Brandon Lee) crow and the invincible powers she expected to acquire along with it. This head was used during the closing scenes, in a gruesome sequence where the crow used its talons to rend Myca's face and gouge out her eyes.

The realistically detailed head has hand-punched hair, rubber skin painted to match Myca's skin tone and distinctive makeup, and even wears the red leather hood worn by the character throughout much of the movie. The corner of the right eye is scratched and bloody, as required for filming. There is a small hole located at the corner of the eye fed by a tube accessed from the neck. This tube delivered the blood for that horrific moment.

The face is marked through production use and repeated cleaning of stage blood from the slightly porous surface. However, it is still in very good condition for its age and is still incredibly supple. The head is presented on a custom-built stand that incorporates the film's title artwork and brief description, both illuminated using ultra-bright LEDs operated via a push button at the rear. To ensure maximum versatility, the head sits atop a chrome rod and is fixed to it with thick, posable wire, allowing it to be positioned in wide variety of angles.

Dimensions (displayed): 21 cm x 16 cm x 43 cm (17" x 8 1/2" x 6 1/2")

As this item contains electronic components, every effort has been made to describe them accurately. However, no guarantee or warranty is made as to functionality, lifespan or safety of those components. It is entirely incumbent on the new owner to satisfy themselves as to their safe use and maintenance.

£2,000-3,000



146. The Crow's (Brandon Lee) Costume Ω

THE CROW (1994)

The Crow's (Brandon Lee) costume from Alex Proyas' supernatural crime film *The Crow*. Starring Brandon Lee in his final role, the movie followed Eric, a murdered musician who returned from the grave as the Crow to seek revenge against the criminals who killed him and his fiancée.

The Crow's costume includes a black leather trench coat, a spandex shirt, a pair of leather trousers, and a pair of replica boots and replica electrical tape bandages for display purposes. Worn open, the double-breasted trench coat is made of black leather and includes a belt that is tied behind the back. The mid-length long-sleeve shirt is made of spandex and has a stirrup stitched to the bottom to anchor the shirt within the trousers. The electrical tape waist bandage is made of layers of electrical tape over nylon material, and includes strips of Velcro at the ends to secure it in place. The trousers are also made of leather and feature a button-up fly and stirrups at the heels. Showing minor wear due to production use, the costume remains in very fine condition.

£20,000-25,000



Moviestore Collection/REX/Shutterstock



147. Cable-Controlled Crow Puppet Ω

THE CROW (1994)

A cable-controlled crow puppet from Alex Proyas' supernatural crime film *The Crow*. Starring Brandon Lee in his final role, the movie followed Eric, a murdered musician who returned from the grave as the Crow to seek revenge against the criminals who killed him and his fiancée. The crow guided Eric once he returned to the world of the living, and blinded Myca (Bai Ling) during the finale in the cathedral.

The crow's beak and legs are made of resin, its eyes are acrylic and it has layered black feathers over fabric covering its body. It has cable controls protruding from under its tail, which previously controlled the movement of its wings and head.

Mounted to a display base in the shape of a gravestone, the crow shows some wear to the feathers, which are dishevelled due to production use and age, a few having fallen from the puppet. However, the lot remains in very fine condition.

Dimensions (puppet): 86.5 cm x 40.5 cm x 45.5 cm (34" x 16" x 18");
(displayed): 86.5 cm x 40.5 cm x 67.5 cm (34" x 16" x 26 ½")

£6,000-8,000

148. John McClane's (Bruce Willis) Radio †Δ

DIE HARD (1988)

John McClane's (Bruce Willis) radio from John McTiernan's 1988 action thriller *Die Hard*. McClane used his radio throughout the Nakatomi Plaza siege to infuriate Hans Gruber (Alan Rickman) and maintain contact with LAPD cop Al Powell (Reginald VelJohnson).

The piece is a real Kenwood TH-21BT walkie talkie, made with a plastic body, buttons and screw-on aerial. The radio's detachable battery is still present, and there is a hand-cut white label with the Kenwood logo on the back, along with a distinctive black line – only seen on McClane's radio – running along the bottom. It has numerous scratches on the plastic body and along the aerial from use, and is supplied with a letter of authenticity from the film's assistant property master. Dimensions: 3.5 cm x 6.5 cm x 18.5 cm (1 ½" x 2 ¾" x 7 ¼")

As this item contains electronic components, every effort has been made to describe them accurately. However, no guarantee or warranty is made as to functionality, lifespan or safety of those components. It is entirely incumbent on the new owner to satisfy themselves as to their safe use and maintenance.

£3,000-5,000



149. John McClane's (Bruce Willis) Watch †Δ

DIE HARD (1988)

John McClane's (Bruce Willis) chronograph watch from John McTiernan's action thriller *Die Hard*. McClane wore his analogue TAG Heuer watch turned inwards on his right wrist throughout the movie as he battled Hans Gruber's (Alan Rickman) terrorist gang at Nakatomi Plaza in Los Angeles.

Made from stainless steel with a glass (crystal) cover, the timepiece features three dials on the right and depth markings up to 50 m around its circumference. Its hour and minute hands are stopped at 10:10. The watch carries TAG Heuer trademarks on the reverse and is attached to a slim grey leather strap with a metal buckle. The watch shows scratching, marks and slight rust from ageing. The strap is significantly worn from age, displaying cracks and a strip torn off one side. Dimensions: 10 cm x 5 cm x 3 cm (4" x 2" x 1 ¼")

£3,000-5,000



150. John McClane's (Bruce Willis) Stunt Beretta and "Seasons Greetings" Tape †Δ

DIE HARD (1988)

John McClane's (Bruce Willis) Beretta sidearm and "Seasons Greetings" tape from John McTiernan's action thriller *Die Hard*. New York cop McClane wielded his trusty Beretta M92F throughout the film as he battled the band of terrorists in Nakatomi Plaza, using a strip of Christmas-themed tape to secure the weapon to his back for his final showdown with Hans Gruber (Alan Rickman).

This stunt version of McClane's sidearm was used for scenes in which a live-firing pistol was not required. Made of rubber, it is intricately cast, with full production markings and the serial number C63121Z present on the frame and slide. The tape features a repeating design, with the text "Season's Greetings" in red gothic font, accented by sprigs of holly. There is some damage to the tape, with minor

scratches and casting defects present on the pistol. The set is supplied with a letter of authenticity from property master Tommy Tomlinson.

Dimensions (pistol): 18 cm x 5 cm x 12 cm (7" x 2" x 4 ¾")

Please note, ownership of this item is restricted for U.K. residents to registered re-enactors, galleries or individuals in film, television or theatre production. Please enquire for further details. It is solely the buyer's responsibility to check, prior to bidding, the legal status of this prop within their own country and the importation therein.

£2,000-3,000



151. John McClane's (Bruce Willis) C-4 Plastic Explosive †Δ

DIE HARD (1988)

A block of C-4 plastic explosive from John McTiernan's action thriller *Die Hard*. C-4 explosive was carried by the terrorists led by Hans Gruber (Alan Rickman), with John McClane (Bruce Willis) using some stolen explosive to thwart the rocket attacks they launched against the LAPD's armoured car.

Placement of three of the detonators and marks on the label screen match the block used by McClane in the scene. The block of faux-plastic explosive is made of white Plasticine, wrapped in wax paper with a paper C-4 label on the top.

The label has been purposely distressed, with torn sections on the right-hand side. Stabbed through the label are five artificial detonators, one of which is wired to a circuit board. Holes are present in the sides and bottom, where other detonators have been pushed into the Plasticine. The piece is supplied with a letter of authenticity from property master Tommy Tomlinson. Dimensions: 5 cm x 18 cm x 12 cm (2" x 7" x 4 ¾")

£2,000-3,000

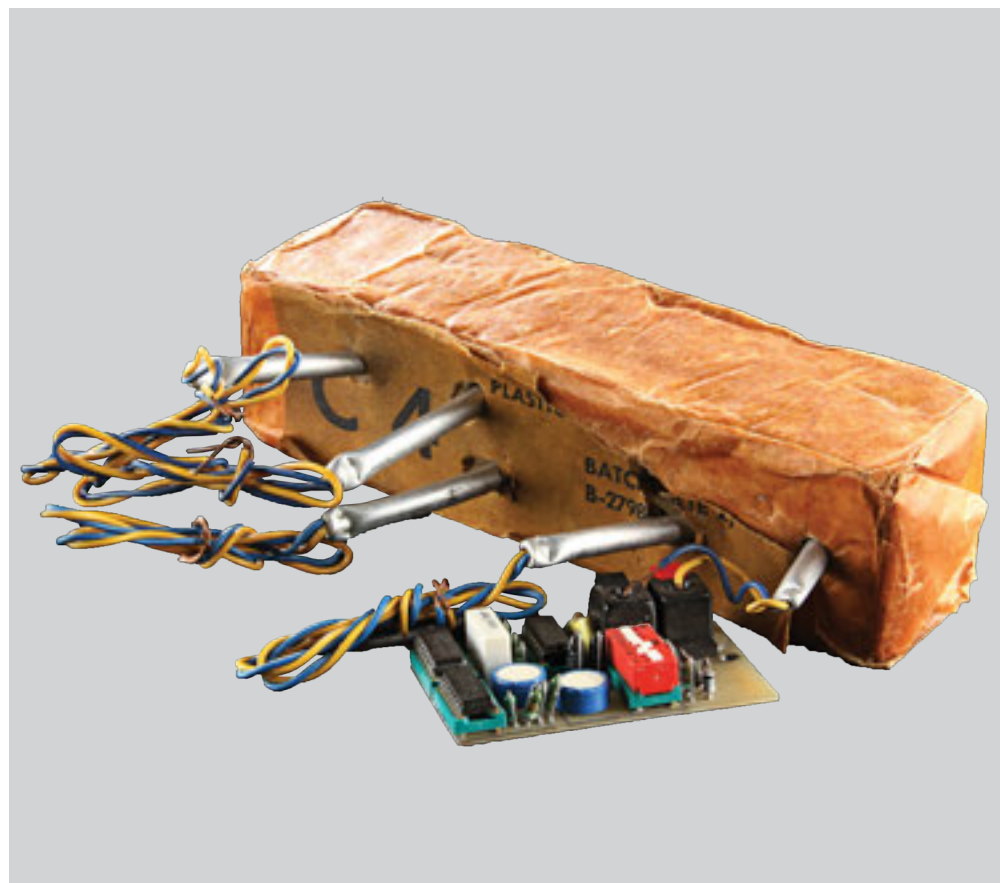

152. John McClane's (Bruce Willis) Costume Ω

DIE HARD 2 (1990)

John McClane's (Bruce Willis) costume from Renny Harlin's action sequel *Die Hard 2*. Once again finding himself in the wrong place at the wrong time, John McClane wore his plaid shirt and corduroy slacks throughout the terrorist attack on Dulles International Airport.

John's long-sleeve button-up shirt is made by Banana Republic and features a blue-and-green plaid pattern throughout. The corduroy slacks are grey with brown lining, and feature a zip fly with a hook-and-bar closure. The costume exhibits minor wear due to production use, but remains in very fine condition.

£6,000-8,000



153. 'A' Camera Clapperboard †Δ

A GOOD DAY TO DIE HARD (2013)

A clapperboard from John Moore's action thriller *A Good Day to Die Hard*. Used by the 'A' camera unit during filming, the clapperboard consists of an acrylic slate with a wooden clapper fixed on the top and the production title "A Good Day To Die Hard" printed in black and red. The names of director John Moore and Director of Photography Jonathan Sela are printed below. The last date it was used is marked 5 July 2012, written in black ink. Additional fields still feature details written in black. The clapper shows minor wear from use on production, including scuff marks and scratches to the paint on the clapper arm. Dimensions: 4 cm x 28 cm x 24 cm (1 1/2" x 9 1/2" x 1 3/4")

£800-1,200



154. Production-Used Autographed Clapperboard M

DOCTOR WHO (TV SERIES 2005)

An autographed clapperboard from the long-running British sci-fi TV series *Doctor Who*. The clapperboard is made of white acrylic, with a black clapstick painted with white lines, hinged on the right edge with metal fixings.

The show title and series are etched across the top of the board, with boxes below for information regarding roll, slate, take, director, DOP and date, as well as options for "int/ext" and "day/night". "VFX" and the letter "B" are also engraved, denoting its use on visual-effects shots by the B camera.

The board is autographed by 11th Doctor Matt Smith, with the dedication "Stay Cool!" It is also autographed by Karen Gillan, Alex Kingston, Mike Skinner and Simon Dutton. "Adam Smith" (Director), "Damian Bromley" (DOP) and the date "19th August 2009" are handwritten in black marker, suggesting this was used on the episode 'The Time of Angels'.

Dimensions: 3cm x 28 cm x 23 cm (1" x 11" x 9")

£2,000-3,000



155. Pair of Mooby Corporation Door Handles Ω

DOGMA (1999)

A pair of Mooby Corporation door handles from Kevin Smith's religious satire *Dogma*. Mooby door handles were spattered with blood when rogue angels Bartleby (Ben Affleck) and Loki (Matt Damon) went to the Mooby Corporation Headquarters and killed the board for their many sins.

Made of metal and finished in faux-gold paint, the door handles are fashioned to depict Mooby the cow's snout. The back of each handle is also labeled for either the right or left side of the doors. The handles are distressed with stage blood from production, but remain in very fine condition.

Dimensions: 24 cm x 28 cm x 1 cm (9 1/2" x 11" x 1/2")

£300-500

156. Chainsaw M

DOOM (2005)

A chainsaw from Andrzej Bartkowiak's action-horror video-game adaptation *Doom*. Chainsaws were seen on the wall of the Olduvai mines, with John Grimm (Karl Urban) taking the weapon to kill the demonic Pinky (Dexter Fletcher).

This heavy resin and fibreglass chainsaw features a large grip to the right of the engine, with a second mounted over the top — both are secured with metal bolts. On the left is a rip cord that can be pulled, but is inactive. The resin guard mounted over the blade features two protruding knife-like blades. The main blade is made of resin, featuring two chains of serrated teeth and chunky mechanical details.

Intentionally distressed for production, the saw is painted to resemble worn metal, and the blades' steely grey fade and metallic hues create a futuristic look. The saw shows minor production-based wear, and two of the teeth are damaged. Dimensions: 110 cm x 42.5 cm x 32 cm (43 1/4" x 16 3/4" x 12 1/2")

£2,000-3,000



157. The Grinch (Jim Carrey) Make-up Test Bust Ω

DR. SEUSS' HOW THE GRINCH STOLE CHRISTMAS (2000)

A Grinch (Jim Carrey) make-up test bust from Ron Howard's live-action adaptation of *Dr. Seuss' How the Grinch Stole Christmas*. This pre-production bust was created during early tests, and was designed by legendary make-up artist Rick Baker.

Created on a rigid foam head cast of Jim Carrey, this hairless test piece features foam-latex appliances that are glued down, blended and painted just as they would be if applied to an actor. The facial appliances are fully painted in the character's trademark green skin colour, and the elongated snout reflects Dr. Seuss' signature aesthetic. The bust is held to a plywood base via two nylon straps that are screwed in place. The foam skin remains soft, with only minor surface wear to the paint, and is in very fine condition.

Dimensions (on base): 44.5 cm x 44.5 cm x 44.5 cm (17 1/2" x 17 1/2" x 17 1/2")

£1,000-1,500



158. Gene Colan and Tom Palmer Hand-Drawn Page One Title Splash Artwork Ω

DRACULA / THE TOMB OF DRACULA #61 (1977)

Hand-drawn page one title splash artwork by Gene Colan and Tom Palmer featuring Dracula for Tomb of Dracula #61. In this issue, Dracula attempted to prevent his love Domini from initiating a summoning ritual which would bring back their dead son, Janus.

This original pencilled-and-inked artwork is drawn on Bristol board by penciller Gene Colan and inker Tom Palmer. The splash page shows Dracula pondering if he should return to Domini. The title art is pasted to the top of the sheet, while an indicia with publishing information is pasted to the bottom. Handwritten at the top of the sheet is "Tomb of Dracula" and "61". The piece is signed by Gene Colan in blue ink. On the back of the artwork is a Marvel Comics Group stamp.

Included with the lot is a reference copy of Tomb of Dracula #61, the comic book in which this art was originally published. The artwork shows tape residue and minor staining to the front and back, but remains in very good condition.

Dimensions: 40 cm x 27 cm (15 3/4" x 10 1/2")

Please note this lot is sold without copyright, reproduction rights, licencing agreements or any other type of legal release.

£1,800-2,200



159. Judge Chan's (Karl Thaning) Complete Costume Ω

DREDD (2012)

Judge Chan's (Karl Thaning) complete Street Judge costume from Pete Travis' dystopian action thriller *Dredd*. The corrupt Judge wore his costume when he arrived at the Peach Trees block with fellow Judges Lex (Langley Kirkwood), Alvarez (Edwin Perry) and Kaplan (Michele Levin). All had been ordered by gang boss Ma-Ma (Lena Heady) to dispose of Judge Dredd (Karl Urban) and the rookie Anderson (Olivia Thirlby) before they could expose her drug operation.

Based on the original design from the 2000AD comics, this costume comprises upper body armour (marked "Stunt"), which bears the Judge's name badge on the left chest, with a black leather jacket (marked "Stunt Hirst" for Chan's stunt double, Dan Hirst) and trousers (marked "Stunt D Hirst"), both of which have ribbed green leather elbow and knee pads. It also includes a pair of black leather gloves (marked "Chan Stunt"), heavy black leather size 9 biker boots (marked "Chan Stunt") with plastic decorative panels, and a utility belt featuring a brass-effect Department of Justice eagle emblem buckle, a stunt folded knife, plasti-cuffs, a hero double Lawgiver ammo holster (empty) and stunt holster (full), and green leather pockets containing a smoke grenade, mine and flash-bang spheres.

Completing this impressive ensemble is an unnamed Judge helmet. The fibreglass helmet is decorated with the iconic black-and-burgundy colours of a Judge's uniform, with a dark-tinted visor to the front. It has been intentionally distressed with battle scratches covering the surface, bearing witness to years of heavy use in Mega-City One. There is full padding inside for comfort. The entire costume remains in good production-distressed condition.

£10,000-15,000



160. Edward Scissorhands' (Johnny Depp) Costume Display Ω

EDWARD SCISSORHANDS (1990)

An Edward Scissorhands (Johnny Depp) costume display from Tim Burton's beloved dark fantasy film *Edward Scissorhands*. Created by a visionary inventor (Vincent Price), young Edward Scissorhands was swept from isolation and brought into suburbia where his odd personality and appearance became the talk of the town. The film was a defining moment in director Tim Burton's career, wowing audiences with its powerful imagery. Designed by Tim Burton and costume designer Colleen Atwood, the costume was made by Western Costume. It was previously on display at Stan Winston Studio as part of Stan Winston's personal collection, and also appeared in the Tim Burton Exhibition at the MoMA in New York between 2009 and 2010. The head was created by Stan Winston Studio based on a Johnny Depp lifecast for display.

The costume is made of leather and vinyl material that is gothic in style, in stark contrast to the supporting cast's bright 1950's-inspired costume design. As Edward was an inventor's work in progress, his suit is intentionally assembled with uneven cuts to the fabric, large visible stitches, rows of safety pins and buckled straps throughout.

Edward's scissor-hands consist of flexible urethane over black spandex, and have cast resin blades on each finger, with a single urethane blade on the left hand.

The gloves include decorative resin pistons that are bolted in place and buckled leather straps at the wrists. Authentic examples of original scissor-hands are exceedingly rare.

Most of the costume consists of original production components, with a few pieces recast by Stan Winston Studio for display purposes, such as the moon-shaped belt buckle. The shirt and pants both feature Western Costume wardrobe labels inside that read "DEPP DOUB", while the boots feature "Stunt" handwritten inside. The costume is missing a few components, such as original neck collars, its right shoulder and bicep cover, its waist belt and its left hip cover.

The costume features a Johnny Depp lifecast and is mounted to a bespoke foam mannequin with a wooden base. The crotch-piece is notably attached to the costume, albeit backwards. One arm is broken near the shoulder, and while it is still firmly attached the arm now rests crooked. Edward's costume exhibits wear due to production use and age, with the gloves showing light deterioration to the materials. However, it remains in fine overall condition. Dimensions (displayed): 145 cm x 66 cm x 175 cm (57" x 26" x 69")

£60,000-80,000



Moviestore Collection/REX/Shutterstock

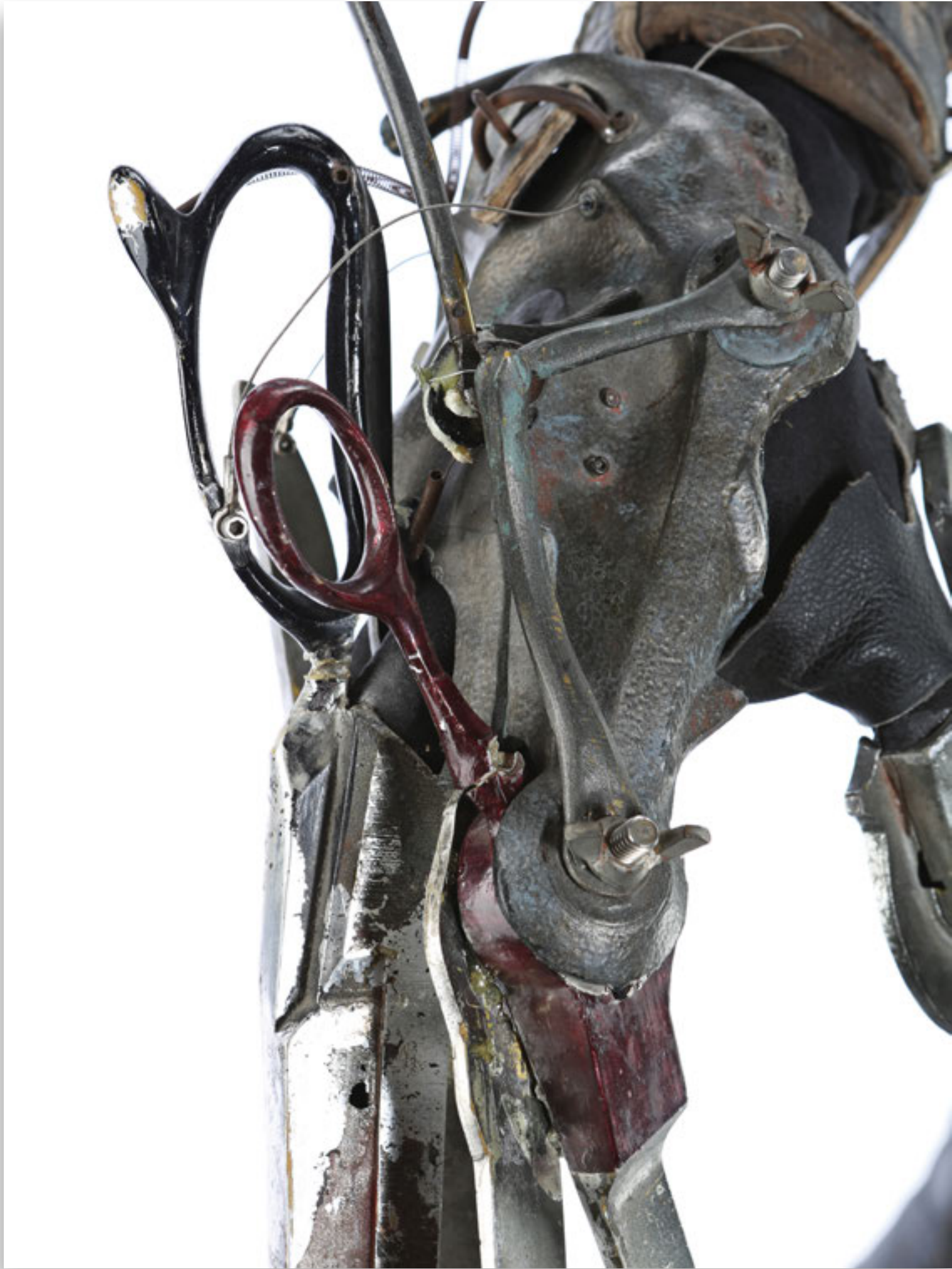

161. Monsieur de Foix's (Eric Cantona) Livery Chain M**ELIZABETH (1998)**

Monsieur de Foix's (Eric Cantona) livery chain from Shekhar Kapur's historical drama *Elizabeth*. De Foix wore his chain throughout the film as he attempted to negotiate a marriage between Elizabeth I (Cate Blanchett) and Duc d'Anjou (Vincent Cassel).

The chain is made of aluminium that is coated to appear like gold, with a circular pendant cast with an elaborate floral pattern. The pendant is attached to the chain via a length of purple-and-black satin fabric. The fabric displays light fraying, and the chain remains in very good condition. Dimensions (chain length): 92 cm (36 1/4"); (pendant): 9 cm x 7 cm x 0.5 cm (3 3/4" x 2 3/4" x 1/4")

£400-600**162. Elizabeth I's (Cate Blanchett) Orb and Sceptre M****ELIZABETH (1998)**

Elizabeth I's (Cate Blanchett) orb and sceptre from Shekhar Kapur's historical drama *Elizabeth*. Elizabeth held the monarchical symbols of power during her coronation ceremony as she became Queen of a divided England. The famous portrait "The Coronation of Elizabeth" was used as the basis for designing the props and costume for the ceremonial scene in the film.

The orb is made from metal with faux-gold banding and is heavily decorated with pearl-like beads and gems made of red and green plastic. Finished in a deep grey,

a cross shape is affixed to the top with matching decoration. The gold-plated metal sceptre is adorned with embossed filigree-inspired patterns, with matching pearls and decorative gem decoration. The lot shows signs of wear from production use, including minor scratches to the sceptre, signs of corrosion on the orb and paint wear. Dimensions (orb): 19 cm x 19 cm x 30 cm (7 1/2" x 7 1/2" x 12"); (sceptre): 76 cm x 4.5 cm x 4 cm (30" x 1 3/4" x 1 3/4")

£3,000-5,000**163. Delacourt's (Jodie Foster) Costume M****ELYSIUM (2013)**

Delacourt's (Jodie Foster) costume from Neill Blomkamp's sci-fi adventure *Elysium*. Delacourt wore her bloodied suit towards the end of the film when she was fatally stabbed in the neck by Agent Kruger (Sharlto Copley).

Delacourt's costume consists of a grey two-piece Armani suit; a sleeveless grey, silk-like cowl neck top; a pair of Guess patent black heels; and a personalised Elysium ID. The number "4" is written on the label inside the jacket neckline and the shoes are a size 7 1/2. The suit and top are heavily distressed with stage blood for the production. The costume is accompanied by three handwritten production wardrobe tags and a Media Rights Capital certificate of authenticity.

£800-1,200**164. Cooper's (Richard T. Jones) Spacesuit M****EVENT HORIZON (1997)**

Cooper's (Richard T. Jones) spacesuit from Paul W.S. Anderson's sci-fi horror film *Event Horizon*. Cooper wore his spacesuit as he and Smith (Sean Pertwee) repaired the damaged Lewis And Clark spaceship, before an explosion cast him off into space. Cooper had to rapidly expel the air from his spacesuit, using a "purge" device, to return to the Event Horizon.

This detailed costume was custom-made for the actor and consists of a helmet; a backpack with a built-in, working fan to keep the wearer cool during filming; a chest plate detailed with Cooper's name and suit number; a thick padded jacket with matching trousers, bearing yellow stripes used to identify Cooper during extra-vehicular operations; a pair of heavy duty boots; a pair of leather gloves; a leather belt; and leg and arm webbing.

The suit is covered in intricate light-up detailing inside and out. The helmet features pulsing respiratory lights and realistic gauges — a hidden switch inside sets the oxygen level to "urgent", causing the respiratory lights to go red. It is finished with two lights on either side to illuminate the darkest of corridors. The boots are fitted with lights that illuminate the ground in front, with pressure switches that allowed lights on the sole to light up green when a foot touched the ground and red when lifted, suggesting the presence of Zero-G boot magnets in the film.

Character name badges are sewn on the main costume, along with an EU patch on the left sleeve and a round yellow patch for "The Lewis And Clark Search And Rescue Ship" on the right. The purge control is attached to the centre of the chest plate. When the purge button is pressed the middle glows red, and the depression of another button on the side causes the radial markers to increase and decrease. This control device is unique to this suit.

Presented on a custom-made base featuring the film's title artwork illuminated with LEDs, and a floor plate to replicate the surface of the doomed vessel, the costume displays only minor wear, with the wiring for the display base set up such that the left boot is set to light up red (floating) and the right is disconnected. Dimensions: 215 cm x 85 cm x 70 cm (84 1/2" x 33 1/2" x 27 1/2")

As this item contains electronic components, every effort has been made to describe them accurately. However, no guarantee or warranty is made as to the functionality, lifespan or safety of those components. It is entirely incumbent on the new owner to satisfy themselves as to their safe use and maintenance.

£10,000-15,000

165. 'A' Camera Clapperboard M

EVIL DEAD 2 (1987)

A production-used 'A' camera clapperboard from Sam Raimi's cult horror-comedy *Evil Dead 2*. Made from white acrylic with wooden clapper sticks and metal hinges, it is embossed with 'Evil Dead II', with the names of Raimi and cinematographer Eugene Schlugleit – who was famously replaced after only two weeks of filming the production's exterior night sequences – printed in the 'Director' and 'Camera' fields.

The board is dated '6-2-86', indicating its use early on in production prior to Schlugleit's replacement, and marked with a large blue 'A' on the far right. Two autographs from members of the special effects crew are present in permanent marker ink. Presented in a custom wood and acrylic display case, scratches and masking tape residue appear across the clapperboard due to heavy production use. The case shows minor wear from storage. Dimensions: 43 cm x 37 cm x 5 cm (16 ¾" x 14 ½" x 2")

£600-800



166. Main Cast Autographed Poster M

FANTASTIC 4: RISE OF THE SILVER SURFER (2007)

An autographed US one-sheet poster (G condition) for Tim Story's superhero sequel *Fantastic 4: Rise of the Silver Surfer*. Backed onto black foam board, the poster is autographed in silver ink by the four lead actors: Ioan Gruffudd, Jessica Alba, Chris Evans and Michael Chiklis. There are minor creases and wear around the edges and corners, a small dent on the left edge, and a small circular mark on the top edge. Six squares of white adhesive tape are secured to the back of the board from its time on display. Dimensions: 102 cm x 68 cm x 0.5 cm (40" x 27" x ¼")

£200-300

167. Thing's (Michael Chiklis) Head-And-Torso Costume †Δ

FANTASTIC 4: RISE OF THE SILVER SURFER (2007)

Thing's (Michael Chiklis) head-and-torso costume from Tim Story's superhero sequel *Fantastic 4: Rise of the Silver Surfer*. Having transformed into the rocky being known as Thing, Ben Grimm worked with the super-team throughout the film as they confronted the alien Silver Surfer (Doug Jones) and attempted to save the Earth from his powerful, planet-consuming master Galactus.

Made from foam latex, the costume consists of separate appliances for the head, torso and hands. The components feature ridged, rock-shaped patterns with an orange paint finish that has a wash applied to darken the recesses. Each piece is fitted with press studs to secure them together.

The head has holes cut out for the eyes, nose and mouth and is labelled "#3" inside with blue ink. The torso is lined with black Lycra and has a zip running up the length of the back that is concealed behind a matching panel, as well as Velcro and elastic straps at the bottom to secure it around the actor's legs. The interior of the back panel shows a handwritten black marker label reading "#10 HERO."

The ensemble is presented on a custom-made display and base. Signs of production use are evident, including light paint wear throughout the suit, and it remains slightly sticky to the touch.

Dimensions (on display): 51 cm x 80 cm x 186 cm (20" x 31 ½" x 73")

£5,000-7,000



168. John Byrne and Terry Austin Hand-Drawn Page 23 Artwork Ω

FANTASTIC FOUR #286 (1986)

Hand-drawn page 23 artwork by John Byrne and Terry Austin featuring Mr. Fantastic, the Invisible Woman and Hercules, as they witness a flashback to an event from *Uncanny X-Men #100*, in which Jean Grey and Cyclops argue about Jean's plan to land the Starcore Shuttle, with Banshee, Colossus, Nightcrawler, Storm, Wolverine and Dr. Peter Corbeau present.

This original pencilled-and-inked artwork is drawn on Bristol board by penciller John Byrne and inker Terry Austin. This issue brought Jean Grey/Phoenix back from the dead, as she had been killed off six years earlier in *Uncanny X-Men #137*. "FANTASTIC FOUR" is stamped in the book field, with "286" written in marker in the issue field, and "23" written before the page-number field. Written on the side of the board is "DROP RED LINES!", "SURPRINT: 100% BLUE", and "REMOVE RED LINES".

Included with the lot is a reference copy of *Fantastic Four #286*, the comic book in which this art was originally published. White-out correction fluid is present, and three corners of the board are cut with scissors, but the artwork remains in very good condition. Dimensions: 28 cm x 42 cm (11" x 16 ½")

Please note this lot is sold without copyright, reproduction rights, licencing agreements or any other type of legal release.

£2,200-3,200



169. John Byrne and Terry Austin Hand-Drawn Unpublished Page 24 Artwork Ω

FANTASTIC FOUR #286 (1986)

Hand-drawn page 24 artwork by John Byrne and Terry Austin featuring Mr. Fantastic, the Invisible Woman and Hercules as they witness a previously undocumented flashback sequence explaining the origin of Phoenix. On this page it is revealed that the Phoenix entity took the place of Jean Grey prior to the shuttle crash from which Phoenix emerged in *Uncanny X-Men #101*. This version of the origin (written and pencilled by John Byrne) was never published. Although the first panel did make it into publication, Jackson "Butch" Guice re-drew the last five panels of the page and Chris Claremont wrote new dialogue for the published origin.

This original pencilled-and-inked artwork is drawn on Bristol board by penciller John Byrne and inker Terry Austin. This issue brought Jean Grey/Phoenix back from the dead, as Phoenix had been killed off six years earlier in *Uncanny X-Men #137*. Stamped over handwriting at the top of the sheet is "FANTASTIC FOUR" in the book field, with "286" written in marker in the issue field, and "24" written over the page-number field. Written at the top of the board is "TERRY — COLOR-HOLD SPACE AGAIN". Written on the back of the board is "100% NO OVERLAY Love Mikey" from editor Michael Carlin.

Included with the lot is a reference copy of *Fantastic Four #286*, the comic book in which the first panel was originally published. The board shows minor wear due to use and age, but remains in very good condition. Dimensions: 28 cm x 43 cm (11" x 17")

Please note this lot is sold without copyright, reproduction rights, licencing agreements or any other type of legal release.

£2,000-3,000



170. Edward Rooney's (Jeffrey Jones) Certificate of Appreciation and Plaque †Δ

FERRIS BUELLER'S DAY OFF (1986)

Edward Rooney's (Jeffrey Jones) framed certificate and plaque from John Hughes' comedy *Ferris Bueller's Day Off*. Principal Rooney's awards and certificates decorated his office walls, boasting his many academic achievements.

The framed award displays a printed certificate of appreciation, dedicated to Rooney, from "The Board of Supervisors" with a faux-gold seal on the left corner. It is presented in a metal frame with a cream card window matte. Accompanying the award is a metal plaque featuring faux-gold text on a black background, proclaiming Rooney as "Principal of the Year", mounted on wood. The awards show minor wear, including a stain on the certificate in the top left corner and surface scratches on the metal plaque.

Dimensions (certificate): 37 cm x 29 cm x 2 cm (14 1/2" x 11 1/2" x 3/4")

£600-800



171. J.M. Barrie's (Johnny Depp) Native American Headdress M

FINDING NEVERLAND (2004)

J.M. Barrie's (Johnny Depp) Native American headdress from Marc Forster's biographical fantasy drama *Finding Neverland*. Peter Pan playwright Barrie wore his headdress while entertaining Sylvia Llewelyn Davies' (Kate Winslet) family – a reflection of the Lost Boys' games with the Native Americans in the play.

The headdress consists of a rabbit-fur hat lined with suede and detailed with red, blue and white bead trimming across the headband. Three lengths of white fur hang from matted red fleece bound in twine on either side. Numerous brown-and-white feathers are secured at the back, with lengths of red synthetic hair trailing out behind. Each feather ends with a small piece of fur. Additionally, four small bells are adhered to the front of the headband. The headdress shows light wear from production use.

Dimensions: 35 cm x 40 cm x 60 cm (13 3/4" x 15 3/4" x 23 1/2")

£3,000-5,000



172. Tyler Durden's (Brad Pitt) Robe Ω

FIGHT CLUB (1999)

Tyler Durden's (Brad Pitt) robe from David Fincher's *Fight Club*. The chaotic soap-maker Tyler frequently wore his robe around the decrepit house he shared with the film's narrator (Edward Norton).

This robe is produced by Canyon Group and is made from plush chenille material. Various colourful coffee mugs are embroidered throughout the robe, as befits Tyler's eclectic aesthetic. The robe fastens with a tie around the waist, is marked as size extra large and displays intentional wear, including various stains. Accompanying the lot is a certificate of authenticity from 20th Century Fox.

£10,000-15,000



173. Carmine Infantino and Joe Giella Page 1 Title Splash Artwork Ω

THE FLASH #129 (1962)

Hand-drawn page one title splash artwork by Carmine Infantino and Joe Giella featuring the Silver Age and Golden Age versions of the Flash (Barry Allen and Jay Garrick), as they face off against Captain Cold and Trickster in The Flash #129. This issue marked the second appearance of the Golden Age Flash in the Silver Age and was an early story that featured heroes crossing over from Earth-2.

This original pencilled-and-inked artwork is drawn on Bristol board by penciller Carmine Infantino and inker Joe Giella. The page shows the Flashes jumping back as they are attacked by Captain Cold and Trickster, who introduce each other in speech balloons. At the top of the board is the title art, along with two speech balloons discussing the Flash team up, and a third balloon that reads "DOUBLE DANGER ON EARTH". The piece is autographed at the bottom by the editor in black ink and reads, "Julius Schwartz 1997".

Included with the lot is a reference copy of The Flash #129, the comic book in which this art was originally published. The comic book has been autographed on the cover by inker, Joe Giella. Some white-out correction fluid is present, and the piece has been professionally cleaned to remove a stain below Trickster, but the artwork remains in very fine condition. Dimensions: 35.5 cm x 54 cm (14" x 21 1/4")

Please note this lot is sold without copyright, reproduction rights, licencing agreements or any other type of legal release.

£45,000-50,000

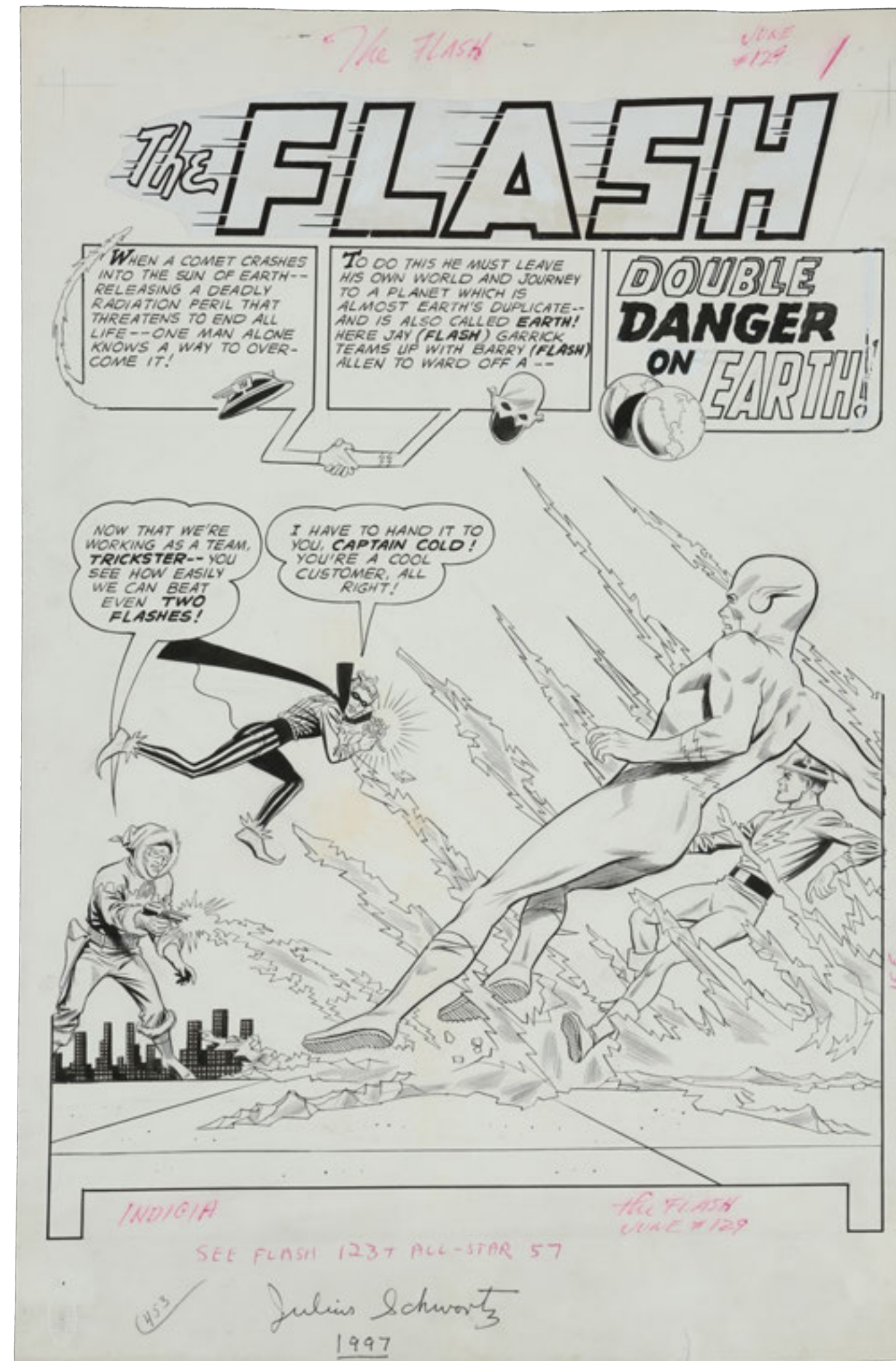

174. Forrest Gump's (Tom Hanks) Weathered Bubba Gump Shrimp Hat Ω

FORREST GUMP (1994)

Forrest Gump's (Tom Hanks) weathered Bubba Gump Shrimp hat from Robert Zemeckis' Academy Award®-winning drama *Forrest Gump*. Forrest Gump (Tom Hanks) started a shrimping company with his friend Lieutenant Dan (Gary Sinise). Later, Forrest wore a Bubba Gump hat that began to show wear as he embarked on a seemingly endless cross-America run.

This red hat is adjusted via a snapping strap at the back. The front of the hat displays an embroidered Bubba Gump Shrimp Company logo. The outside of the hat features intentional weathering to reveal the effect of Forrest's rigorous cross-country trek. Showing obvious wear from production, this piece is in very fine condition. Dimensions: 25.5 cm x 18 cm x 13 cm (10" x 7" x 5")

£5,000-7,000



175. Forrest Gump's (Tom Hanks) Feather and Pair of Continuity Photographs Ω

FORREST GUMP (1994)

Forrest Gump's (Tom Hanks) feather and a pair of continuity photographs from Robert Zemeckis' Academy Award®-winning drama *Forrest Gump*. During the film's opening scene, a feather fell at Forrest's feet. Though a computer-animated feather was created for shots showing motion, a real feather was placed by Forrest's feet for him to interact with. This feather screen-matches to the one held by Forrest on the park bench.

This real feather is white with grey markings. It is accompanied by two continuity Polaroid photographs. One displays the feather at Tom Hanks' feet, while the other displays Hanks sitting on the film's famous park bench. Each photograph is labeled, with "1" and "4" respectively. The lot shows some signs of wear to the continuity photographs from use and storage, but is in fine overall condition.

Dimensions (feather): 10 cm x 5 cm (4" x 2")

£5,000-7,000

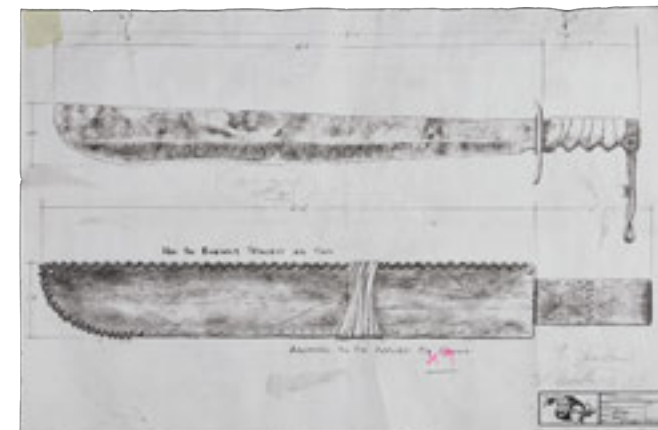

176. Jason Vorhees' (Ken Kirzinger) Machete Printed Drawing Ω

FREDDY VS. JASON (2003)

A printed drawing depicting Jason Vorhees' (Ken Kirzinger) machete from Ronny Yu's horror mash-up *Freddy Vs. Jason*. Designed by production designer John Willett, the rendering shows Jason's signature weapon, along with an accompanying sheath.

Drawn to a 1-1 scale, the illustration shows the two-and-a-half foot-long machete with handwritten annotation around the sheath. The drawing shows wrinkles to the paper and dirt on the reverse side; however, it remains in fair rolled condition. Dimensions: 86 cm x 56 cm (34" x 22")

Please note this lot is sold without copyright, reproduction rights, licensing agreements or any other type of legal releases.

£800-1,000



177. Freddy Krueger (Robert Englund) Finger Blades and Prototype Glove Components Ω

FREDDY VS. JASON (2003)

Freddy Krueger (Robert Englund) finger blades and prototype glove components made for Ronny Yu's horror mash-up *Freddy Vs. Jason*. This lot consists of finger blades from the film, a prototype finger blade with a ring, and a backplate. Freddy's gloves were constructed with interchangeable blades, which allowed the production to swap out metal claws for resin ones for stunt sequences.

Of the two blades from the film, one is made of aluminium, while the other is made of resin painted metallic silver in colour. The prototype razor is made of resin and is fixed to an unfinished fingertip. The last component is an unpainted resin backplate, which would have been bolted to the back of Freddy's glove. The lot shows minor wear due to production use, but remains in fine condition. Dimensions: 22 cm x 10 cm x 4 cm (8 1/2" x 4" x 1 1/2")

£1,000-1,500



178. Freddy Krueger's (Robert Englund) Test-Fitting Glove Ω

FREDDY VS. JASON (2003)

Freddy Krueger's (Robert Englund) test-fitting glove from Ronny Yu's horror mash-up *Freddy Vs. Jason*. This glove was made as a test piece for Robert Englund for sizing purposes.

The metal fingers show lines drawn in black marker, where Englund noted his knuckles for sizing. The test glove shows markings from the production and is in very good condition. Dimensions: 21 cm x 38 cm x 5 cm (8 1/4" x 15" x 2")

The work glove is made of leather, with the palm trimmed away. Bolted to the top of the glove is a copper armature, which has metal claws welded to each fingertip.

£4,000-6,000



179. Freddy Krueger's (Robert Englund) Razor Glove Ω

FREDDY VS. JASON (2003)

Freddy Krueger's (Robert Englund) razor glove from Ronny Yu's horror mash-up *Freddy Vs. Jason*. Freddy used his signature razor claws throughout the film as he hunted teenagers, while also facing off against the masked killer Jason Vorhees (Ken Kirzinger). The glove is made of leather with a copper plate bolted to the top, and has metal claws attached to four armatured fingertips. The metal claws were created for a sequence that was ultimately cut from the final film. Both the glove and the copper are distressed by the production to appear worn. Accompanying the glove is a letter of authenticity attributing the item to special effects coordinator Wayne Beauchamp. The glove is in very fine condition.

Dimensions: 37 cm x 27 cm x 6 cm (14 ¾" x 10 ½" x 2 ½")

£15,000-25,000



180. Freddy Krueger's (Robert Englund) Finger Blade Ω

FREDDY VS. JASON (2003)

Freddy Krueger's (Robert Englund) finger blade from Ronny Yu's horror mash-up *Freddy Vs. Jason*. Freddy used his claws to tear off Kia's (Kelly Rowland) nose during a nightmare.

The piece is made of metal, with the blade welded to the fingertip. Rather than a pointed tip, the blade has a flat, dulled end for safety purposes. The finger blade shows intentional production distressing to appear aged, but remains in very fine condition.

Dimensions: 18 cm x 3 cm x 4 cm (7" x 1" x 1 1/2")

£2,000-3,000



181. Jason Voorhees' (Ken Kirzinger) Machete Ω

FREDDY VS. JASON (2003)

Jason Voorhees' (Ken Kirzinger) machete from Ronny Yu's horror mash-up *Freddy Vs. Jason*. Designed by production designer John Willett, this version of Jason's signature weapon is made in 3/4 scale for specialised shots to make Jason appear larger.

The prop weapon features a dull aluminium blade with a tape-wrapped wooden handle. Both the blade and the grip are distressed by the production to appear

aged and dirty. The machete shows minor wear due to production use, and is in very fine condition.

Dimensions: 62 cm x 11 cm x 3 cm (24 1/4" x 4 1/2" x 1")

£2,000-3,000



182. Production Script, Paperwork and Call Sheets M

FULL METAL JACKET (1987)

A collection of paperwork from Stanley Kubrick's Oscar®-nominated Vietnam War film *Full Metal Jacket*. This paperwork comes from the production manager Philip Kohler's estate and features his personal annotations. The script is bound in a brown ring-binder folder and consists of 197 printed A4 pages, including blue, yellow and pink-coloured revisions.

Accompanying it are two more ring-binder folders and a stack of loose paperwork filled with various cast lists, call sheets, and shooting and location schedules and breakdowns. Well-used, the paperwork shows edgewear and creases throughout, with some minor corrosion around metal staples. Dimensions (largest folder): 32 cm x 29 cm x 8 cm (12 1/2" x 11 1/2" x 3 1/4")

£600-800

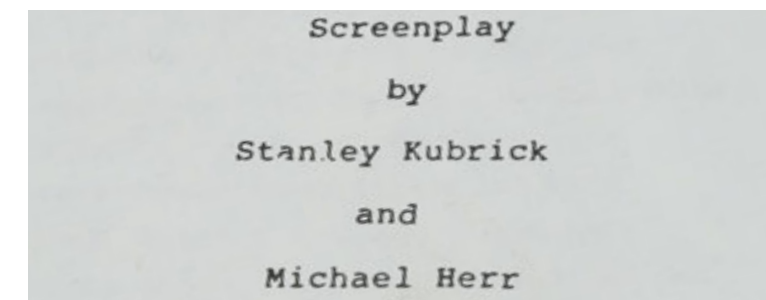
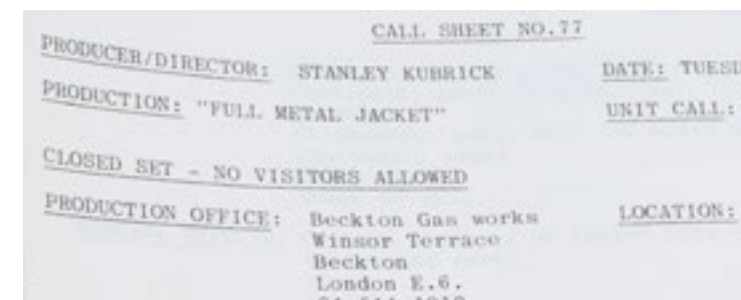

183. U.S. Marine M16 Rifle †Δ

FULL METAL JACKET (1987)

A prop M16 rifle from Stanley Kubrick's Oscar®-nominated Vietnam War film *Full Metal Jacket*. M16s were carried by the U.S. Marines during Pvt. Joker's (Matthew Modine) deployment to Vietnam as a Stars and Stripes war correspondent.

The use of replica Model Gun Company (MGC) cap guns as background weapons during production is well documented, with the rifles easily identified on-screen by the solid-cast forward assist on the right-hand side of the receiver.

The weapon is made of metal with black ABS plastic grips, a plastic buttstock, a green canvas sling and an original Colt 20-round magazine. Designed to operate like a real M16, it has a working charging handle, safety and trigger.

Metal components have a blued steel finish. Some corrosion and wear is present from use and time spent in storage.

Dimensions: 98 cm x 7 cm x 24 cm (38 3/4" x 2 3/4" x 9 3/4")

Ownership of this item is restricted for UK residents to those registered as re-enactors, galleries, or individuals in film, television or theatre production. Please enquire for further details. It is solely the buyer's responsibility to check, prior to bidding, the legal status of this prop within their own country and its importation therein.

£400-600



184. Frank Springer Hand-Drawn Cover Artwork Ω

G.I. JOE: A REAL AMERICAN HERO #32 (1985)

Hand-drawn cover artwork by Frank Springer featuring Zartan and the Dreadnoks for issue #32 of *G.I. Joe: A Real American Hero*. The cover shows the classic villain Zartan front and centre on a motorcycle, with the Dreadnoks biker gang riding behind him.

This original cover artwork was pencilled and inked by Frank Springer and drawn on Bristol board. The title art and Marvel issue block are pasted on. On the back of the artwork is a Marvel Comics Group stamp. Early G.I. Joe cover artwork is extremely scarce and rarely comes to market. This cover was purchased directly from the artist's collection and has never been offered publicly before.

Included with the lot is a reference copy of *G.I. Joe: A Real American Hero* #32, the comic book in which this art was originally published. The artwork shows scratches to the board with minor tanning, but remains in fine condition.

Dimensions: 43 cm x 28 cm (17" x 11")

Please note this lot is sold without copyright, reproduction rights, licencing agreements or any other type of legal release.

£4,000-4,500

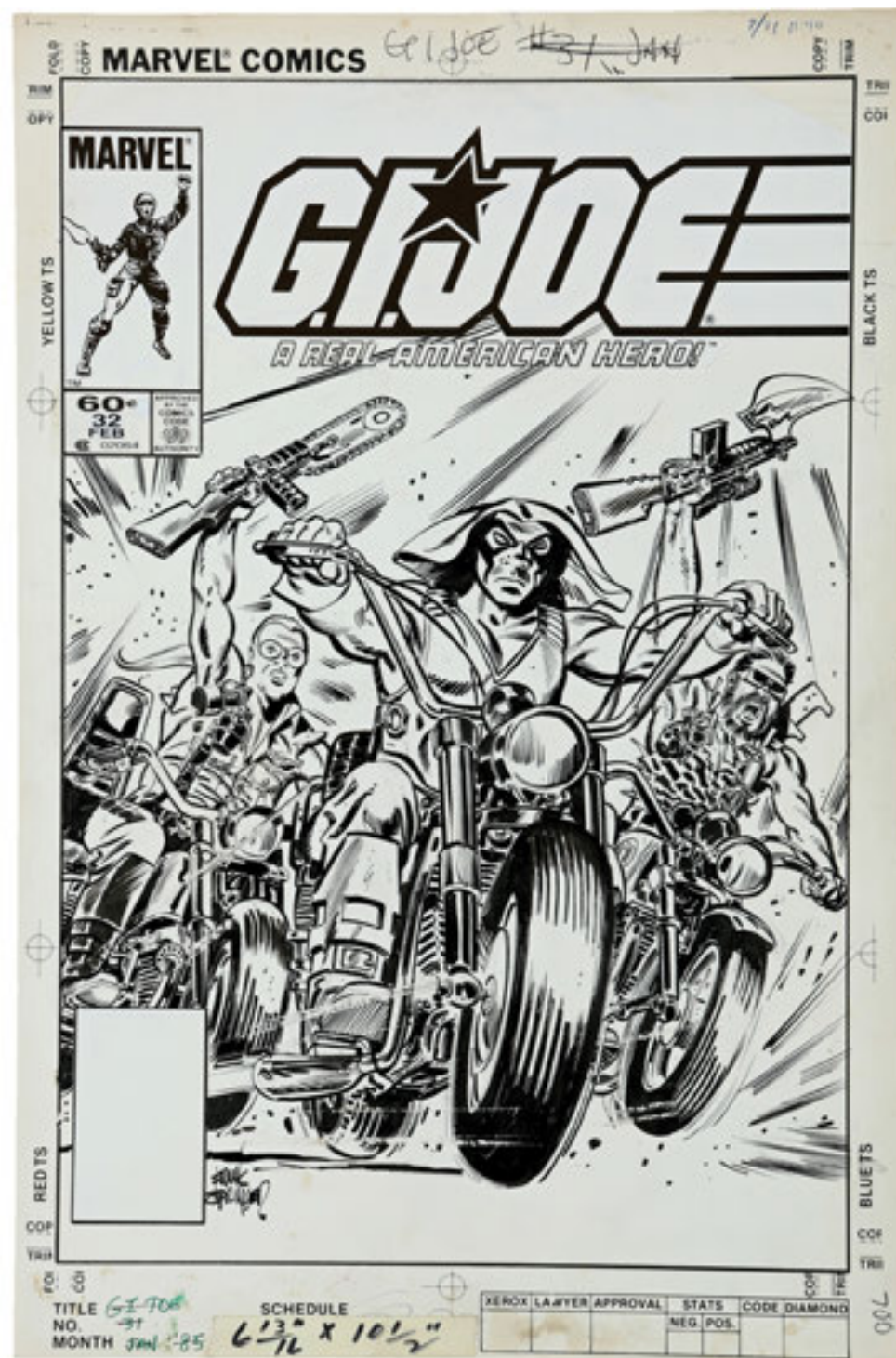

185. Marshmallow-Covered Crushed Police Car Model Miniature Ω

GHOSTBUSTERS (1984)

A marshmallow-covered crushed police car model miniature from Ivan Reitman's supernatural comedy *Ghostbusters*. When Gozer (Slavitz Jovan) faced off against the Ghostbusters, she took the form of the Stay Puft Marshmallow Man and terrorised the streets of New York City. Multiple scenes of the Marshmallow Man crushing cars were filmed, although these were ultimately unused in the final cut.

This car is produced from a standard toy vehicle. As the Stay Puft costume was built at an odd scale, 1/18 scale models were needed. Unable to find a model car that matched this scale, the production located toy cars that were an appropriate size. Notably, these toy cars resembled NYPD cars of the period, but were not marked as such.

Made from a combination of metal and plastic, this car is crushed, melted and aged to appear as though it had an encounter with a ghastly marshmallow giant. Portions of the car are covered with white foam, representing residue from the Stay Puft Man. The piece is finished with a small figure's legs emerging from the inside of the vehicle. This car shows intentional signs of wear and is in very fine overall condition.

Dimensions: 29 cm x 16.5 cm x 2.5 cm (11 1/2" x 6 1/2" x 1")

£1,500-2,000

186. Slimer Maquette Ω

GHOSTBUSTERS II (1989)

A Slimer maquette made for Ivan Reitman's supernatural comedy sequel *Ghostbusters II*. Caught by the Ghostbusters during the first movie, Slimer returned in the sequel as an unpredictable companion to the paranormal investigators.

This production-made maquette is produced in cast resin and painted with detail to match Slimer's ghastly green appearance, including a set of large white teeth and yellow eyes. Originally exhibiting damage to the arms and fingers, the piece has been restored, with its limbs reattached. However, the piece is missing two fingers. Overall, this maquette is in fair condition. Dimensions: 20 cm x 11.5 cm x 18 cm (8" x 4 1/2" x 7")

£3,000-5,000



187. 2nd Unit Clapperboard M

GLADIATOR (2000)

A 2nd Unit clapperboard from Ridley Scott's Oscar®-winning historical epic *Gladiator*. The clapperboard consists of an acrylic slate with wooden clapper sticks fixed on the top.

Used by the 2nd Unit film crew, the piece displays the production title "Gladiator", the name of the Unit Director and Director of Photography Alexander Witt, all engraved in black. Several fields on the piece have been filled in with black ink, including the date "6.7.99", slate "102181 – 1061A" and take "3XY". The clapper displays wear from production use, including minor scuffs to the paintwork on the clapper arm and light surface scratches on the acrylic. Dimensions: 3 cm x 28 cm x 23.5 cm (1 1/4" x 11" x 9 1/4")

£1,500-2,000



188. Battle of Carthage Helmet †Δ

GLADIATOR (2000)

An arena helmet from Ridley Scott's Oscar®-winning historical epic *Gladiator*. The gladiators wore their distinctive helmets during the re-enactment of the famous Battle of Carthage, in which Maximus (Russell Crowe) rallied the desperate gladiators against the charioteers, overcoming all odds to achieve a glorious victory.

Made from fibreglass, the helmet is impregnated with aluminium filings to replicate a metal finish, with a resin spike on top, a metal chain-mail neck protector and a leather tab across the nose. Lined with black fabric and foam for comfort, the helmet displays two leather straps that fasten under the chin. The lining displays damage and marks from production use and age, and minor scratches are present on the fibreglass and leather work. Dimensions: 25 cm x 19 cm x 63 cm (9 3/4" x 7 1/2" x 24 3/4")

£800-1,200



189. Praetorian Guard Costume with Shield and Weapons Ω

GLADIATOR (2000)

A Praetorian Guard costume, with shield and weapons, from Ridley Scott's Oscar®-winning action epic *Gladiator*. The Praetorians protected Roman emperors Marcus Aurelius (Richard Harris) and Commodus (Joaquin Phoenix) and defended Rome on the battlefield of Germania.

This costume is composed of trousers and tunic made of purple wool, over which are worn a set of plastic lorica segmentata (segmented cuirass) body armour and a leather skirt with plastic armour plating. The costume also includes a pair of leather boots, plastic greaves and bracers, a fibreglass helmet with plastic cheek plates and an eagle crest, and a purple wool cape which attaches to the armour with decorative lion resin emblems. The armour is finished in black, with leather strapping to secure it to the wearer. One bracer is marked with "R SR56" and the other with "BR 200".

The costume is paired with a shield, sword and spear. The sword includes a wooden sheath that is covered with canvas. The sword features an aluminium blade with a wooden pommel, hilt and grip.

The spear, or pilum, is made of wood with copper detailing and a wooden spearhead. The spear is finished with a white tassel which attaches to the grip.

The shield is made of formed card with a canvas covering, wooden grips and a plastic boss at the centre. This lot shows wear from use, including minor scratches and marks throughout. However, it remains in fine condition.

Dimensions (sword): 59 cm x 25.5 cm x 131 cm (23 1/4" x 10" x 51 1/2"); (shield): 10 cm x 6 cm x 82.5 cm (4" x 2 1/2" x 32 1/2"); (spear): 7.5 cm x 7.5 cm x 223.5 cm (3" x 3" x 88")

£4,000-6,000

190. Film Car Placard Ω

THE GODFATHER (1972)

A film car placard made for Francis Ford Coppola's Mafia movie *The Godfather*. Car placards were placed inside vehicles in order to display the fact that they were being used as part of the production.

This placard is made of cardboard and features the film's logo, a Paramount logo and other details. The sign shows some aging but remains in fine overall condition. Dimensions: 30.5 cm x 15 cm (12"x 6")

£500-700



191. Michael Corleone's (Al Pacino) Miami Suit †

THE GODFATHER PART II (1974)

Michael Corleone's (Al Pacino) suit worn in Francis Ford Coppola's Oscar® winning gangster film *The Godfather Part II*. Corleone wore his cream suit in the pivotal scenes in which he visits mafia investor Hyman Roth (Lee Strasberg) in Miami and in Cuba to confront him over the assassination attempt on his family. This suit matches to press photographs taken during the filming of these pivotal scenes, which underlined the levels of double-dealing and treachery within the Corleone crime syndicate.

The two-piece single breasted suit is a cream colour with a subtle white-and-green check pattern. Western Costume labels within both the jacket and trousers on which the actors name and measurements are typed. The costume is in excellent production-used condition and is presented on a custom made mannequin.

Dimensions (displayed): 36 cm x 62 cm x 167 cm
(14" x 24.5" x 65.5")

£15,000-20,000



192. Dancing 7Up Can Practice Puppet Ω

THE GOLDEN CHILD (1986)

A dancing 7Up can man practice puppet from Michael Ritchie's supernatural action comedy *The Golden Child*. Imprisoned by the evil Sardo Numspa (Charles Dance), the Golden Child (J.L. Reate) used his powers to transform a Pepsi can into a dancing figurine. This version of the puppet was used as a practice piece by the film's visual effects crew.

Brought to life by Tom St. Amand of Industrial Light & Magic, the puppet consists of an actual 7 Up can that is cut and bent to resemble a human figure. The can is glued over a bendable springs and has a single metal arm. This piece shows some wear and is in fair overall condition. Dimensions: 6.5 cm x 3 cm x 18 cm (2 1/2" x 1" x 7")

£600-800



193. Dancing Pepsi Can Man Stop-Motion Puppet Ω

THE GOLDEN CHILD (1986)

A dancing Pepsi can man stop-motion puppet from Michael Ritchie's supernatural action comedy *The Golden Child*. Imprisoned by the evil Sardo Numspa (Charles Dance), the Golden Child (J.L. Reate) used his powers to transform a Pepsi can into a dancing figurine.

Brought to life by Industrial Light & Magic, the puppet consists of an actual Pepsi can that was reworked into a stop-motion puppet resembling a human figure. The can is adhered to a bendable wire frame and includes nuts embedded in the feet.

Dimensions: 15 cm x 3 cm x 18 cm (6" x 1 1/4" x 7 1/4").

£2,000-3,000



194. Collection of Vintage Fabric Swatches †Δ

GONE WITH THE WIND (1939)

A collection of vintage fabric swatches from Victor Fleming's dramatic masterpiece *Gone with the Wind* and numerous other classic titles released between 1932 and 1940.

The collection is housed in a large wooden box containing rows of cards, each bearing multiple cloth samples and notes in various hands. Most cards are headed with a studio name, followed by a film title. Featured titles in the collection include *Gone with the Wind* (32 cards), *The Hunchback of Notre Dame* (27 cards), *The Man in the Iron Mask* (11 cards), *Stagecoach* (one card) and *Wuthering Heights* (one card).

There are 241 cards in the box, making this an incredible memento from a bygone age of cinema. Each card measures approximately 50 cm x 10 cm (20" x 4") and remains in generally very good condition.

Dimensions (case): 56 cm x 55 cm x 30 cm (22" x 21 1/2" x 12")

£800-1,200

195. Collection of Production Storyboards Ω

THE GOONIES (1985)

A collection of production storyboards from Richard Donner's adventure film *The Goonies*. Printed on three hole-punched sheets of green US letter paper, this set of 17 storyboards depicts several key sequences, including Mikey (Sean Astin) using the doubloon, the wishing well, the Goonies solving the organ trap, the reveal of One-Eyed Willy's pirate ship, and the escape to the beach.

Each page features artwork at the top with a Warner Bros. date stamp, and includes a description of the action printed below. At the lower half of each page are boxes for notes, breakdown of the technical elements, shot number and sequence, frame count and page number. The storyboards remain in very good condition.

Dimensions: 21.5 cm x 28 cm (8 1/2" x 11")

Please note this lot is sold without copyright, reproduction rights, licensing agreements or any other type of legal release.

£600-800



196. Mikey's (Sean Astin) Hero Doubloon Ω

THE GOONIES (1985)

Mikey's (Sean Astin) hero doubloon from Richard Donner's adventure film *The Goonies*. Mikey used a doubloon he found in his attic to match the lighthouse, a rock and a restaurant to the Goonies' treasure map. This moment was achieved via an insert shot, by which the doubloon was shot on a bluescreen and matched up with photography to make it align with the lighthouse, rock and restaurant. This item is screen-matched to the doubloon held by Mikey in this visual-effects shot.

around the perimeter, with crowns and fleur-de-lis in the centre. The opposite side resembles an Elizabeth I sixpence and is stamped with "POSVI", "IVTOR" and a shield crest, with much of the surface intentionally weathered away to appear aged. The coin is painted copper in colour, with green and white rust. The doubloon shows minor wear from production use and remains in very fine condition.

Dimensions: 7 cm x 6 cm x 1/2 cm (2 3/4" x 2 1/2" x 1/8")

Made of metal, the doubloon resembles a large coin with three holes. One side resembles a French coin and is stamped with "VINC", "1632", "CHRS", and "REGN"

£10,000-15,000

197. One-Eyed Willy's Ship Blueprint ΩΔ**THE GOONIES (1985)**

A blueprint of One-Eyed Willy's ship from the production of Richard Donner's adventure film *The Goonies*. One-Eyed Willy's pirate ship was seen at the end of the film when the Goonies discovered the fabled lost treasure and came to a final confrontation with the villainous Fratelli family.

This blueprint was originally drafted by assistant art director Joseph C. Nemecek III, and shows the pirate ship from the side and top. The drafting elevation features extensive annotation and measurements throughout. The blueprint shows minor wear due to production use and age, with creases to the paper from folding.

Dimensions (unfolded): 65 cm x 60 cm (25 ¾" x 23 ¾");
(folded): 33 cm x 26 cm (13" x 10 ¼")

Please note this lot is sold without copyright, reproduction rights, licensing agreements or any other type of legal release.

£1,500-2,500

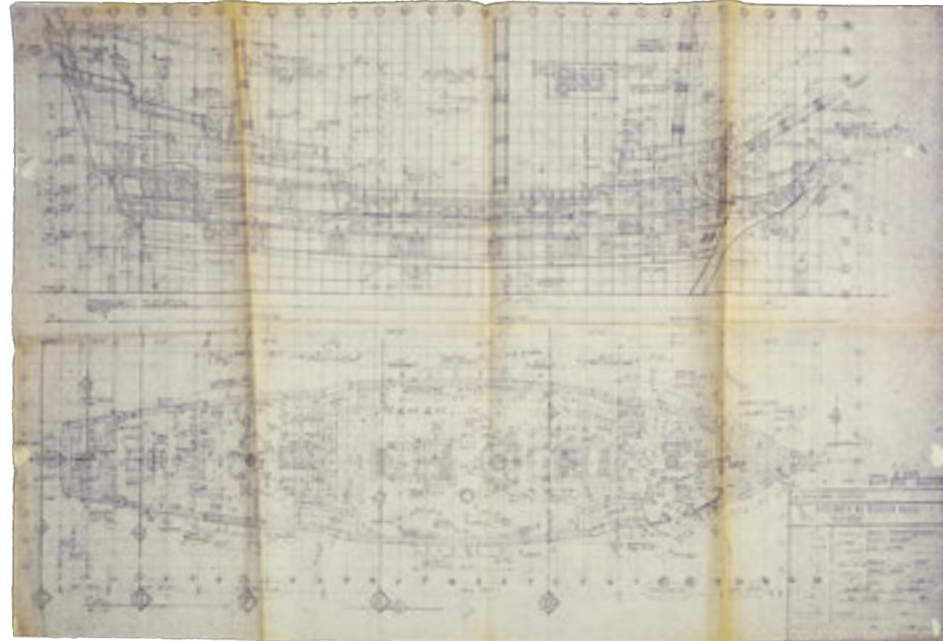
**198. Dave Carson Hand-Drawn One-Eyed Willy's Ship Pastel Concept Artwork** ΩΔ**THE GOONIES (1985)**

Dave Carson hand-drawn pastel concept artwork depicting One-Eyed Willy's pirate ship from the production of Richard Donner's adventure film *The Goonies*.

Drawn by visual effects art director Dave Carson, the wide-format concept art features the legendary pirate ship floating in a watery cave. The drawing is done using colourful pastels on black paper. The artwork is in very fine condition.

Dimensions: 36 cm x 16 cm (14" x 6 ¼")

Please note this lot is sold without copyright, reproduction rights, licensing agreements or any other type of legal release.

£1,500-2,500

199. Gremlin Marionette Puppet Ω**GREMLINS 2: THE NEW BATCH (1990)**

A Gremlin marionette puppet from Joe Dante's horror comedy *Gremlins 2: The New Batch*. A horde of Gremlins ransacked a mall and stole various items that they then wore. This marionette was designed for shots featuring full Gremlin bodies in scenes depicting chaos at the mall and in the television studio. Made by Rick Baker's team at Cinovation Studios, the puppet would have been operated using the attached traditional marionette bars.

This polyfoam puppet is strung to wooden controller bars and is detailed with a green-and-brown spotted color scheme. The face features detailed latex teeth, a painted foam-latex tongue and acrylic eyes. Finally, the Gremlin has some loot from raiding the mall, including a necklace and a bow tie around the leg. The puppet exhibits some wear to the latex, including some cracking around the moveable joints at the shoulders and legs, and a portion of foam latex is missing from the belly. However, the foam still retains its soft texture throughout the puppet. This piece is in fine overall condition.

Dimensions (puppet body): 40.5 cm x 25.5 cm x 86.5 cm (16" x 10" x 34");
(with controls): 40.5 cm x 25.5 cm x 127 cm (16" x 10" x 50")

£4,000-6,000



200. Hamlet's (Mel Gibson) Chalice M

HAMLET (1990)

Hamlet's (Mel Gibson) chalice from Franco Zeffirelli's Shakespearian tragedy *Hamlet* (1990). Hamlet's chalice was kept on his desk during the early scenes with King Claudius (Alan Bates). He carried it during the banquet in which The Murder of Gonzago was staged, and handed it to Polonius (Ian Holm).

Made of cast resin, the medieval-style chalice consists of a large hemispherical cup with an ornate stem and rounded base. It has been realistically painted to resemble copper. Intricate Celtic-style detail surrounds the lip, with eight coloured beads embedded within, styled like precious stones. The piece has been purposely distressed to create an aged, handmade look. The base has some chipped paintwork and the piece displays minor wear from production use. Dimensions: 18 cm x 13.5 cm x 13.5 cm (7" x 5 1/4" x 5 1/4")

£800-1,200



201. The Killer's Mask Ω

HAPPY DEATH DAY (2017)

The killer's mask from Christopher Landon's time-bending horror film *Happy Death Day*. College student Tree Gelbman (Jessica Rothe) continually relived the day of her murder at the hands of a masked killer. Designed by Tony Gardner, the mask resembles a wide-eyed baby, grinning with a single tooth.

The mask is made of vacuum-formed plastic with black mesh behind the eyes, interior padding and an elastic headband for securing to the head. The piece is hand-painted and distressed to appear dirty and scratched. The mask remains in very fine condition. Dimensions: 25 cm x 14 cm x 27 cm (10" x 5 1/2" x 10 1/2")

£2,000-3,000

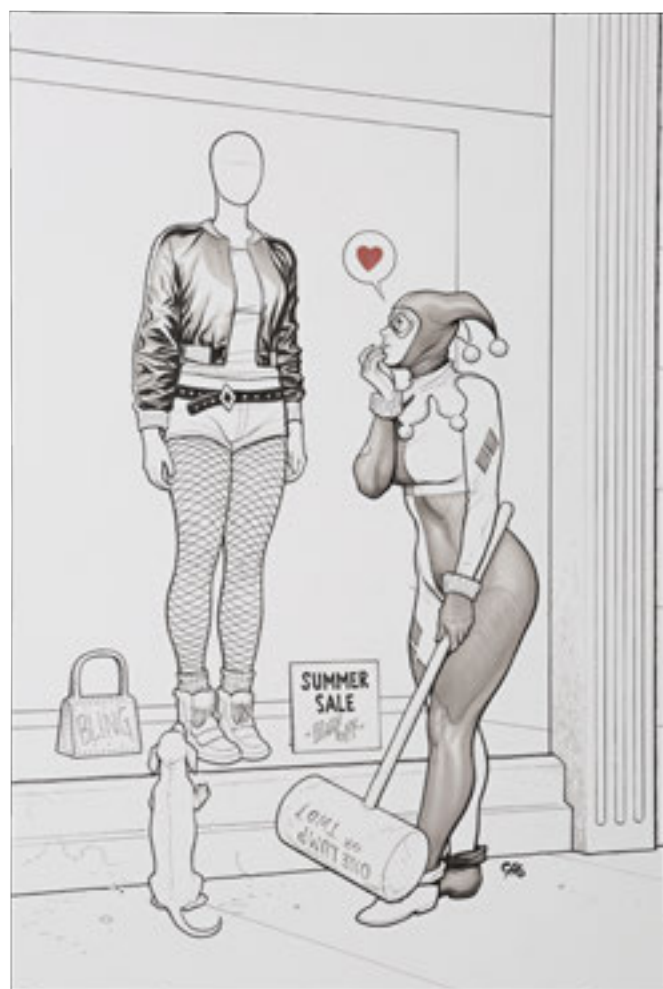

202. Frank Cho Hand-Drawn Variant Cover Artwork Ω

HARLEY QUINN #18 (2017)

Hand-drawn variant cover artwork by Frank Cho for *Harley Quinn #18*. Alluding to a scene in the film *Suicide Squad*, the cover artwork shows Harley Quinn in her traditional costume, as she admired a shop display of an outfit that resembled her film costume.

This original pencilled, inked and toned artwork is drawn on oversized Bristol board by Frank Cho. The piece features Cho's signature drawn near Harley's feet. Included with the lot is a reference copy of *Harley Quinn #18*, the comic book in which this art was originally published. Some white-out correction fluid is present, but the artwork is in very good condition.

Dimensions: 54 cm x 35.5 cm x 1 cm (21" x 14")

Please note this lot is sold without copyright, reproduction rights, licencing agreements or any other type of legal release.

£3,000-4,000



203. J.K. Rowling and Cast Autographed Books M

HARRY POTTER AND THE PHILOSOPHER'S STONE (2001)

A copy of *Harry Potter and the Philosopher's Stone*, autographed by author J.K. Rowling, and a copy of *Harry Potter and the Prisoner of Azkaban*, autographed by the three lead actors from the *Harry Potter* film series.

The paperback first book, from the 45th print run, is autographed by the writer in blue ballpoint pen on the title page. The paperback third book, from the 18th print run, is autographed by Daniel Radcliffe, Emma Watson and Rupert Grint in black ink on the title page.

Both books remain in very good condition, with slight yellowing to the pages and small chips to the covers.

Dimensions (largest): 3 cm x 13 cm x 20 cm (1" x 5" x 7 3/4")

£600-800

204. Ollivanders Wand Boxes M

HARRY POTTER AND THE PHILOSOPHER'S STONE (2001)

A set of two Ollivanders wand boxes used in Chris Columbus' fantasy-adventure film *Harry Potter and the Philosopher's Stone*. Stacks of boxes filled the shelves of Ollivanders, the shop Harry (Daniel Radcliffe) visited in Diagon Alley to purchase a wand.

These boxes were gifted to attendees of the film's world premiere at Leicester Square in 2001. The cardboard boxes differ in shape and lid style — one being burgundy with a black marbled effect, the other brown and textured. The sealed lids are decorated with a golden "Ollivanders"-branded label and a sticker on the left edge that features a wand-maker measurement. The measurement stickers have begun to peel at the edges and both box lids display minor wear. Dimensions (first box): 36.5 cm x 6 cm x 5 cm (14 1/2" x 2 1/4" x 2"); (second box): 36.5 cm x 8.5 cm x 3 cm (14 1/2" x 3 1/2" x 1 1/4")

£400-600



205. Cast Autographed Poster M

HARRY POTTER AND THE PHILOSOPHER'S STONE (2001)

An autographed promotional poster from Chris Columbus' fantasy-adventure film *Harry Potter and the Philosopher's Stone*.

Designed by legendary poster artist Drew Struzan, the illustrated image depicts Harry (Daniel Radcliffe), Ron (Rupert Grint), Hermione (Emma Watson), Hagrid (Robbie Coltrane), Dumbledore (Richard Harris), the Gringotts Goblin (Warwick Davis), Hedwig, Hogwarts School and Quidditch players astride brooms, above the alternative US release title "Harry Potter and the Sorcerer's Stone". The poster has been autographed in gold pen by Daniel Radcliffe, Rupert Grint and Emma Watson, each writing their name alongside their likeness. It remains in very good condition.

Dimensions: 69 cm x 101 cm (27" x 40")

£300-500

206. Gerhard Hand-Drawn 2016 Dark Hall Mansion Poster Artwork and Signed Print Ω

HARRY POTTER AND THE PHILOSOPHER'S STONE (2001)

Hand-drawn *Harry Potter and the Philosopher's Stone* poster artwork by Gerhard, created exclusively as a limited-release for Dark Hall Mansion as part of its Seminal Film Series in 2016. The artwork is rendered in pencil and ink on sturdy illustration board, with Gerhard's detailed crosshatching technique applied throughout to provide different tones and shading. It shows Harry seated at a window in Gryffindor Tower, gazing out on a moonlit night, with the lower two-thirds of the poster depicting the first-year students travelling across the lake to Hogwarts on their first journey to the magical school. The artwork is signed by Gerhard at the bottom right of the illustration board.

Included with the lot is a limited-edition, autographed blue-edition print, which is signed "AP 8/15 Gerhard" at the bottom of the poster. Both items show minor wear due to use and storage, with dents in their corners. However, the artwork and poster both remain in very fine overall condition.

Dimensions (artwork): 91.5 cm x 61 cm x 0.5 cm (36" x 24"); (poster): 91.5 cm x 61 cm x 0.5 cm (36" x 24")

£3,000-4,000



207. Cast Autographed Book †Δ

HARRY POTTER AND THE GOBLET OF FIRE (2005)

A copy of *Harry Potter and the Goblet of Fire* autographed by the three principal actors from the film adaptation. The hardback book, from the 23rd print run, is autographed by Daniel Radcliffe, Emma Watson and Rupert Grint in black and blue ballpoint pen on the title page, and features cover artwork of Harry on his broomstick tackling a dragon, with an image of Hogwarts School on the reverse.

The book remains in very good condition, with very minor wear to the edges of the dust jacket.

Dimensions: 6 cm x 14 cm x 21 cm (2 1/2" x 5 1/2" x 8")

£600-800

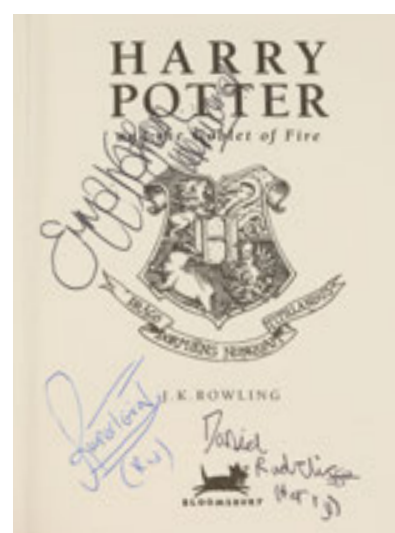
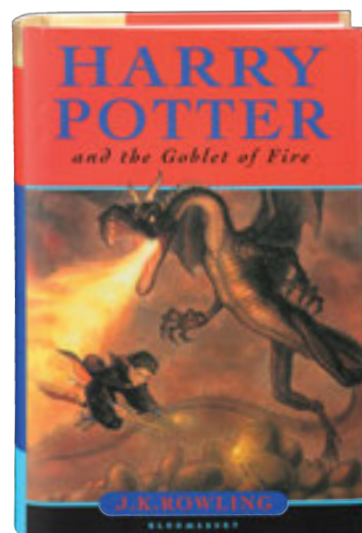

209. Wink's (Brian Steele) Animatronic Creature Head M

HELLBOY II: THE GOLDEN ARMY (2008)

Wink's (Brian Steele) animatronic head from Guillermo del Toro's fantasy adventure *Hellboy II: The Golden Army*. The fully articulated head was created for the character Wink — friend and henchman to Prince Nuada (Luke Goss).

Constructed from foam latex over a padded fibreglass skullcap, the cave troll face features hand-punched hair and plastic spines, a fantastical acrylic eye, and resin tusks, teeth and gums, all painted to a high level of detail. A line of metal poppers is sewn along the neckline for securing to a suit. Inside, the skullcap is labelled "H3" in blue ink.

The remote-controlled head was designed with articulating facial features, allowing movement to the jaw, lips, nose and eye. It is presented on a custom-made stand, and several servo controls extend from the back. The mask shows evidence of wear, including cracks to the foam latex and some missing spines. Dimensions (displayed): 30 cm x 32 cm x 63 cm (12" x 12 1/2" x 25")

This item contains electrical components. While every effort is made to describe them accurately, no guarantee or warranty is made as to the functionality, lifespan or safety of those components. It is entirely incumbent on the new owner to satisfy themselves as to their safe use and maintenance.

£4,000-6,000

208. Sammael Animatronic Creature Head M

HELLBOY (2004)

An animatronic creature head from Guillermo del Toro's fantasy action-adventure *Hellboy*. Created for Sammael's subway showdown with Hellboy (Ron Perlman), the head has a fibreglass core, with latex and urethane skin and fangs, silicone eyes and rune-etched facial horns. It is painted in mixed blues, greens, greys and reds.

Designed by make-up artist Steve Wang, the head would have been used for close-up shots, so the rear section is open for affixing to a mannequin. Animatronic jaw and eyeball mechanisms are visible inside, with cables and a nylon securing strap running from the back.

A black polystyrene bust and fibreglass helmet, on which "Min Function #1" is handwritten, support the head. The display rests on a heavy acrylic base. The head shows some paint chipping and worn silicone edges from production use, while its eyes have deteriorated and become gelatinous. Dimensions: 54 cm x 39.5 cm x 52.5 cm (21 1/4" x 15 1/2" x 20 3/4")

This item contains electronic components. While every effort is made to describe them accurately, no guarantee or warranty is made as to functionality, lifespan or safety of those components. It is entirely incumbent on the new owner to satisfy themselves as to their safe use and maintenance.

£4,000-6,000



210. Hellboy's (Ron Perlman) Duster Ω

HELLBOY II: THE GOLDEN ARMY (2008)

Hellboy's (Ron Perlman) duster from Guillermo del Toro's fantasy action-adventure sequel *Hellboy II: The Golden Army*. Hellboy wore his duster throughout the film as he worked to stop the evil elven prince Nuada (Luke Goss).

The duster is made from thick cotton material and features a collar and leather buckles down the right arm. Notably, one sleeve is longer than the other, in order to accommodate Hellboy's Right Hand of Doom. An elastic band is present on the longer sleeve to provide a tight fit around the wearer. The long sleeve also displays a leather B.P.R.D. (Bureau for Paranormal Research and Defense) emblem patch, as well as a small embroidered shamrock patch. The duster shows intentional wear from production, such as fraying and dirtying, and is in very fine overall condition.

£5,000-7,000



211. LeMarchand's (Bruce Ramsay) Lament Configuration Box Ω

HELLRAISER IV: BLOODLINE (1996)

LeMarchand's (Bruce Ramsay) Lament Configuration box from Kevin Yagher's science-fiction horror film *Hellraiser IV: Bloodline*. Featured throughout the film, the Lament Configuration box acted as a door to a dimension of suffering, and also summoned the demonic Cenobites.

This box is made of wood and is expertly painted black with ornate gold foil laid over the surface. The static puzzle box is cast in a star position and shows four screw holes at the bottom. A letter of authenticity accompanies the piece and is signed by Gary J. Tunnicliffe, make-up effects designer for the film. Portions of the metal detailing are loose, and the piece is in fair overall condition. Dimensions: 10 cm x 10 cm x 8 cm (4" x 4" x 3")

£3,000-5,000



212. Hercules' (Dwayne Johnson) Nemean Lion Stunt Headdress Ω

HERCULES (2014)

Hercules' (Dwayne Johnson) Nemean lion stunt headdress from Brett Ratner's mythological action film *Hercules*. The mighty son of Zeus wore his headdress when he was introduced during the opening battle, and also later as a hood on his back.

The lion headdress is made of foam urethane and faux fur over an adjustable plastic headband. The Nemean lion face features acrylic eyes and its face is frozen in a snarl, with the nose wrinkled and the top row of resin teeth bared. The foam lion head is fastened over a hard hat ratchet suspension band that adjusts to the user's head.

The headdress shows minor wear to the faux fur and the whiskers, which are bent out of shape.

Dimensions: 33 cm x 27 cm x 20 cm (13" x 10 1/2" x 8")

£3,000-4,000



213. David James Limited Edition Print Boxed Set †Δ

HIGHLANDER (1986)

A set of 15 limited edition prints from Russell Mulcahy's 1986 fantasy adventure *Highlander*. Taken by David James, the photographs comprise number 168 of 500 sets.

Each hand-numbered A4 photograph is printed on beige card adhered to an A3 textured card sheet. These beautiful black-and-white portraits and action scenes feature Connor MacLeod (Christopher Lambert), the Kurgan (Clancy Brown), Ramirez (Sean Connery) and Heather (Beatie Edney). They are presented in their original black card box featuring the text "Highlander – There can be only one" in faux-gold print.

Displaying only light marks and creases, the set is accompanied by an official certificate signed by David James, dated "Oct 1985". The box shows considerable signs of wear.

Dimensions (in box): 42 cm x 33 cm x 2 cm (17 1/4" x 13 1/4" x 3/4")

£200-300



214. Fasil's (Peter Diamond) Hero Toledo Salamanca Rapier †

HIGHLANDER (1986)

Fasil's (Peter Diamond) hero Toledo Salamanca rapier from Russell Mulcahy's fantasy adventure *Highlander* (1986). Iman Fasil hunted down fellow Immortal Connor MacLeod (Christopher Lambert) to a wrestling match at Madison Square Garden, challenging him to a sword fight in the car park, ultimately losing his head to MacLeod. Forensic pathologist Brenda Wyatt (Roxanne Hart) later found it hidden beneath a car and recognised its rarity. The hilt screen-matches to the moment when Fasil's sword lands on the bonnet of a car. The sword fights were choreographed by renowned sword master Bob Anderson.

Custom-made for the production, the hero sword has a narrow, polished stainless-steel blade. The elaborately detailed cast-metal guard and pommel feature 'carved' details, and are painted to resemble gold and inset with a number of pink and clear faux gems. The grip is made of resin and finished to imitate ivory. A green velvet ricasso detail sits below the guard. The piece displays some scrapes, pitting and corrosion from production use, with the blade clean and displaying minimal wear. Some of the gems are missing from the guard.

Dimensions: 110 cm x 17 cm x 9 cm (43" x 6 ¾" x 3 ½")

£15,000-20,000





215. The Kurgan's (Clancy Brown) Costume M

HIGHLANDER (1986)

The Kurgan's (Clancy Brown) costume from Russell Mulcahy's action-adventure *Highlander*. The Kurgan wore his armour during his first battles with Connor MacLeod (Christopher Lambert) and Ramirez (Sean Connery).

The costume consists of a cowl, body armour, shoulder guards and a single leg greave, with a leather belt and black faux-fur sporran. A replica helmet cast from the original production moulds completes the ensemble.

Each piece has been styled to resemble animal bones. Formed as a bony muscled torso, the body armour fastens with six brown leather straps and features a high cowl inlaid with black faux fur. Leather straps and strands of chain mail hang from each shoulder guard. Made to match the armour, the leg greave fastens with three leather straps. The leather belt is inlaid with plastic plates styled to look like metal, while the sporran features long, black faux-fur tails.

The helmet is a replica made from the original production mould. It features a brown-and-black faux-fur plume styled to match the sporran, and a buckled leather chinstrap. Each item has been distressed for production. The helmet's long teeth are missing their sharp points, and the faux fur shows ageing and production-related wear. The costume is mounted on a custom mannequin display with a light-up base featuring the *Highlander* logo and artificial rock detail.

Dimensions: 45 cm x 61 cm x 211 cm (17 ¾" x 24" x 83")

£10,000-15,000



Moviestore Collection/REX/Shutterstock

216. The Kurgan's (Clancy Brown) Sword M

HIGHLANDER (1986)

The Kurgan's (Clancy Brown) sword from Russell Mulcahy's fantasy adventure *Highlander*.

This authentic weapon would have been used for scenes where durability was needed, like breaking the table in the mill and for SFX. It was specifically used for the initial, pyrotechnic-enhanced swing of the first Kurgan/Connor MacLeod (Christopher Lambert) New York battle; a bird's eye view of the Kurgan advancing on Ramirez (Sean Connery); on the staircase during the Quickening following Ramirez' beheading; and during the final Kurgan/McLeod duel. In the Blu-ray extras, unused footage of the Kurgan's beheading also features this sword.

The piece can be identified in the film from its shorter one-and-a-half hand grip and the way Clancy Brown had to wield it due to its weight.

Inspired by the German bidenhänder and Scottish claymore, this hero broadsword was created at Pinewood Studios by Effects Associates. It is the only Kurgan sword from the film featuring a one-piece steel blade. The other steel sword made for the production is the cased sword the Kurgan assembled in his hotel room. Lighter, two-handed duralium-bladed stunt swords were used for fight scenes, the scene in which the Kurgan practiced in his hotel room, and other close-ups.

The one-piece sword differs from the cased and duralium swords with its aluminium cross guard. The distinctive spikes were added during restoration, reproduced from photographs and details given by the Property Master, and differing from the longer, fixed spikes on the duralium swords.

The handle is wrapped in black faux-reptile skin and criss-crossing black leather thongs, added during restoration to cover the brown leather base wrapping and mirror the sword's screen appearance.

The four-foot blade features a deep central fuller, blunted along the edges and ending in a sharp point - the spikes' edges have been similarly blunted. Surface rust has been cleaned away and a dent removed from the tip, although production-related scratches and dents along the edges remain. The blade, guard and pommel have been polished to a smooth shine. Documents explaining the sword's history and restoration are included along with a letter from the prop master, John Allenby, confirming the facts and authenticity.

Dimensions: 126 cm x 26 cm x 9 cm (49 ½" x 10 ¼" x 3 ½")

£10,000-15,000





217. Connor MacLeod's (Christopher Lambert) Hero Katana M

HIGHLANDER II: THE QUICKENING (1991)

Connor MacLeod's (Christopher Lambert) hero katana from Russell Mulcahy's fantasy sequel *Highlander II: The Quickening*. Initially wielded by Ramirez (Sean Connery), MacLeod took the sword from his mentor after escaping a giant extractor fan with Louise (Virginia Madsen), using it in his duel with General Katana (Michael Ironside) during their final battle.

Authentically designed, the katana would have been used for close-ups and scenes in which a more detailed version of the sword was required. Its solid resin handle has been styled to resemble ivory inlaid with feudal scenes, animals and decorative detail. An ornate Japanese dragon head forms the pommel, with its tail wrapped around the hilt. A hole for hanging has been drilled through the hilt's top end.

The curved steel blade features a rippled hamon line, common in medieval Japanese swords. Traditionally caused by 'quenching', this was created for production by acid etching. A gold-coloured metal tsuba guard completes the weapon, which is sheathed in a toughened black leather scabbard with nylon carrying straps.

Displaying very minor marks from production, the blade remains highly polished and retains its sharp point and edge. The hilt has been purposely distressed for a yellow, centuries-old appearance. Minor dents are visible along the length of the scabbard.

Dimensions: 104 cm x 8 cm x 8 cm (41" x 3 1/4" x 3 1/4")

£6,000-8,000



218. Duncan MacLeod's (Adrian Paul) Hero Sword and Scabbard †Δ

HIGHLANDER (TV SERIES 1992-1998)

Duncan MacLeod's (Adrian Paul) hero sword and scabbard from the TV series *Highlander*. Duncan MacLeod used his sword throughout his tireless crusade against the evil Immortals.

This sword is a hero version, used in close-up shots for which the detail of his katana needed to be on display.

The blade is made of steel with a tempered hamon line along the blade edge. The sword is dressed in traditional Japanese fashion, with a machined tsuba handguard and habaki, which provides a seal while the sword is sheathed. A brass-coloured collar secures the resin dragon's-head grip, which is finished to replicate the appearance of ivory. The black scabbard is made of aluminium with a plastic grommet at the opening and black thread wrapped around the top to secure it to a belt.

The collars of the swords used in Season 3 were painted so as to match a different sword used in Seasons 1 and 2, with the detailing on this particular sword indicating its use in Seasons 4, 5 and 6.

The elegant weapon is accompanied by two documents from the on-set armourer confirming and detailing its history, and an additional letter from the producer of the series confirming its provenance. The sword is in excellent production-used condition, with the scabbard displaying light scratches and chips.

Dimensions (sheathed): 107 cm x 8 cm x 8 cm (42" x 3" x 3")

£3,000-£5,000

219. John Howe Hand-Painted "The Hobbit" Artwork Ω

THE HOBBIT: THE DESOLATION OF SMAUG (2013)

A John Howe hand-painted *The Hobbit* artwork, issued as the grand prize in a Warner Bros. contest. Known for his illustrations for J.R.R. Tolkien's work, Howe has painted book covers for the classic fantasy novel *The Hobbit* and served as a concept artist for both *The Lord of the Rings* and *The Hobbit* movie trilogies.

piece shows some signs of wear, including minor creases near the edges, but is in very fine overall condition.

Dimensions: 65 cm x 53.5 cm x 1 cm (25 1/2" x 21" x 1/4")

Painted in 2016, the piece depicts Bilbo Baggins (Martin Freeman) and some of his dwarf companions escaping Thranduil's (Lee Pace) realm via floating wine barrels. It is accomplished with watercolor and gouache on illustration board, and the artist's signature is present at the bottom left corner, dated 2016. The

Please note this lot is sold without copyright, reproduction rights, licensing agreements or any other type of legal releases.

£4,000-6,000

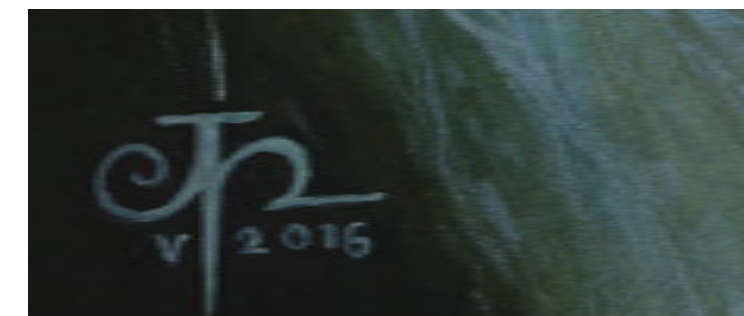

220. "Wet Bandits Escape" Newspaper Ω**HOME ALONE 2: LOST IN NEW YORK (1992)**

A "Wet Bandits Escape" newspaper from Chris Columbus' Christmas comedy *Home Alone 2: Lost in New York*. A torn Chicago Sun-Times newspaper ominously blew onto the McCallister porch the night before Kevin's (Macaulay Culkin) unplanned trip to the Big Apple.

Printed on tabloid paper, the Chicago Sun-Times features the bold headline "'Wet Bandits' escape during prison riot" and shows mugshots of the dishevelled Harry (Joe Pesci) and Marv (Daniel Stern), following their painful encounter with Kevin in the previous film. The front page features two articles, one titled "Police warn of holiday break-ins", and the other "Local manhunt ensues". The text for each article is pasted from an unrelated news story. The back cover of the newspaper is the "Sports Wednesday" section, and covers various sports headlines. The newspaper remains in very good condition.

Dimensions: 37.5 cm x 29 cm (14 ¾" x 11 ½")

£800-1,200

**221. Joe Jusko Hand-Painted Hulk Artwork** Ω**UNIVERSAL ORLANDO - INCREDIBLE HULK COASTER (1998)**

Hand-painted Hulk artwork by Joe Jusko for The Incredible Hulk Coaster at Universal's Islands of Adventure theme park at Universal Orlando Resort. Created in 1998, this artwork was made as a promo piece for the ride's debut. The artwork is an updated reimagining of a famous Hulk Magazine #26 cover pencilled by John Buscema and also painted by Joe Jusko.

The artwork is rendered in acrylics on oversized illustration board and shows the Hulk poised to attack. The artwork is signed "JUSKO 98" and is housed in a metal frame with a mat board. Included with the lot is a reference copy of Hulk Magazine #26, which features the original cover on which this piece was based. The artwork remains in very fine condition.

Dimensions (artwork on page): 37 cm x 35.5 cm (14 ½" x 14"); (mat frame): 58 cm x 71 cm (22 ¾" x 28"); (metal frame): 64 cm x 77.5 cm x 2.5 cm (25 ¼" x 30 ½" x 1")

Please note this lot is sold without copyright, reproduction rights, licensing agreements or any other type of legal release.

£3,500-4,500

**222. President Alma Coin's (Julianne Moore) Inauguration Costume** M**THE HUNGER GAMES: MOCKINGJAY — PART 2 (2015)**

President Alma Coin's (Julianne Moore) costume from Francis Lawrence's dystopian action film *The Hunger Games: Mockingjay – Part 2*. Coin wore her costume during her brief inauguration period as she prepared to execute former Panem president Snow (Donald Sutherland) while attempting to instigate another Hunger Games.

The distinctive grey costume consists of a cotton jacket with an attached felt cape, a polyester blend V-neck T-shirt, elasticated leggings, a pair of leather gloves and matching knee-high zip-up boots. The jacket features a small hole on the left breast from the scene in which Katniss (Jennifer Lawrence) shoots Coin with an arrow. Labels are adhered to the collar of the jacket and waistband of the trousers, each reading "Coin 4". The T-shirt is marked size "S/P" and the gloves are marked size 7. The costume shows light wear from production use.

£1,000-1,500

**223. Alien Puppet and Mothership Console Model Miniatures** Ω**INDEPENDENCE DAY (1996)**

Alien puppet and mothership console model miniatures from Roland Emmerich's sci-fi action blockbuster *Independence Day*. Captain Steven Hiller (Will Smith) and David Levinson (Jeff Goldblum) saw aliens working at computer consoles when they flew into the mothership to upload a virus.

The poseable alien puppet is made of clear urethane over a metal armature and is expertly painted by the production. The computer console and chair are made of resin, with the back rest and the front console sliding into place over the chair.

Fitted into the monitors are small blue bulbs with cut wires that would have illuminated the alien seated at the station. The alien console resides on a dense foam surface taken directly from the mothership model miniature. The alien shows minor wear with small breaks to the urethane where the metal armature protrudes from the skin. The console shows small breaks to the resin, while the mothership surface base shows repaired breaks in the foam at one corner. The set remains in good overall condition. Dimensions (alien): 13 cm x 18 cm x 34 cm (5" x 7" x 13 ½"); (console): 28 cm x 24 cm x 24 cm (11" x 9 ½" x 9 ½"); (mothership surface): 79 cm x 34 cm x 9 cm (31" x 13 ½" x 3 ½"); (display): 83 cm x 38 cm x 35 cm (32 ¾" x 15" x 13 ¾")

£2,000-3,000

224. Crew Cap M**RAIDERS OF THE LOST ARK (1981)**

A crew cap from the production of Steven Spielberg's action-adventure classic *Raiders of the Lost Ark*. Crew members were given these caps during their time working on set. This style of cap was also worn by Spielberg himself in famous behind-the-scenes footage of the film.

The beige baseball cap features a cream mesh back with an adjustable strap. The distinctive movie logo is embroidered in yellow, red and black on a patch on the front. The cap is not sized and the adjustment strap has snapped since production, but it otherwise remains in good, worn condition.

£300-500





225. Indiana Jones' (Harrison Ford) Revolver US

RAIDERS OF THE LOST ARK (1981)

Indiana Jones' (Harrison Ford) revolver from Steven Spielberg's action-adventure classic *Raiders of the Lost Ark*. Indiana Jones used his revolver in numerous scenes throughout the film, as he attempted to unearth the Ark of the Covenant before it fell into the hands of Nazis.

Used for production at Elstree Studios and in Tunisia, this pistol is believed to be one of two revolvers used by Ford. This Hand Ejector 2nd Model shot .455 blanks and was produced by Smith & Wesson. It is stamped with the serial number 37891 and was rented to the production by Bapty, a well-known armorer in the UK.

The production made several modifications to the pistol in order to make it a unique piece. The barrel has been bored out and shortened, while a custom-made ramped front sight has been added. A patina has been applied to the revolver, giving it the well-worn look one would expect from a gun belonging to the famous adventurer. The walnut grips feature a diamond pattern and are stamped with gold Smith & Wesson logos. A swivel lanyard is present underneath the grips.

Raiders of the Lost Ark was nominated for nine Academy Awards®, including Best Picture and Best Director, and won five, including Best Art Direction and Best Visual Effects. Harrison Ford won a Saturn award for his portrayal of Indiana Jones. Indiana Jones was named the number two hero of all time on AFI's "100 Heroes and Villains" list, and *Raiders of the Lost Ark* was named the 10th most thrilling film in the first century of cinema. It was selected by the US Library of Congress for preservation in the National Film Registry. On a list of the 500 Greatest Movies of All Time, Empire magazine ranked *Raiders* number two. It has been cited by numerous film-makers as an inspiration on their careers. The revolver shows intentional wear to its finish and it is in very fine overall condition.

Dimensions: 22 cm x 4.5 cm x 14.5 cm (8 1/2" x 2" x 5 1/2")

This weapon has been permanently and sympathetically deactivated to UK legal requirements (at the time of deactivation) and no longer retains any functional capacity to fire. It is accompanied by a proof house certificate of deactivation. The weapon may require further deactivation and re-certification prior to shipping at the buyers expense, based upon current legislation, buyer and weapon location. It is solely the buyer's responsibility to check, prior to bidding, the legal status of this weapon within their own country and the importation thereof.

£40,000-60,000





227. Indiana Jones' (Harrison Ford) Bullwhip Ω

INDIANA JONES AND THE TEMPLE OF DOOM (1984)

Indiana Jones' (Harrison Ford) bullwhip from Steven Spielberg's action adventure sequel *Indiana Jones and the Temple of Doom*. Synonymous with his character, Indiana Jones carried his bullwhip throughout his adventures in all four Indiana Jones films, and notably throughout his adventure in the Temple of Kali.

Under the supervision of Glenn Randall, stunt co-ordinator for *Raiders of the Lost Ark*, Ford learned how to use the bullwhip between takes. Continuing to hone his skills with a whip during the production of the sequel, Harrison Ford whipped a sword from a Thuggee cultist in a single take. This was major achievement for the actor, who had injured his wrist in an earlier career as a carpenter.

The No. 455 series bullwhip was made by master whip maker David Morgan, who also made whips for Catwoman (Michelle Pfeiffer) and Zorro (Antonio Banderas). While additional bullwhips were made for the sequel, a number of whips are believed to be reused from the original film. The piece is 10 feet long and constructed from 12-plait, natural tan kangaroo hide, with a wrist loop attached to the butt of the diamond-braided handle. Accompanying this lot is a Letter of Authenticity from the Comisar Collection.

Displaying signs of natural wear from the production, with the leather on the wrist loop broken and frayed on one end, the bullwhip remains in very fine condition.

Dimensions (unfurled): 325 cm x 4 cm x 4 cm (128" x 1 1/2" x 1 1/2"); (coiled): 35.5 cm x 26.5 cm x 4 cm (13" x 10 1/2" x 1 1/2")

£50,000-70,000



Moviestore Collection/REX/Shutterstock



Moviestore Collection/REX/Shutterstock



226. Indiana Jones' (Harrison Ford) Signature Fedora Ω

RAIDERS OF THE LOST ARK (1981)

Indiana Jones' (Harrison Ford) signature fedora from Steven Spielberg's action-adventure classic *Raiders of the Lost Ark*. As iconic as the character himself, the hat worn by Indiana Jones is a globally recognised cinematic treasure. Worn extensively by Harrison Ford, this fedora screen-matches numerous scenes throughout the film, and can be identified due to unique folds in the bow on the ribbon and specific wear and distressing on the felt.

Created by Herbert Johnson Hat Company, the fedora was carefully designed by costume designer Deborah Nadoolman, who worked with Spielberg and producer George Lucas to find a look that harked back to classic adventure heroes.

Made of rabbit felt, the fedora features a dark brown ribbon and a leather sweatband that is imprinted with the Herbert Johnson Hat Company name. The hat is marked a size 7 ¼ (size 58 European). The piece was issued to the production in new condition, before being distressed to achieve a worn look. According to Nadoolman, the fedora was sat upon, wrung repeatedly and treated with bleach and dust to age it. The hat's inner sweatband is autographed in black marker by Harrison Ford; the signature was obtained after production by a previous owner.

This fedora screen-matches numerous shots and sequences throughout the film, including several filmed at Elstree Studios, such as the Raven Bar sequence, the Well of Souls sequence and the Bantu Wind cabin sequence. It also screen-matches sequences filmed in Tunisia, including the Cairo street pursuit, the Tanis

dig and the truck chase. Ford wore this hat during such memorable moments as coming face to face with the king cobra in the Well of Souls, shooting the swordsman in Cairo, fighting the German mechanic under the flying wing and being dragged behind the truck during the truck chase. The unique identifying marks on the hat also allow it to be matched to numerous production photographs.

Raiders of the Lost Ark was nominated for nine Academy Awards®, including Best Picture and Best Director, and won five, including Best Art Direction and Best Visual Effects. Harrison Ford won a Saturn award for his portrayal of Indiana Jones. Indiana Jones was named the number two hero of all time on AFI's "100 Heroes and Villains" list, and *Raiders of the Lost Ark* was named the 10th most thrilling film in the first century of cinema. It was selected by the US Library of Congress for preservation in the National Film Registry. On a list of the 500 Greatest Movies of All Time, Empire magazine ranked *Raiders* number two. It has been cited by numerous film-makers as an inspiration on their careers.

Paired with the fedora are 14 photographs (vintage and modern) and lobby cards for the film showing Harrison Ford wearing the hat. The lot shows some wear due to production use and age, but the hat remains in very fine condition.

Dimensions: 33 cm x 30.5 cm x 15 cm (13" x 12" x 6")

£200,000-300,000



228. Nilo Rodis-Jamero Hand-Drawn Logo Concept Sketches Ω

RAIDERS OF THE LOST ARK (1981)

A set of Nilo Rodis-Jamero hand-drawn logo concept sketches from Steven Spielberg's action-adventure classic *Raiders of the Lost Ark*. Nilo Rodis-Jamero served as assistant art director at Industrial Light & Magic during the filming of *Raiders of the Lost Ark* and drew up these logo concepts during the production.

The first sketch is drawn in graphite on sketch paper. It depicts Indiana Jones (Harrison Ford) with a torch held high above his head in front of a wall of hieroglyphs. The second piece is also rendered in graphite on sketch paper, but is cut to a smaller size and attached to another piece of paper. It shows Indiana Jones in front of a wall with his whip in his hand. Both pieces show signs of use, such as pinholes and attached pieces of tape, but the set remains in fine condition. Dimensions (largest): 29 cm x 23 cm (11" x 9")



Please note this lot is sold without copyright, reproduction rights, licensing agreements or any other type of legal releases.

£1,500-2,500

229. Harrison Ford Autographed Photograph M

INDIANA JONES AND THE TEMPLE OF DOOM (1984)

A photograph from Steven Spielberg's action-adventure *Indiana Jones and the Temple of Doom*, autographed by Harrison Ford.

This close-up portrait depicts Ford in character as the iconic Indiana Jones, wearing his signature fedora, leather bomber jacket and button-down shirt. The black-and-white photograph was signed during production by the actor in black marker pen across the bottom portion. The photograph shows minimal signs of wear and is in good overall condition with no discernible creasing. Dimensions: 25.5 cm x 20.5 cm (10" x 8")

£200-300

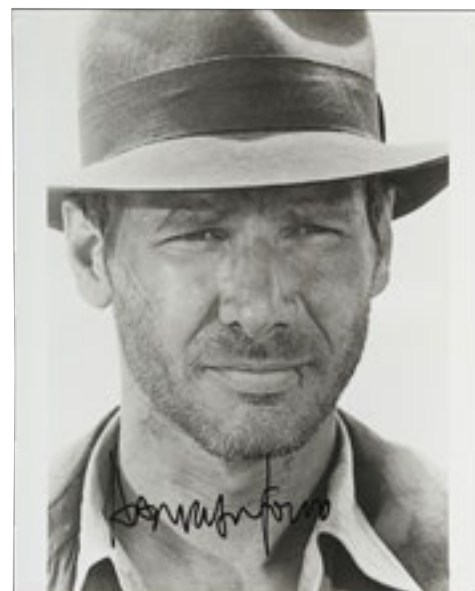

230. Temple Mine Miniatures M

INDIANA JONES AND THE TEMPLE OF DOOM (1984)

A set of miniatures from Steven Spielberg's adventure sequel *Indiana Jones and the Temple of Doom*. Indy (Harrison Ford), Willie (Kate Capshaw) and Short Round (Jonathan Ke Quan) escaped the temple mines in carts, closely pursued by Thuggee guards. The artists at ILM used a combination of live action interspersed with miniatures to create the mine-chase sequence.

The set consists of a resin barrel, plastic oil can and wicker basket, all painted shades of brown. The paint has begun to flake in places and there is a crack in the oil can, but they remain in otherwise good condition.

Dimensions (barrel): 6 cm x 6 cm x 10 cm (2 1/2" x 2 1/2" x 4")

£500-700



231. Banquet Beetle †Δ

INDIANA JONES AND THE TEMPLE OF DOOM (1984)

A banquet beetle from Steven Spielberg's action adventure *Indiana Jones and the Temple of Doom*. Willie Scott (Kate Capshaw) and her fellow dinner guests were served the bugs during the infamous banquet scene, while Indiana Jones (Harrison Ford) attempted to solve the mystery surrounding Pankot Palace and the missing village children.

Made from latex, the stag beetle features a detailed shell, spindly plastic legs and pincers. The insect is painted with a black gloss finish, while the underside is painted in brown tones. Showing signs of production use including paint wear, the beetle is fragile from age and should be handled with care. Dimensions: 14 cm x 11 cm x 3 cm (5 1/2" x 4 1/2" x 1 1/4")

£800-£1,200



232. 2nd Unit Clapperboard Ω

INDIANA JONES AND THE TEMPLE OF DOOM (1984)

A 2nd unit clapperboard from Steven Spielberg's action adventure *Indiana Jones and the Temple of Doom*. Used by the 2nd Unit during filming, the slate is made of wood, with a clapperstick affixed to the top. Six outlined boxes divide the piece into fields for "prod.," "director," "cameraman," "slate," "take" and "date."

The production title "Indy II" is painted in white across the top and the names of 2nd Unit director Mickey Moore and cameraman Paul Beeson are painted in their

respective boxes. The slate and take fields on the piece display faded notation, which was applied using white chalk during filming. Written in chalk at the bottom of the clapperboard is the last date of use, "6-5-83." Signs of production use are present on the piece, including scuff marks to the wood and light wear to the paint. Dimensions: 39 cm x 25 cm x 2 cm (15 1/4" x 13 3/4" x 3/4")

£6,000-8,000

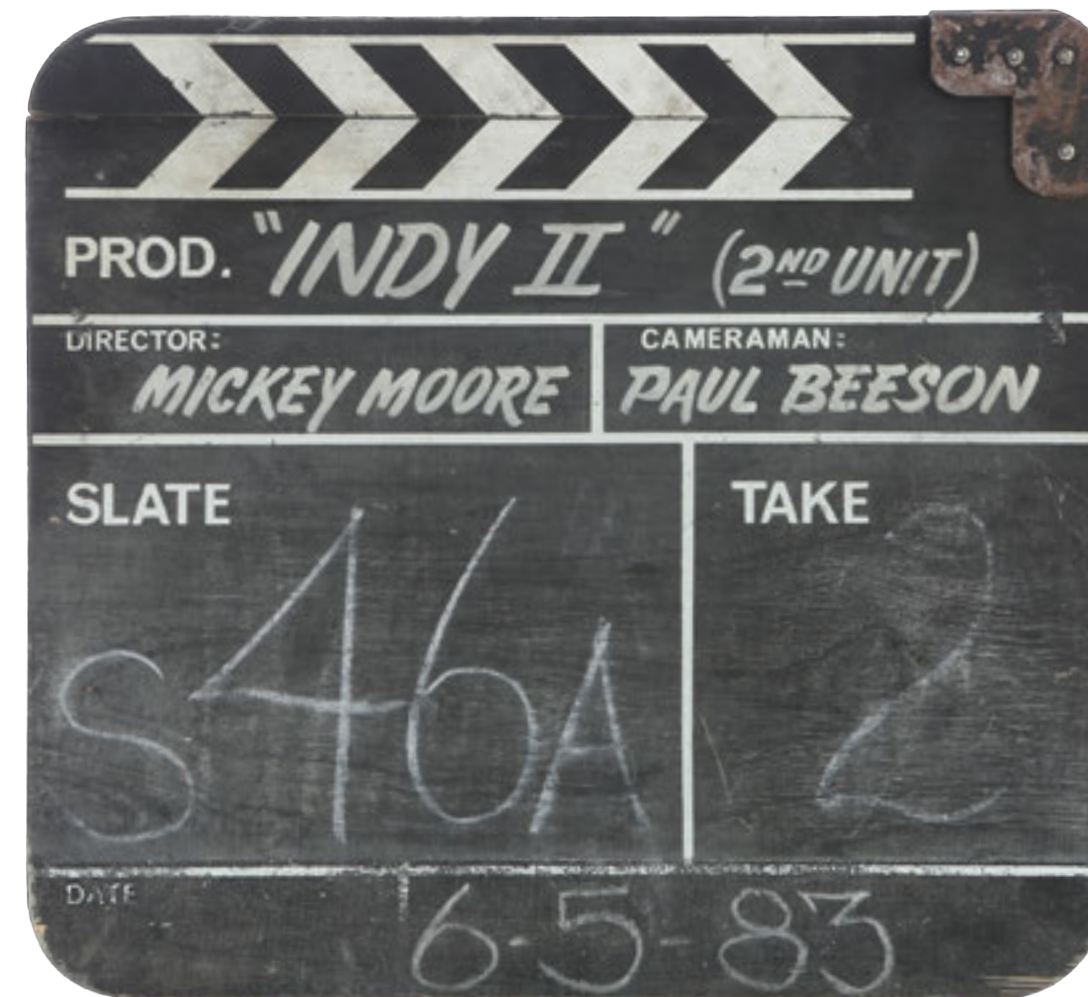

233. SFX Banquet Snake Platter M

INDIANA JONES AND THE TEMPLE OF DOOM (1984)

The special effects banquet snake platter from Steven Spielberg's action adventure *Indiana Jones and the Temple of Doom*. The astonishing "Snake Surprise" platter was served during the feast at Pankot Palace as Indiana Jones (Harrison Ford) questioned Chatter Lal (Roshan Seth) about the Thuggee cult. The large boa constrictor screen-matches to the scene in which Willie Scott (Kate Capshaw) watches in awe as it is cut open and live eels squirm out. Raj Singh, who played the young Maharaja, found this scene very troubling as he had a dislike for eels, even though it was supposed to be his character's favourite delicacy.

Constructed from resin and fibreglass, the snake features a cut-out section (made from foam latex) to the front, revealing eleven eels inside. It has been realistically painted with a high level of detail and is coiled around a hammered aluminium tray and secured by four spikes. The tray displays a pattern of circles around its rim.

The film, which won an Academy Award® for Best Visual Effects, is renowned for its use of special effects — this platter being an example of the work which earned the film that accolade. It contains a complex network of cables and components which extend under the base of the tray and were fed through the banquet table. This

allowed the special-effects crew to control the small mechanical creatures inside at the moment the snake was cut open, causing the real eels to spill out and create the illusion of writhing snake innards.

The snake platter is displayed on a custom-made black wooden mount to hide the mechanisms beneath. Accompanying it is an official collector's edition book featuring behind-the-scenes information about the film. Over time, the front section of snake has become fragile, with the foam becoming brittle and the mechanisms showing signs of corrosion. The paint finish also shows minor chips.

Dimensions (displayed): 60 cm x 83 cm x 76 cm (24 1/2" x 32 3/4" x 30")

This item contains electrical components. While every effort is made to describe them accurately, no guarantee or warranty is made as to functionality, lifespan or safety of those components. It is entirely incumbent on the new owner to satisfy themselves as to their safe use and maintenance.

£10,000-20,000

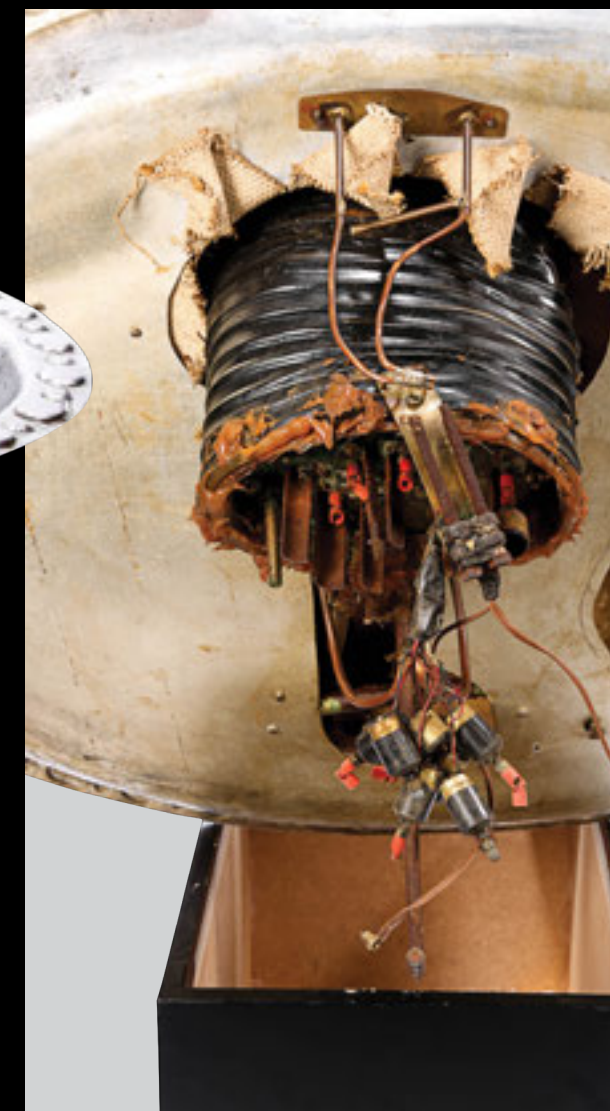



234. Hero Aluminium Thuggee Sword M

INDIANA JONES AND THE TEMPLE OF DOOM (1984)

A hero Thuggee sword from Steven Spielberg's action adventure *Indiana Jones and the Temple of Doom*. The cult guards, worshippers of Kali, carried their swords throughout the film, notably seen towards the end of the film when they attacked Indiana Jones (Harrison Ford) and herded him onto the rickety rope bridge.

Made to be lightweight, the sword consists of a polished aluminium blade with a cast resin grip. The grip displays a black, faux-gold and silver paint finish with a small brass nut-and-bolt fastening. The blade is blunted to ensure safety during use on set. It shows some wear from production use and time spent in storage, including paint chips on the handle and scratches along the length of the blade.

Dimensions: 105 cm x 5.5 cm x 3.5 cm (41 1/4" x 2 1/4" x 1 1/2")

£3,000-5,000



235. Thuggee Sword Ω

INDIANA JONES AND THE TEMPLE OF DOOM (1984)

A Thuggee sword from Steven Spielberg's action adventure *Indiana Jones and the Temple of Doom*. Mola Ram's (Amrish Puri) Kali-worshipping cultists carried their swords throughout the film, notably when they trapped Indiana Jones (Harrison Ford) on a rickety rope bridge.

The metal sword consists of a polished aluminium blade with an ornate grip that resembles a snarling tiger's head. The blade is blunted to ensure safety during use on set. It shows some wear from production use and time spent in storage, with the tiger pommel on the grip bent forward, causing a shortened handle. The piece remains in fine overall condition.

Dimensions: 87.5 cm x 10 cm x 3 cm (34 1/2" x 4" x 1 1/4")

£1,500-2,000

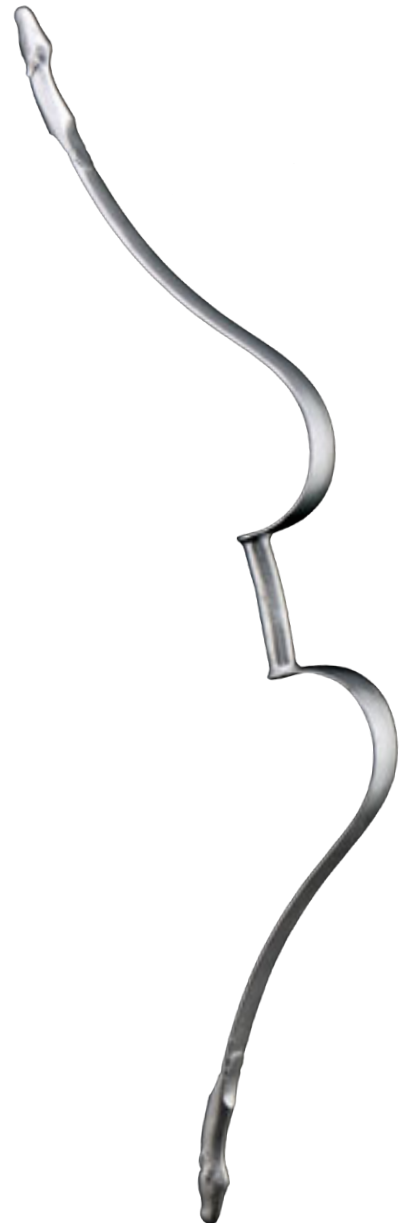

236. Thuggee Bow Ω

INDIANA JONES AND THE TEMPLE OF DOOM (1984)

A Thuggee bow from Steven Spielberg's action adventure *Indiana Jones and the Temple of Doom*. Mola Ram's (Amrish Puri) Kali-worshipping cultists used their bows to shoot arrows at Indiana Jones (Harrison Ford) while he dangled from a rickety rope bridge at the film's climax.

The lightweight bow is made of fibreglass, with tips resembling lamb's heads. The bow does not include a bowstring. It shows some wear from production use and time spent in storage, with minor scratches to the paint, but remains in very fine condition.

Dimensions: 105.5 cm x 21.5 cm x 4 cm (41 1/2" x 8 1/2" x 1 1/2")

£1,500-2,000

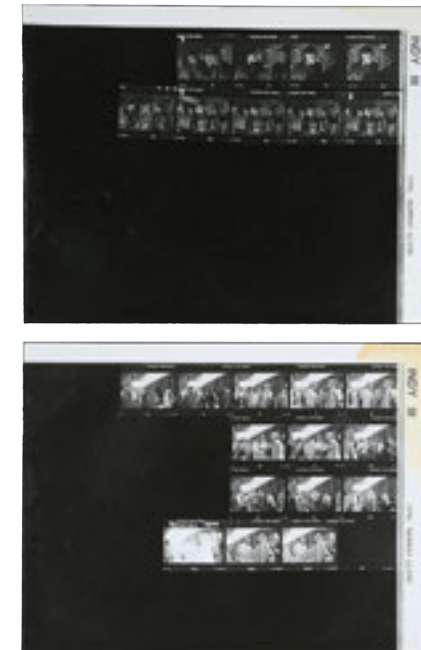

237. Pair of Contact Sheets M

INDIANA JONES AND THE LAST CRUSADE (1989)

A pair of contact sheets from Steven Spielberg's action adventure *Indiana Jones and the Last Crusade*. Used by production staff to select press stills, the first sheet shows the scene in which Indiana Jones (Harrison Ford) and Professor Henry Jones (Sean Connery) are confronted by three Nazi soldiers in Castle Brunwald. The second sheet depicts Marcus Brody (Denholm Elliott) with Sallah (John Rhys-Davies) at Iskenderun station.

Each sheet is printed on glossy photographic paper displaying 23 contact prints, made directly from original negatives. The text "Indy III" is printed on the right side and both credit stills photographer Murray Close. One sheet displays discolouration, and minor scratches to the glossy paper are present on both sheets. Dimensions (each): 28 cm x 22 cm (11" x 8 3/4")

£100-200



238. Production-Used Clapperboard M

INDIANA JONES AND THE LAST CRUSADE (1989)

A production-used clapperboard from Steven Spielberg's action-adventure *Indiana Jones and the Last Crusade*. Made from wood, its hinged clapper sticks display the Panavision logo and serial number on the hinge plate. Labelled spaces are provided for production title, scene and take numbers, director, cameraperson and date. There are markers for day/night and interior/exterior shooting.

The production title "Indiana Jones III" heads the clapperboard in yellow print, with "S. Spielberg" in the director field and "D. Slocombe" in the camera field.

The printed date reads "9.19.88", with the name "Earl" at the bottom right corner.

Evidence of notes in chalk can be seen in the scene and take fields. The clapperboard is heavily used from production, with scuffed edges and scratched surfaces, faded paint on the clapper sticks and three pieces of tape adhered to the rear.

Dimensions: 2.5 cm x 28 cm x 24 cm (1" x 11" x 9.5")

£4,000-6,000

239. Artiste Door Sign M**INDIANA JONES AND THE LAST CRUSADE (1989)**

An artiste door sign from Steven Spielberg's action adventure *Indiana Jones and the Last Crusade*. This sign would have marked the various cast member's dressing rooms while on location and at the studios. Made from beige card, the door sign displays a black "Lucas Film UK Ltd" logo and the text "Indy 3 Artiste", all printed within a black border. There are signs of wear, including crease lines, marks from age and remnants of Blu Tack on the back.

Dimensions: 5.5 cm x 36 cm x 0.2 cm (2 1/4" x 14 1/4" x 1/4")

£300-500

**240. Mark Sullivan Hand-Painted "The Path of God" Matte Study Ω****INDIANA JONES AND THE LAST CRUSADE (1989)**

A Mark Sullivan hand-painted matte study of the third trial from Steven Spielberg's action adventure *Indiana Jones and the Last Crusade*. While taking the "Path of God" test, Indy encountered a perilous cavern with a hidden bridge in the Grail temple.

Illustrated by ILM matte artist Mark Sullivan, the hand-painted matte study is done on illustration board using acrylic paints, and shows Indy standing on a ledge before a great open chasm. Written at the bottom of the board is "AB 2/3" in ink and pencil.

Showing minor wear due to production use and age, the board remains in good condition. Dimensions: 25 cm x 12 cm (9 3/4" x 4 3/4")

Please note this lot is sold without copyright, reproduction rights, licensing agreements or any other type of legal releases

£3,000-5,000

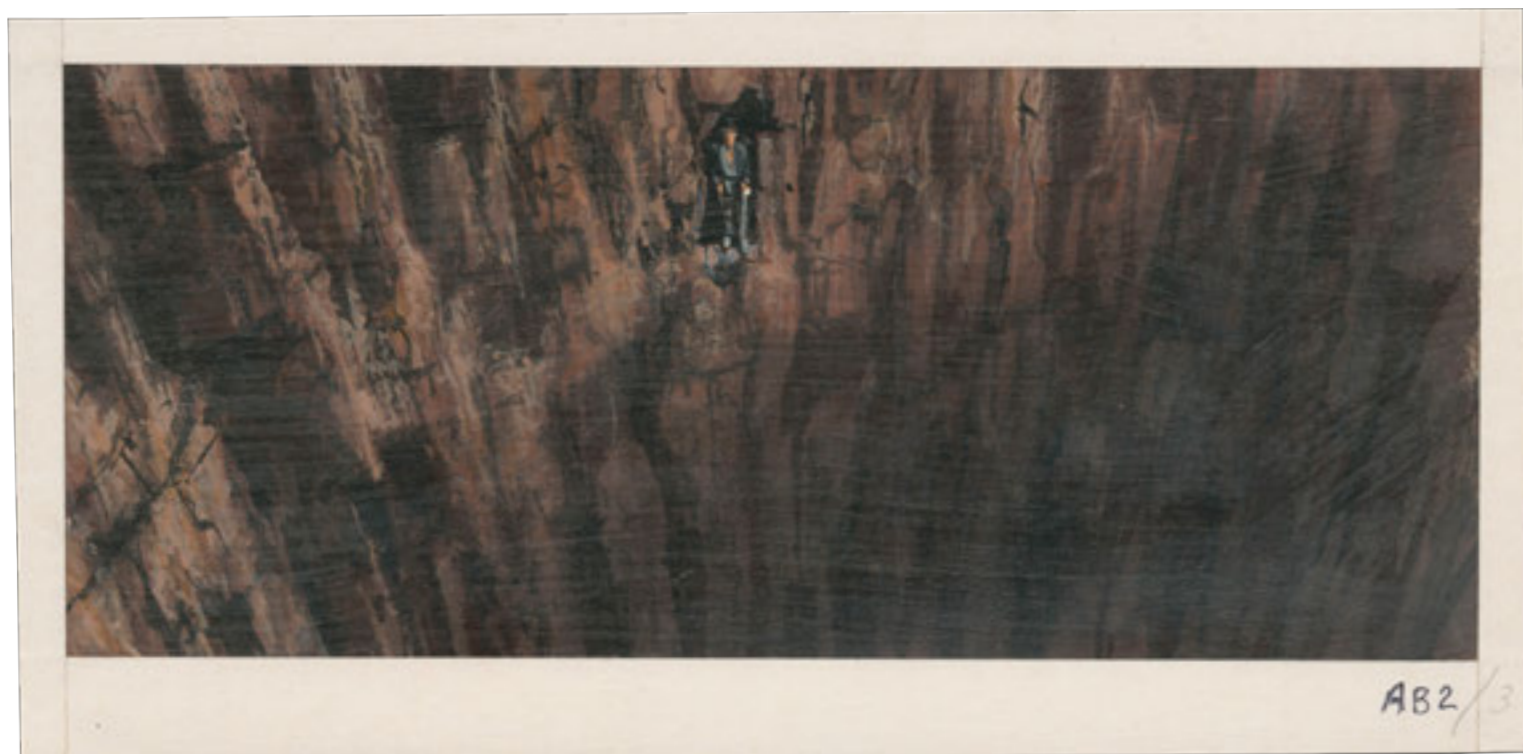
**241. Col. Hans Landa's (Christoph Waltz) Costume †Δ****INGLOURIOUS BASTERDS (2009)**

Col. Hans Landa's (Christoph Waltz) costume from Quentin Tarantino's *Inglourious Basterds*. Landa wore his costume when he attended the premiere of a Nazi propaganda film and attempted to strike a deal with the surviving Basterds, Lt. Aldo Raine (Brad Pitt) and Pfc. Smithson Utivich (B.J. Novak), in exchange for immunity for his war crimes. Waltz received the Academy Award® for Best Supporting Actor in his role as the merciless SS colonel.

The costume comprises a grey jacket and trousers, with a matching military cap. The suit jacket features assorted metal medals and awards, with embroidered patches secured to the arms and lapels. An embroidered silver belt is worn around the waist, featuring a green velvet lining and a round metal buckle and clasp. White piping runs down the side seam of the trousers, which fasten with a button fly. A white shirt, black tie and black elasticated braces are worn underneath the jacket, with a faux-gold medal worn around the neck, secured with a black cotton tie. The hat displays a metal Totenkopf skull and an eagle insignia, with a black velvet hat band and silver rope chin cord. A typed label is secured inside the cap, which reads "Stadartenfuhrer, H.Landa".

The belt and jacket have costumiers' labels, with the jacket and trousers displaying interior handwritten labels reading "173-45-85" and "Waltz 04-85, di, a11", respectively. The costume is displayed on a custom-made mannequin and base.

Dimensions (displayed): 38 x 64 cm 194 cm (15" x 25 1/4" x 76 1/4")

£6,000-8,000

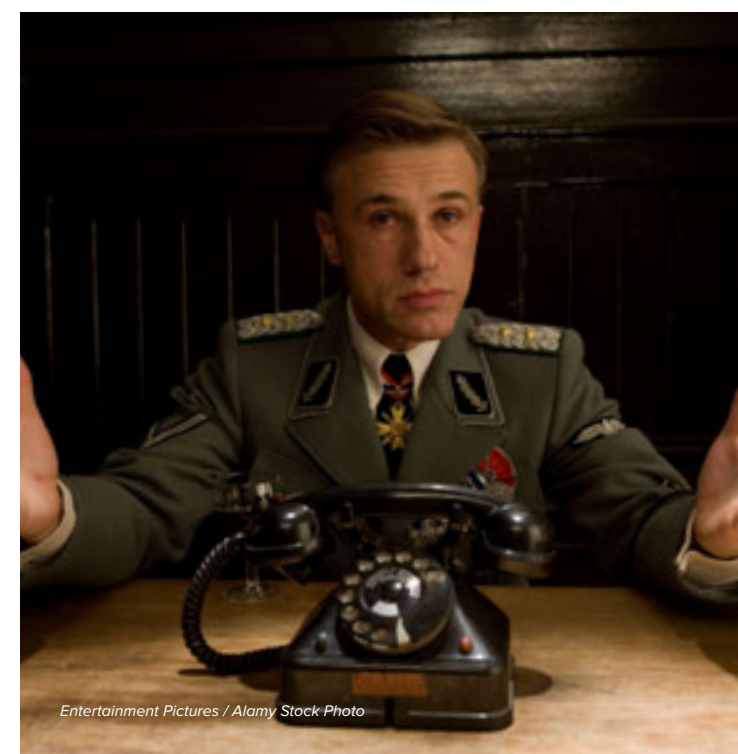

Entertainment Pictures / Alamy Stock Photo

242. Crew Jacket, Production Paperwork and Tom Cruise Autographed Placard M

INTERVIEW WITH THE VAMPIRE: THE VAMPIRE CHRONICLES (1994)

A crew jacket, production paperwork and Tom Cruise-autographed placard from Neil Jordan's centuries-spanning horror *Interview with the Vampire: The Vampire Chronicles*.

The leather crew jacket (size XXL) was issued to head of department personnel only, with this particular jacket given to Unit Production Manager Philip Kohler. The Warner Bros. shield is present on the left breast, with the film's title embroidered on the back. The archive of production paperwork includes a partial script (first 40 pages) and inter-office memos and faxes concerning, among other subjects, costume, shoot dates, locations, accommodation, special effects and catering. Completing the collection is a large card placard, which bears an inscription written by an unknown hand in felt-tip marker, thanking the cast and crew for their hard work during filming. The card is autographed at the foot by Tom Cruise. The giant autograph is over 30 cm long.

Dimensions (placard): 81 x 56 cm (31 ¾" x 22")

£400-600

243. Theatre des Vampires Prop Poster M

INTERVIEW WITH THE VAMPIRE: THE VAMPIRE CHRONICLES (1994)

A French prop poster from Neil Jordan's 1994 horror drama *Interview with the Vampire*. Posters for the mysterious Theatre des Vampires were seen when Louis (Brad Pitt) first left Armand's (Antonio Banderas) sinister playhouse, and later when he cowered outside the burning building as the sun rose.

Printed on heavy brown card, the poster has been styled to resemble 18th century Parisian lithography. "Theatre des Vampires" appears in large, spindly red lettering above the image of a black bat fluttering in a Gothic-style window. Billed as "La mort en cinq actes" ("Death in five acts"), the show is set at "9 h du soir". With very minor corner folds, the poster remains in excellent condition.

Dimensions: 89 cm x 63 cm x 0.1 cm (35" x 25" x ¼")

£400-600

244. Production-Used Script †Δ

INTERVIEW WITH THE VAMPIRE: THE VAMPIRE CHRONICLES (1994)

A production-used script from Neil Jordan's horror drama *Interview with the Vampire: The Vampire Chronicles*. Housed in a black binder, the script displays four cover pages crediting Anne Rice (screenplay) and Neil Jordan (director), along with dates which correspond with revisions contained within.

The script comprises 164 pages printed single-sided on white, goldenrod, yellow, pink, salmon and green pages that vary in size. Some pages feature various passages highlighted in yellow. Minor wear is present to the edges of multiple pages, and some pages are loose, displaying minor tears from production use.

Dimensions: 31.5 cm x 25 cm x 4 cm (12 ½" x 10" x 1 ¾")

£400-600

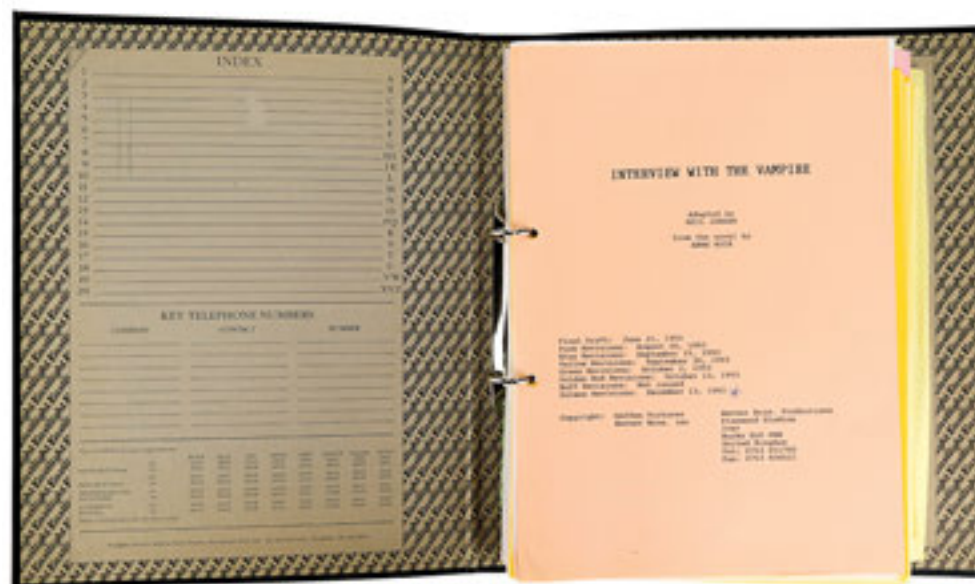

245. Lestat's (Tom Cruise) Waistcoat, Louis' (Brad Pitt) Theatres des Vampires Invitation and Drinking Glasses M

INTERVIEW WITH THE VAMPIRE: THE VAMPIRE CHRONICLES (1994)

Lestat's (Tom Cruise) waistcoat, Louis' (Brad Pitt) Théâtre des Vampires invitation and pair of drinking glasses from Neil Jordan's horror film *Interview with the Vampire: The Vampire Chronicles*. In New Orleans, Lestat filled his glass with the blood of a prostitute for the reluctant Louis to drink. Later, Lestat wore his waistcoat as Claudia (Kirsten Dunst) tricked him into drinking the blood of dead twins. After moving to Paris, Louis was given an invitation to the Théâtre des Vampires by fellow vampire Armand (Antonio Banderas).

The waistcoat is made from linen fabric with a pale blue front featuring an embroidered gold pattern throughout. A handwritten label sewn to the underarm reads "Lestat 10". Printed on thin cream card, the invitation reads "Theatres Des Vampires" printed in black text with the performance's date and time printed in French below. The wine glasses each feature a trumpet bowl with a beaded stem. The waistcoat displays light signs of wear, including blue-colour run on the back panel as result of age and use.

Dimensions (each glass): 10.5 cm x 10.5 cm x 19.5 cm (4 ¼" x 4 ¼" x 7 ¾"); (invitation): 11.5 x 8 cm (4 ½" x 3 ½")

£3,000-5,000

246. Obadiah Stane's (Jeff Bridges) Iron Monger Coveralls Ω

IRON MAN (2008)

Obadiah Stane's (Jeff Bridges) Iron Monger coveralls from Jon Favreau's superhero film *Iron Man*. Obadiah Stane stole Tony Stark's (Robert Downey, Jr.) arc reactor in order to place it inside his own Iron Monger suit. He wore coveralls when he placed the energy source inside his machine.

These coveralls are produced by Barrier-Wear and are size 44L. Made from an aramid and carbon fibre blend, these coveralls are noted as being fire resistant. The lot shows minimal signs of wear and is in very fine overall condition. Obtained through an official Marvel Studios Auction.

£1,500-2,000



247. "Proof That Tony Stark Has A Heart" Display Ring Backup †Δ

IRON MAN (2008)

A "Proof That Tony Stark Has A Heart" display ring backup from Jon Favreau's superhero film *Iron Man*. The original Repulsor Technology node was gifted with an engraved ring to Tony Stark (Robert Downey Jr) by Pepper Potts (Gwyneth Paltrow) and was smashed by Tony later in the film as he desperately replaced his chest piece.

"Proof That Tony Stark Has A Heart". Several pieces of double-sided tape have been applied to the back, allowing the ring to be easily adhered to the unit. The ring shows signs of wear, including marks and minor scratches.

Dimensions: 11.5 cm x 11.5 cm x 0.1 cm (4 1/2" x 4 1/2" x 1/4")

Made from acrylic, the ring is finished in faux silver to resemble metal and displays black engraved text reading,

£200-300

248. "Who Is The Ironman?" Chronicle Newspaper †Δ

IRON MAN (2008)

A "Who Is The Ironman?" (sic) Chronicle newspaper from Jon Favreau's superhero film *Iron Man*. Tony Stark (Robert Downey Jr.) read a newspaper and became impressed with the name *Iron Man* as he prepared to give a statement to the press.

printed in bold text along the top. An image of *Iron Man* features on the front, with several surrounding articles. The newspaper has a fold line at the center due to storage, and folds in the top right corner.

Printed on newspaper stock, the newspaper consists of two printed outer pages and 32 filler interior pages. The front cover displays the logo for The Chronicle newspaper, with the headline "Who Is The Ironman?"

Dimensions: 58 cm x 32 cm x 0.2 (23" x 12 3/4" x 1/4")

£400-600



249. Full-Scale Iron Man Replica Statue †

IRON MAN (2008)

A full-scale *Iron Man* replica statue made to promote Jon Favreau's superhero film *Iron Man*. The statue sees *Iron Man* taking an imposing stance, clad in the red-and-gold armour synonymous with the character. Made of fibreglass, it is presented on a display base that incorporates the movie title across the front, painted metallic grey. It remains in very good condition, with light wear.

Dimensions (displayed): 50 cm x 92 cm x 245 cm (19 3/4" x 36 1/4" x 96 1/2")

£500-£1,000



250. Tony Stark's (Robert Downey Jr.) Senate Hearing Suit Ω

IRON MAN 2 (2010)

Tony Stark's (Robert Downey Jr.) senate hearing suit from Jon Favreau's superhero sequel *Iron Man 2*. Tony wore his striped suit when he testified in a hearing before Senator Stern (Gary Shandling).

Made by David August, the bespoke suit includes a jacket, dress shirt, tie, handkerchief, and a pair of matching slacks. The dark striped jacket includes a lapel label that reads "Exclusively tailored for Tony Stark" and includes a lining featuring a print of the Stark family crest. Inside the right lapel pocket is a Marvel barcode sticker with the production code "IM2". Tony's shirt is also bespoke, with a hand-stitched label at the neck that reads "Tony Stark". The slacks include a David August typed label in the pocket, reading "R. Downey Jr. #21" and the date "3/20/2009". Accompanied by an official Marvel Studios certificate of authenticity.

£5,000-7,000

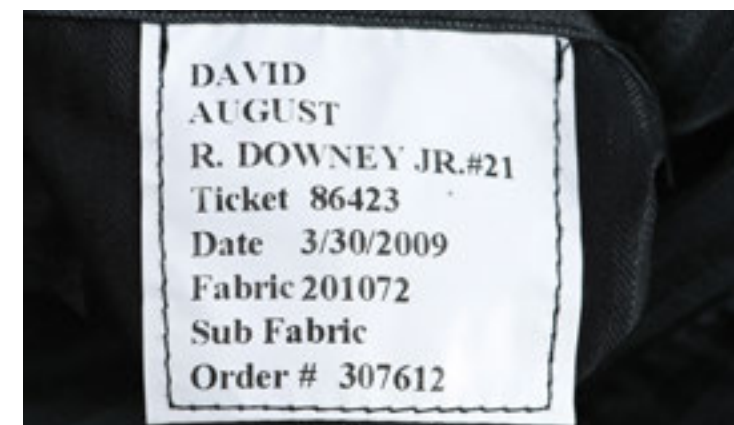

251. James Rhodes' (Terrence Howard) Air Force Uniform Ω

IRON MAN (2008)

James Rhodes' (Terrence Howard) Air Force uniform from Jon Favreau's superhero film *Iron Man*. "Rhodey" wore his uniform in numerous scenes, including his awards presentation to Tony Stark at Caesar's Palace, and later when he flew with Tony to, and from, Afghanistan.

The uniform is made by Bon Choix Couture with a bespoke shirt by Anto Distinctive Shirtmakers. The three-button coat is adorned with numerous rank pins, insignias, a ribbon rack and a name tag that reads "Rhodes". Rhodey's dress shirt is similarly dressed with pins and a name tag, and includes an Anto label stitched at the neck, which features Terrence Howard's initials. The costume also includes Rhodey's tie, undershirt, trousers and a belt. Accompanied by an official Marvel Studios certificate of authenticity.

£2,500-3,500



252. U.S. Air Force Hammer Drone Arm †Δ

IRON MAN 2 (2010)

A U.S. Air Force Hammer Drone arm from Jon Favreau's superhero sequel *Iron Man 2*. Parts of Air Force Hammer Drones were scattered across the ground in the aftermath of the battle scenes in which Tony Stark (Robert Downey Jr) and Lieutenant-Colonel Rhodes (Don Cheadle) defeated the drones.

The fibreglass drone arm features cast-in geometric detailing, complete with a robotic hand and a spray-painted white U.S Air Force logo. Finished in grey and blue paint, the arm has been heavily distressed to produce a battle-damaged appearance, including 'melted' portions, chips in the paint work and missing sections. The lot displays signs of production use, including visible pieces of glue and minor marks.

Dimensions: 94 cm x 31 cm x 30 cm (37" x 12 1/4" x 11 3/4")

£500-700



253. U.S. Marine Corps Hammer Drone Arm †Δ

IRON MAN 2 (2010)

A U.S. Marine Corps Hammer Drone arm from Jon Favreau's superhero sequel *Iron Man 2*. Parts of Marine Corps Hammer Drones were scattered across the ground in the aftermath of the battle scenes in which Tony Stark (Robert Downey Jr) and Lieutenant-Colonel Rhodes (Don Cheadle) defeated the drones.

Made from fibreglass, the drone arm displays cast-in geometric detailing, "Marines" spray-painted in white, a pointed loose saw blade and a separate foam robotic hand. Finished in dark grey and faux-silver paint, the piece has been heavily distressed to produce a battle-damaged appearance, including 'melted' portions, severed wiring and missing sections. The lot displays signs of production use, including visible pieces of glue and paint wear. Dimensions: 101 cm x 30 cm x 25 cm (39 3/4" x 12" x 10")

£500-700



254. Hammer Drone Light-Up RT Unit †Δ

IRON MAN 2 (2010)

A Hammer Drone Light-Up Repulsor Technology (RT) Unit from Jon Favreau's superhero sequel *Iron Man 2*. Ivan Vanko (Mickey Rourke) designed miniaturised arc reactors for Justin Hammer's (Sam Rockwell) drones, which went on to wreak havoc at the Stark Expo in New York.

Constructed from resin, the RT unit has been finished in shades of metallic faux-silver paint and displays a circular-shaped white acrylic section at the centre. Seven LED lights are fitted inside, which illuminate the acrylic pane. A transparent section is adhered to the back and several visible wires run underneath to the rear. The lot displays minor paint wear and comes presented on a custom-made stand, complete with a button on the back which illuminates the unit when pressed.

Dimensions (on display): 14 cm x 12 cm x 22cm (5 1/2" x 4 3/4" x 8 3/4")

As this item contains electronic components, every effort has been made to describe them accurately. However, no guarantee or warranty is made as to functionality, lifespan or safety of those components. It is entirely incumbent on the new owner to satisfy themselves as to their safe use and maintenance.

£2,000-3,000

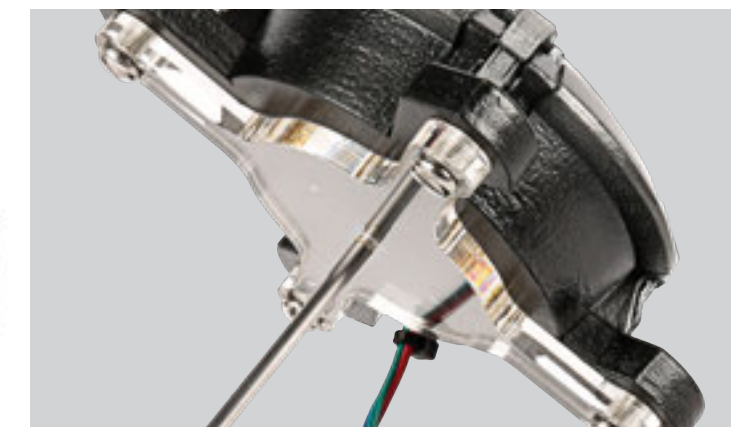



255. Mike Zeck and Phil Zimelman Hand-Painted Cover Artwork Ω

IRON MAN SUPER THRILLER: STEEL TERROR (1996)

Hand-painted cover artwork by Mike Zeck and Phil Zimelman featuring Iron Man and Ultron facing off for the *Iron Man Super Thriller: Steel Terror* novel by Dean Wesley Smith. The book cover artwork shows Iron Man engaging in a battle with Ultron over a snowy landscape.

Mike Zeck originally pencilled the artwork for this cover on a separate board and then re-pencilled the image on a larger sheet of illustration paper so that it could be painted in full colour by Phil Zimelman. This painted illustration paper has been mounted on a sheet of foamcore board. Zeck and Zimelman's signatures appear below the snowy mountain facility.

Included with the lot is a reference copy of the novel in which this art was originally published. The board shows paint splotches on the taped boarder, but the artwork remains in very fine condition.

Dimensions: 53 cm x 34 cm x 1 cm (21" x 13 1/4" x 1/4")

Please note this lot is sold without copyright, reproduction rights, licencing agreements or any other type of legal release.

£2,000-2,500



256. Mike Zeck Hand-Drawn Pencil Cover Artwork Ω

IRON MAN SUPER THRILLER: STEEL TERROR (1996)

Hand-drawn pencil cover artwork by Mike Zeck featuring Iron Man and Ultron facing off for the *Iron Man Super Thriller: Steel Terror* novel by Dean Wesley Smith. The book cover artwork shows Iron Man engaging in a battle with Ultron over a snowy landscape.

The pencilled cover artwork is drawn by Mike Zeck on Bristol board and shows the artist's signature at the bottom. Included with the lot is a reference copy of the novel in which this art was originally published. The artwork is in very fine condition.

Dimensions: 43 cm x 28 cm (17" x 11")

Please note this lot is sold without copyright, reproduction rights, licencing agreements or any other type of legal release.

£500-700

257. Enzo Sciotti Signed Hand-Painted Concept Poster Art M

JAMES BOND: DR NO (1962)

A hand-painted poster artwork from Terence Young's spy film *Dr. No*. Designed and executed by Italian artist Enzo Sciotti, the painting features a full-body view of James Bond (Sean Connery) standing in his iconic pose with his gun alongside a scantily clad Honey Ryder (Ursula Andress) and two naked women. Surrounding them are headshots of Bond and Ryder in various stages of completion.

The artwork consists of a mixture of pen-and-ink drawings and watercolour painted elements, presented on thick white card. It is signed in black ink by Sciotti on the bottom left corner. The reverse displays a pencil-drawn concept for an Italian poster featuring the film *Escape From The Bronx*; which is also signed by the artist. The painting shows some edge wear and creases on all four corners and three pinholes along the top edge. Dimensions: 31.5 cm x 45 cm (12 1/2" x 17 3/4")

Please note this lot is sold without copyright, reproduction rights, licencing agreements or any other type of legal releases.

£1,500 – 2,500



258. Q's (Desmond Llewelyn) Touring Briefcase Gadget Knife, Autographed Photo and Book †Δ

JAMES BOND: FROM RUSSIA WITH LOVE (1963)

Q's (Desmond Llewelyn) touring briefcase gadget knife from Terence Young's Bond movie *From Russia with Love*. The head of the Q branch provided Bond (Sean Connery) with an attaché case which contained a throwing knife in a hidden compartment.

Desmond Llewelyn attended many Bond-themed events and exhibitions, taking a special-effects version of the briefcase seen in the film. This particular knife was custom-made to slot into a compartment on the left side of Llewelyn's touring briefcase.

The knife consists of a blade which features the etched text "Left Side" and a handle with a wooden grip. The majority of the faux-silver paint has worn away over time and the blade displays minor scratches. The lot includes an autographed photo of Desmond Llewelyn with the briefcase showcasing the knives sticking out, and an autographed copy of *Q: The Biography of Desmond Llewelyn* (Sandy Hernu, SB Publications, 2000). Dimensions (blade): 20.5 cm x 4 cm x 0.5 cm (8 1/4" x 1 3/4" x 1/4"); (book): 24.5 cm x 17 cm x 1.5 cm (9 3/4" x 6 3/4" x 3/4"); (still): 26 cm x 20 cm (10 1/4" x 8")

£1,500-2,500

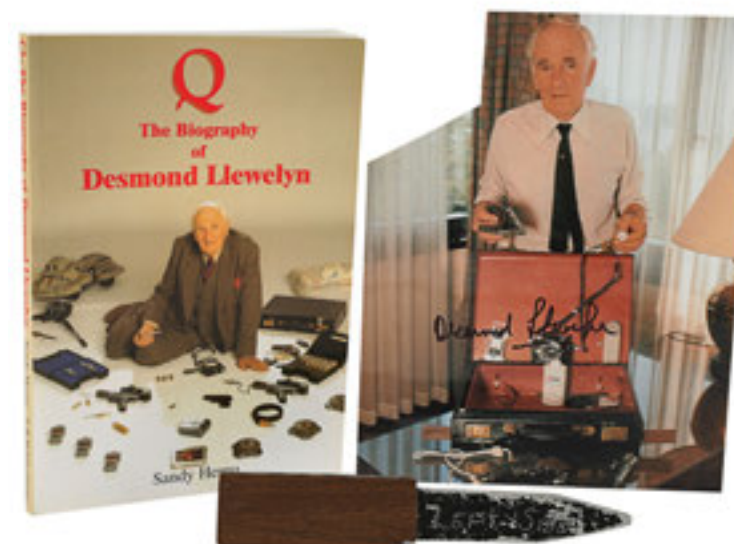

259. Gyrojet Rifle M

JAMES BOND: YOU ONLY LIVE TWICE (1967)

A Gyrojet rifle from Lewis Gilbert's Bond movie *You Only Live Twice*. Rifles were part of the weaponry at Tanaka's (Tetsurô Tanba) ninja camp and were carried by the ninjas as they helped Bond (Sean Connery) infiltrate Blofeld's (Donald Pleasence) volcanic lair.

The custom-made rifle is based on an MBA Gyrojet and is constructed from fibreglass. The majority of the weapon is finished in brown to replicate the appearance of wood, and the trigger and barrel are finished in black to resemble metal. The rifle displays minor wear and cracks on the paint finish, with marks from production use. Dimensions: 83 cm x 5 cm x 16 cm (32 3/4" x 2" x 6 1/4")

£800-1,200





260. James Bond (Roger Moore) Scuba Diver Model Miniature M

JAMES BOND: FOR YOUR EYES ONLY (1981)

A James Bond (Roger Moore) scuba diver model miniature from John Glen's Bond movie *For Your Eyes Only*. Miniature versions of Bond and Melina (Carole Bouquet) in their diving suits were used for shots in which the pair narrowly escaped the exploding shipwrecked St Georges with the ATAC device intact.

Created by renowned visual effects supervisor Derek Meddings, the 007 figure is wearing a yellow plastic diving suit decorated with utility straps, and is mounted on a metal base. It is carrying a blue resin torch and the ATAC device, with button detailing applied. Made of resin, the helmet features a transparent section and faux-silver breathing apparatus, with tubes connecting to a wooden backpack. The model's face is visible through the helmet, with painted facial features, and the silicone hands show cast-in nail detailing. The backpack contains electronic components, with exposed wiring running from it down to the torch, which would have illuminated. The electronics remain untested. Several marks are present on the diving suit, and the model and base show signs of paint wear from production use.

Dimensions: 38 cm x 13 cm x 22 cm (15" x 5 1/4" x 8 3/4")

This item contains electronic components. While every effort has been made to describe them accurately, no guarantee or warranty is made as to the functionality, lifespan or safety of those components. It is entirely incumbent on the new owner to satisfy themselves as to their safe use and maintenance.

£3,000-5,000



261. James Bond's (Roger Moore) Sunglasses †Δ

JAMES BOND: A VIEW TO A KILL (1985)

James Bond's (Roger Moore) sunglasses from John Glen's Bond movie *A View to a Kill*. Bond wore his sunglasses during the film's pre-credits sequence as he braved the tundra of Siberia in search of a Soviet microchip.

Made by the German ski-clothing manufacturer Bogner — which provided ski wear for Bond in multiple films through the 1970s and '80s — the sunglasses feature white plastic frames, black metal arms and grey-tinted, Bogner-branded plastic lenses. The glasses display some marks to the inside of the lenses from storage and the frames are slightly discoloured as a result of age. However, they remain in very good overall condition. Dimensions (closed): 6.5 cm x 15.5 cm x 2 cm (2 1/2" x 6 1/4" x 3/4")

£3,000-5,000



262. HK21 Boat-Mounted Gun †Δ

JAMES BOND: THE WORLD IS NOT ENOUGH (1999)

A Heckler & Koch HK21 boat-mounted gun from Michael Apted's Bond movie *The World Is Not Enough*. A HK21 featured in one of the film's most exciting pursuit sequences, mounted to the back of the speedboat driven by the Cigar Girl (Maria Grazia Cucinotta) as she was chased by Bond (Pierce Brosnan) down the Thames.

This version of the weapon was made for the stunt sequence in which Bond drove into the speedboat, breaking the gun from its mounting. Cast from dense rubber, the gun is a heavily modified version of a HK21 machine gun with an additional plastic faux scope and PSG-1 stock.

Finished in black, brown and white paint, the gun features a textured grip and comes attached to a mount. The mounted weapon shows signs of production use, including minor scratches and paint wear on the scope, and the lot is accompanied by a Bapty Ltd letter of authenticity. Dimensions: 136 cm x 24 cm x 32 cm (53 1/2" x 9 1/2" x 12 3/4")

Ownership of this item is restricted for U.K. residents to registered re-enactors, galleries, or individuals in film, television or theatre production. Please enquire for further details. It is solely the buyer's responsibility to check, prior to bidding, the legal status of this prop within their own country and its importation therein.

£2,000-3,000



263. Renard's (Robert Carlyle) Nuclear Silo Jacket M

JAMES BOND: THE WORLD IS NOT ENOUGH (1999)

Renard's (Robert Carlyle) nuclear silo jacket from Michael Apted's Bond movie *The World Is Not Enough*. Renard wore his Nuclear jacket at the underground ICBM site, where Agent 007 (Pierce Brosnan) attempted to stop the Russian extremist and his henchmen from stealing an active nuclear warhead.

The jacket is made from navy blue cotton, with reflective strips attached on both sleeves and a zip running down the front. An embroidered Russian star insignia with Greek lettering decorates the garment, and an Angels Costumiers label reading "Robert Carlisle, Jan 1999, NO1" is adhered to the lining at the neckline. The emblem on the front pocket has become partially detached and the jacket displays marks from production use.

£600-800



264. \$100,000 Casino L'or Noir Chip M

JAMES BOND: THE WORLD IS NOT ENOUGH (1999)

A \$100,000 Casino L'or Noir chip from Michael Apted's Bond movie *The World Is Not Enough*. High-value chips were used by the glamorous clientele at Casino L'or Noir, owned by Valentin Zukovsky (Robbie Coltrane). Bond (Pierce Brosnan) visited the casino to retrieve information on the Russian terrorist Renard (Robert Carlyle).

Made of plastic, the gold-coloured chip displays an ornate, printed black design, which features a side-profile image of Zukovsky, card house symbols, the name

of the casino and the denomination of the chip. The chip shows signs of wear due to production use, including light scratches and minor marks on the plastic.

Dimensions: 14 cm x 6.5 cm x 0.5 cm (5 1/2" x 2 1/2" x 1/4")

£400-600



265. \$10,000 Casino L'or Noir Casino Chip †Δ

JAMES BOND: THE WORLD NOT ENOUGH (1999)

A \$10,000 Casino L'or Noir chip from Michael Apted's Bond movie *The World Is Not Enough*. High value chips were used by the clientele at Casino L'or Noir, owned by ex-KGB agent Valentin Zukovsky (Robbie Coltrane). James Bond (Pierce Brosnan) visited the casino to retrieve information on the Russian terrorist Renard (Robert Carlyle).

Made from plastic, the silver-coloured chip displays an ornate printed black design which features a side profile image of Zukovsky, card house symbols, the

name of the casino and the denomination of the chip. There are signs of wear from use on production, including minor scratches and marks on the plastic.

Dimensions: 14 cm x 6.5 cm x 0.5 cm (5 1/2" x 2 1/2" x 1/4")

£400-600



266. Victor-Class Submarine Model Miniature M

JAMES BOND: THE WORLD IS NOT ENOUGH (1999)

A Victor-class submarine model miniature from Michael Apted's Bond movie *The World Is Not Enough*. James Bond (Pierce Brosnan) and Dr. Christmas Jones (Denise Richards) successfully controlled the submarine's detonation during the film's climatic scenes, after terrorist Renard (Robert Carlyle) unsuccessfully inserted a plutonium rod in the submarine's reactor.

Constructed by Turks Shipyard, this large remote-control model miniature was used for underwater exterior shots of the submarine. Based on the design of vintage Soviet Victor-class nuclear submarines, this version has no capacity for a crew and would have been controlled by one person wearing full diving equipment with breathing apparatus.

Weighing approximately five tonnes, the model comprises an internal frame constructed from a combination of plywood and metal, with a black fibreglass exterior shell featuring multiple small square faux-ballast tank ports. Various features adorn the outside of the submarine, including eight oval-shaped torpedo launchers

at the front, moveable sail planes, a rudder, a metal brass-coloured propeller, an opening hatch at the top and three winch points for transportation purposes. Four air tanks, a hydraulic control mechanism and ballast tanks are housed inside the piece, with an engine fitted towards the back and the base of the model is hollow.

Due to being stored outside for many years, the submarine displays signs of wear, including paint wear, missing decals and signs of the wood weakening at the top. The model is missing aerials, plates at the stern and the submarine's propeller cap.

Dimensions: 1,450 cm x 248 cm x 260 cm (571" x 97 3/4" x 102 1/2")

As this item is oversized it will require a specialist shipping service with additional costs. Please contact us prior to purchasing to request a quote.

£10,000–20,000



1450 cm / 570.8 in





267. Main Cast and Crew Chairbacks †Δ

JAMES BOND: DIE ANOTHER DAY (2002)

A set of chairbacks from Lee Tamahori's Bond movie *Die Another Day*. These chairbacks were fitted onto director-style chairs, used by cast and crew members who worked on the production.

The lot comprises five chairbacks featuring the names of Pierce Brosnan, Halle Berry, Judy Dench and producers Barbara Broccoli and Michael G. Wilson. Made of black canvas fabric, the five chairbacks display various visible lines of stitching and the names embroidered in white. The set displays marks, loose threads, discolouration on some of the embroidered names and minor wear from production use.

Dimensions (cast members): 18 cm x 57 cm x 0.2 cm (7 ¼" x 22 ½" x ¼"); (crew members): 21 cm x 57.5 cm x 0.5 cm (8 ¼" x 22 ¾" x ¼")

£600-800

268. James Bond's (Pierce Brosnan) Floral Shirt †Δ

JAMES BOND: DIE ANOTHER DAY (2002)

James Bond's (Pierce Brosnan) floral shirt from Lee Tamahori's Bond movie *Die Another Day*. The garment screen matches to the scenes in Cuba, where Bond tracked Zao (Rick Yune) to the island of Isla Los Organos and had his first encounter with NSA agent Jinx Johnson (Halle Berry).

The shirt is made by Italian tailor house Brioni, which created bespoke garments for several Bond films after being introduced to the franchise by costume designer Lindy Hemming. Made from textured blue cotton, the shirt shows an embroidered floral pattern and features six white buttons attached to the front. The left breast features a pocket, and a Brioni label with "1" handwritten in black is adhered to the inside. The shirt displays light plucks from production use and loose threads on the buttonholes. The lot is accompanied by a Brioni letter of authenticity.

£1,500-2,500



269. James Bond's (Pierce Brosnan) Shoulder Holster †Δ

JAMES BOND: DIE ANOTHER DAY (2002)

James Bond's (Pierce Brosnan) shoulder holster from Lee Tamahori's Bond movie *Die Another Day*. Bond wore his holster during a virtual-reality skills test in which he shot several simulated terrorists and saved M (Judi Dench).

Weapons and equipment for many Bond films were provided by the armourers Bapty & Co. Lined with brown suede fabric, the black leather rig has a popper fastening at the bottom, allowing a Walther P99 pistol to be securely attached within. The holster features a leather strap with plastic adjustable buckles, a long black utility strap and a thick piece of elastic with a hidden adhered metal clip. Signs of wear are present, including minor scratches and light wear to the leather and metal components. The lot is accompanied by a Bapty letter of authenticity.

Dimensions (holster): 21 cm x 17 cm x 4 cm (8 ¼" x 6 ¾" x 1 ½")

£2,000-3,000

270. \$1,000,000 Montenegro Casino Royale Chip Ω

JAMES BOND: CASINO ROYALE (2006)

A \$1,000,000 casino chip from Martin Campbell's *Casino Royale*. Casino chips were used during the high-stakes poker game between James Bond (Daniel Craig) and Le Chiffre (Mads Mikkelsen) at the *Casino Royale* in Montenegro.

The casino chip is made of pearlescent blue plastic with gold-and-red accents at the centre. "*Casino Royale* \$1,000,000 Montenegro" is printed on both sides in a gold-and-black font. The chip displays light scratches, but remains in very good condition.

Dimensions (casino chip): 11.5 cm x 8 cm x 1 cm (4 ½" x 3 ¼" x ¼")

£800-1,200



271. James Bond's (Daniel Craig) Sunglasses M

JAMES BOND: QUANTUM OF SOLACE (2008)

James Bond's (Daniel Craig) sunglasses from Marc Forster's *Quantum of Solace*. Bond wore his sunglasses when he visited René Mathis (Giancarlo Giannini) in Italy to ask him to accompany him to Bolivia, and in the Atacama Desert before he confronted Dominic Greene (Mathieu Amalric).

Made by Tom Ford, the aviator-style sunglasses feature a brushed metal frame with blue-tinted lenses. The arms display black leather temple tips with the brand logo printed on both sides. The sunglasses are accompanied by an autographed

photograph of Daniel Craig as James Bond, featuring an image of him wearing his sunglasses. The lot is provided with a Certificate of Authenticity from EON Productions.

Dimensions (sunglasses): 14.5 cm x 4.5 cm x 3 cm (5 ¾" x 1 ¾" x 1 ¼"); (photograph): 40.5 cm x 30.5 cm (16" x 12")

£3,000-5,000





272. Jason Vorhees' (Kane Hodder) Stunt Mask Ω

JASON X (2001)

Jason Vorhees' (Kane Hodder) stunt mask from James Isaac's horror sequel *Jason X*. After 400 years in cryosleep, the masked killer Jason returned to hunt students on a spaceship. Jason wore his traditional hockey mask in numerous scenes, until a heavily armed Kay-Em 14 (Lisa Ryder) blew up his head. This mask was made for the scene in which Kay-Em 14 blows up Jason's head, although as the shot was accomplished in the first take, there was no need to blow up additional masks.

Resembling a vintage hockey goaltender mask, the piece is made of rigid foam with leather straps. The mask is distressed by the production to display cast-in damage from Jason's many years of hunting teenagers. Leather straps are glued

in place, and do not include any attached hardware for fastening. Inside the mask is foam that has hardened due to age.

Accompanying the mask is a letter of authenticity from effects supervisor Bob Hall. The fragile mask shows wear due to production use and age, but remains in good condition.

Dimensions: 18 cm x 24 cm x 13 cm (7" x 9 1/2" x 5")

£6,000-8,000



273. Storyboards and Crew T-shirt M

JAWS (1975)

A set of storyboards and a crew T-shirt from Steven Spielberg's Academy Award®-winning blockbuster *Jaws*. The lot consists of 40 storyboards, eight black-and-white photographs, a biography of Lorraine Gary (Ellen Brody) with two photos attached, and a crew T-shirt.

The storyboard set depicts Brody (Roy Scheider), Quint (Robert Shaw) and Hooper (Richard Dreyfuss) attempting to capture the great white shark. Each page displays between one and three printed images with a description underneath.

The T-shirt is made from light blue cotton and features a black printed image of the shark showing off its sharp teeth, with the text "Jaws" situated underneath. Signs of wear are present, including slight discoloration on some of the storyboards and a minor fold in one corner of the biography. The T-shirt remains in an unworn condition and the lot is accompanied by a letter of authenticity. Dimensions (paperwork): 29 cm x 24 cm x 3 cm (11 1/2" x 9 1/2" x 1 1/4")

Please note this lot is sold without copyright, reproduction rights, licensing agreements or any other type of legal releases.

£2,000-3,000

274. John Wick's (Keanu Reeves) Kimber Warrior Handgun Ω

JOHN WICK: CHAPTER 2 (2017)

John Wick's (Keanu Reeves) Kimber Warrior handgun from Chad Stahelski's action sequel *John Wick: Chapter 2*. Pulled back into the criminal underworld to repay a debt, legendary assassin John Wick found himself targeted for permanent retirement. John Wick met with The Bowery King (Laurence Fishburne), who issued him a Kimber 1911, .45 ACP.

This airsoft gas blowback pistol is made of metal with a KimbPro II black finish. It includes a three-dot sight and a G-10 grip with a beavertail and speed bump for handling. Accompanying the lot is a signed letter of authenticity from executive producer Basil Iwanyk who noted the piece is a hero prop and was signed out for and used by Keanu Reeves during the production. The piece shows minor wear due to production use and remains in very fine condition.

Dimensions: 22 cm x 2.5 cm x 17 cm (8 3/4" x 1" x 6 3/4")

Ownership of this item is restricted for UK residents to those registered as re-enactors, galleries, or individuals in film, television or theatre production. Please enquire for further details. It is solely the buyer's responsibility to check, prior to bidding, the legal status of this prop within their own country and its importation therein.

£2,000-3,000





275. Production-Used Script, Clapperboard and Crew Items M

JUDGE DREDD (1995)

A script, clapperboard and crew items from the production of Danny Cannon's sci-fi action film *Judge Dredd*. The 109-page draft script is dated 25 July 1994, credited as written by Gary Goldman and Danny Cannon and bound in a black card folder. The wooden clapperboard features hand-painted details in white paint, with a strip of white tape across the bottom providing the last-used date "5/12/94".

The crew items comprise a blue fleece jumper (size L) with a zippered neck, two pockets and the film title embroidered in silver-coloured thread on the left breast; a grey T-shirt (size XL) with Dredd's (Sylvester Stallone) badge printed on the chest, the film logo on the reverse in black and silver, and the line "I AM THE LAW" on the right arm; and a blue adjustable baseball cap with Dredd's badge embroidered in gold-coloured thread on the front and a matching Adidas logo on the right. The set remains in good overall condition.

£1,500-£2,000

276. Stunt Lawgiver M

JUDGE DREDD (1995)

A stunt Lawgiver Mk. II pistol from Danny Cannon's sci-fi action film *Judge Dredd*. Judges used their Lawgivers to dispense their unique brand of justice on the mean streets of Mega-City One, each gun DNA-coded to ensure it would not fall into the wrong hands.

Used for scenes in which hero, live-firing Lawgivers were not required, the stunt Lawgiver is made of resin with a turned aluminium barrel. Vented detailing runs along its top and sides, with a secondary barrel below. The light panels running along the sides of the futuristic firearm have been finished in metallic red paint, with faux-silver paint on the magazine, grip and trigger housing. Displaying some minor scratches to the resin, the front features some damage and the weapon's foresight is no longer present. However, in spite of this wear, the Lawgiver remains in good overall condition.

Dimensions: 28 cm x 17 cm x 4.5 cm (11" x 8" x 2 3/4")

£2,000-3,000



277. Street Judge Helmet and Shoulder Armour M

JUDGE DREDD (1995)

A Street Judge helmet and shoulder armour from Danny Cannon's sci-fi action film *Judge Dredd*. Street Judges wore their armoured attire throughout the film as they attempted to uphold the law and dispense their unique brand of justice within Mega-City One.

Made of fibreglass, the helmet features a tinted visor, and is painted blue and red. The front is decorated with a metal badge and the interior is padded to provide comfort. The armour is constructed from black vacuum-formed plastic and features copper-coloured ridged detailing, a faux-gold "Johnson" Judge badge, multiple clip fastenings and foam applied to the inside for comfort during wear. A strip of tape is adhered to the armour, bearing the text "Nancy", and the helmet displays a label reading "Shawn", with other faded unreadable text. The lot displays minor paint wear from production use and the armour is missing a clip and a ridged shoulder section.

Dimensions (helmet): 27 cm x 19 cm x 23 cm (10 3/4" x 7 1/2" x 9 1/4"); (armour): 55 cm x 31 cm x 27 cm (21 3/4" x 21 1/4" x 10 3/4")

£3,000-5,000



278. Jumanji Game Board Ω

JUMANJI (1995)

A Jumanji game board from Joe Johnston's adventure film *Jumanji*. Static versions of the board were produced for various stunts, and for scenes where the characters carried the closed board game.

This game board is made from a combination of fibreglass, resin and wooden components. The main shell of the board is made of fibreglass and has small wooden legs attached to the bottom. The fibreglass is painted in detail with a wood-grain finish. On the front of the case is an ornate design, cast in resin and

painted to appear as though it is made from ivory. Overall, the piece is in fair condition and shows signs of wear, including portions of the bottom panel which are loose, scratches to the finish, and two missing wooden legs. Accompanying the lot is a certificate of authenticity from Columbia Pictures.

Dimensions: 40.5 cm x 30.5 cm x 9 cm (16" x 12" x 3 1/2")

£8,000-10,000



279. Park Brochure Ω

JURASSIC PARK (1993)

A visitor's brochure from Steven Spielberg's Oscar®-winning action adventure *Jurassic Park*. The park's brochures were used throughout the film at various locations, including the Visitor Center and the Ford Explorer tour vehicles.

This double-sided paper brochure features a printed map of Jurassic Park on one side. This pinpoints different sites on the island, including the Visitor Center, helipad, electric fencing and dinosaur enclosures. The reverse shows a printed drawing of the park gates, with general information including a section in Japanese, a Kodak Film advertisement and a mountain terrain photograph that forms the front cover of the brochure when folded. Displaying light evidence of use, the piece remains in good overall condition.

Dimensions (folded): 21 cm x 9.5 cm (8 1/4" x 4")

£1,000-1,500



280. Rain Jacket Ω

JURASSIC PARK (1993)

A yellow rain jacket from Steven Spielberg's Oscar®-winning action adventure *Jurassic Park*. Numerous staff members wore rain coats during the storm, including Dennis Nedry (Wayne Knight), Robert Muldoon (Bob Peck) and Dr. Ellie Sattler (Laura Dern).

The jacket is yellow in colour and is made from durable vinyl and nylon. The garment features the classic *Jurassic Park* logo, which is adhered to the left breast and also appears on the back. The jacket closes at the front with six plastic snap buttons, and includes two large front pockets with button closures. The rain jacket is marked as size XL and is missing its hood, but remains in very fine condition.

£1,500-2,500



281. Robert Muldoon's (Bob Peck) Hero Jeep Wrangler Licence Plate Ω

JURASSIC PARK (1993)

Robert Muldoon's (Bob Peck) hero Jeep Wrangler licence plate from Steven Spielberg's Oscar®-winning action-adventure *Jurassic Park*. After rescuing an injured Ian Malcom (Jeff Goldblum), park game warden Robert Muldoon drove his staff Jeep to out-run a Tyrannosaurus Rex. The mud splatter on the licence plate is screen matched to the final shot of the Jeep speeding off to safety after escaping from the T-Rex.

shows heavy mud splatter. The back of the plate shows 'Muldoon + Harding' written in marker, indicating that the plate was likely also used when the park visitors encountered Dr. Harding (Gerald R. Molen) near a sick Triceratops during the tour. The plate shows rusting to the aluminium due to age but remains in very fine condition.

Dimensions: 30.5 cm x 15 cm x 1 cm (12" x 6" x 1/4")

The licence plate is made of aluminium and features the *Jurassic Park* logo printed on the left, and the stamped vehicle number '10' on the right. The front of the plate

£3,000-5,000



282. Mike Sekowsky and Bernard Sachs Hand-Drawn Page 12 Chapter 3 Splash Artwork Ω

JUSTICE LEAGUE / BRAVE AND THE BOLD #30 (1960)

Hand-drawn page 12 Chapter 3 splash artwork by Mike Sekowsky and Bernard Sachs featuring Green Lantern and Aquaman as they travelled to Fernandina Island in *The Brave and the Bold* #30. The page features a 2/3 splash, and two smaller panels below. In this issue, the Justice League sought out animals with long lifespans in order to catch a criminal focused on creating an immortality elixir.

This original pencilled-and-inked artwork is drawn on Bristol board by penciller Mike Sekowsky and inker Bernard Sachs. The page shows Aquaman water skiing as he is pulled by The Green Lantern. The Green Lantern's ring was originally drawn on the incorrect finger, and was erased before being redrawn on the correct finger. The lower panels show the pair at the island where they plan to meet the old tortoise, "Old Ironhead," and Green Lantern using his power ring to create

a barrier around the island. At the top of the board is the chapter title art, which reads "CASE OF THE STOLEN-SUPER-POWERS".

Included with the lot is a reference copy of *The Brave and the Bold* #30, the comic book in which this art was originally published. Some white-out correction fluid is present, but the artwork remains in very fine condition. Dimensions: 36 cm x 54 cm (14 1/4" x 21 1/4")

Please note this lot is sold without copyright, reproduction rights, licencing agreements or any other type of legal release.

£18,000-22,000



283. John Romita Jr. Hand-Drawn Kick-Ass and Hit-Girl Magazine Cover Artwork Ω

KICK-ASS / SHORTLIST MAGAZINE #121 (2010)

Hand-drawn cover artwork by John Romita Jr. featuring Kick-Ass and Hit-Girl for issue #121 of the UK magazine *ShortList*. This cover artwork was seen on the issue immediately following the release of the 2010 film, with the artwork depicting Kick-Ass and Hit-Girl drawn in their traditional comic-art style, but with their costumes resembling the updated designs used in the film.

This original pencilled-and-inked artwork is drawn in nearly 1:1 scale on Bristol board by Kick-Ass comic penciller and co-creator John Romita Jr. and is one of the only original published Kick-Ass and Hit-Girl drawings by John Romita Jr. ever released on the market. Included with the lot is a reference copy of *ShortList* #121, the magazine in which this art was originally published. The magazine is signed on the front cover by John Romita Jr. Some minor stains and white-out correction fluid are present. The artwork is in very good condition.

Dimensions: 26 cm x 28 cm (10 1/4" x 11")

Please note this lot is sold without copyright, reproduction rights, licencing agreements or any other type of legal release.

£800-1,200



284. Guinevere's (Keira Knightley) Final Battle Costume M

KING ARTHUR (2004)

Guinevere's (Keira Knightley) final battle costume from Antoine Fuqua's historical action film *King Arthur*. The Celtic warrior wore her costume as she led the Woad archers into the final battle against the Saxons.

The costume consists of a crop top, various belts, brown linen trousers, a pair of leather greaves and brown boots. The top comprises brown leather cord woven into sections, with a nude Lycra band underneath (featuring remnants of blue battle make-up to match Guinevere's skin) and lacing detailing with metal-stud decoration at the back. Patches of brown leather and suede, varying in length, hang from the waist, with a dark brown woven belt attached over the top.

The trousers are labelled "Guinevere" and multiple pieces within the costume display decorative stitching and intentional distressing, producing a worn, handmade appearance. The costume is presented on a custom-made mannequin.

Dimensions (displayed): 27 cm x 41 cm x 155 cm (10 3/4" x 16 1/4" x 61")

£2,000-3,000



285. King Arthur's (Clive Owen) Suit of Armour M

KING ARTHUR (2004)

King Arthur's (Clive Owen) suit of armour from Antoine Fuqua's historical action film *King Arthur*. The Roman cavalry officer wore his armour during the final battle scenes, as he led his men in a vicious fight against the Saxons.

Consisting of multiple components created by armourer Terry English, the suit comprises a metal helmet (labelled "King Arthur, Terry English") finished in silver-coloured paint; chest plates, greaves (labelled "1st Arthur battle") and a pair of bracers (labelled "*King Arthur*, Clive Owen, 1"); and an under layer, which consists of a canvas tunic with incorporated leather banding and chain-mail sections, leather trousers with decorative metal studs, and a pair of black lace-up boots.

Raised faux-gold detailing adorns each section of armour, notably on the front chest plate, where lion head and eagle emblems are incorporated into the design. Leather pteruges with faux-gold metal medallions and emblems hang from the chest armour, and layered shoulder pauldrons are adhered to the top. Straps and buckles fix the plates together at the sides. A red ombré plume decorates the top of the helmet, with longer strands of purple hair at the back. The sides of the helmet display movable flaps, with brown cord attached to secure the helmet. Pieces of foam are attached on the helmet's interior.

The battle-worn suit of armour shows signs of wear from production use, including minor marks, scratches and a hole in the back of the tunic. The costume is presented on a custom-made mannequin display.

Dimensions: 36 cm x 78 cm x 215 cm (14 ¼" x 30 ¾" x 84 ¾")

As this item is oversized it will require a specialist shipping service with additional costs. Please contact us prior to purchasing to request a quote.

£6,000-8,000

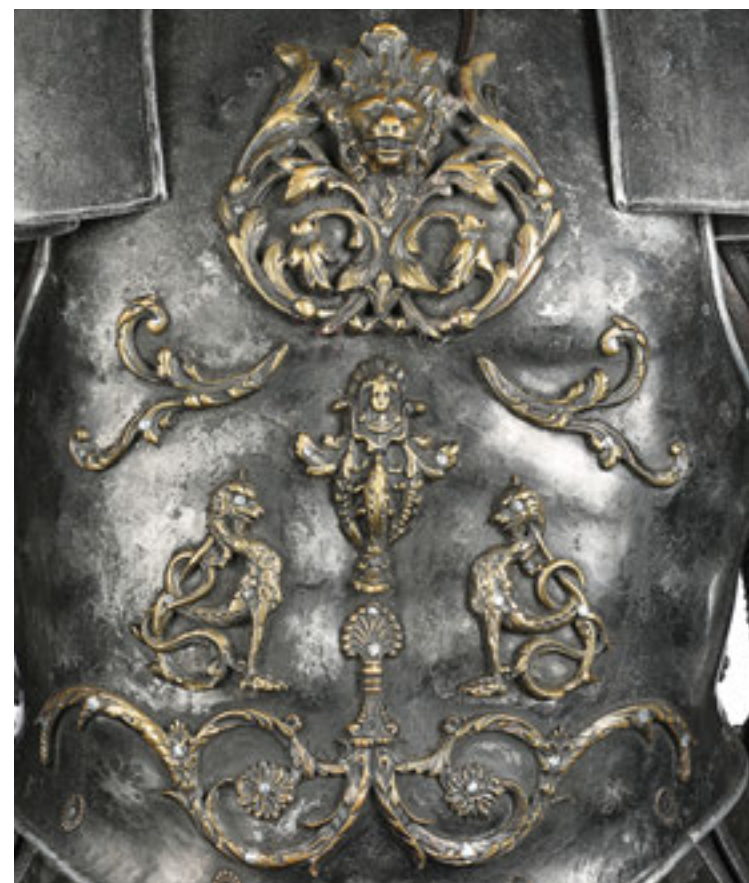

286. Dave Gibbons Hand-Drawn Page 18 Artwork and Graphic Novel Back Cover Art Ω

KINGSMAN: THE SECRET SERVICE #4 (2012)

Hand-drawn page 18 artwork by Dave Gibbons featuring Eggsy donning his new suit for *The Secret Service #4*. A defining moment for any new Kingsman, this page shows Eggsy admiring his new look as an agent for the Kingsmen. This main image was also used as the back cover of the *Kingsman: The Secret Service* graphic novel, which reprinted the entire series in one book. This scene also served as inspiration for a similar moment in the first *Kingsman* movie.

This original pencilled-and-inked artwork is drawn on Bristol board by artist Dave Gibbons (*Watchmen*). The artwork features three panels, each showing Eggsy inside the Kingsman tailor shop in London. At the bottom and top right corner are handwritten notes, including "SS#4" and "18". No speech balloons are present as they were created digitally. Included with the lot is a reference copy of *Secret Service #4*, the comic book in which this art was originally published. The artwork is in very good condition. Dimensions: 43 cm x 30 cm (17" x 11 ¾")

Please note this lot is sold without copyright, reproduction rights, licencing agreements or any other type of legal release.

£500-700



287. Kubo, Monkey and Beetle Stop-Motion Puppet Faces Gift Ω

KUBO AND THE TWO STRINGS (2016)

Kubo, Monkey and Beetle stop-motion puppet faces from Travis Knight's fantasy-adventure film *Kubo and the Two Strings*. Gifted to reviewers and critics during the film's theatrical release, this lot consists of three puppet faces from the production that were created by renowned stop-motion animation studio, Laika. The faces include Kubo (voiced by Art Parkinson), Monkey (voiced by Charlize Theron), and Beetle (voiced by Matthew McConaughey).

Each face is made of 3D-printed resin and would have attached to the head via magnets, allowing puppeteers to quickly switch out the characters' expressions. The lot remains in very fine condition, and is accompanied by an official Laika certificate of authenticity. Dimensions: 30.5 cm x 10 cm x 13 cm (12" x 4" x 5")

£1,000-1,500



288. Brian Froud Concept Art M**LABYRINTH (1986)**

Poster concept art for Jim Henson's fantasy adventure *Labyrinth*. Brian Froud, long-time collaborator to Jim Henson, worked as the film's conceptual designer, imagining many of the beloved fantastical creature puppets. Henson and Froud collaborated on similar styled productions, including *The Dark Crystal* and TV's *The Storyteller*.

Hand-drawn in graphite pencil, the art shows the Goblin King, Jareth (David Bowie) surrounded by several main characters, including Hoggle and Ludo, with Sarah (Jennifer Connelly) running in the foreground. Accompanying the art is a letter of authenticity from Froud himself, as well as a copy of a letter from Lucasfilm Ltd detailing the edits required of the artist to create the final sketch. As a result of age and storage, the art shows some staining across the right sides and corners, with minor tears and creases on the edges.

Dimensions: 42 cm x 30 cm (16 ½" x 12")

£2,000-3,000

**289. Goblin Puppet Head Ω****LABYRINTH (1986)**

A Goblin head from Jim Henson's fantasy film *Labyrinth*. After wishing for goblins to take her baby brother away, Sarah (Jennifer Connelly) journeyed through a labyrinth to save him from Jareth, the Goblin King (David Bowie).

Made of foam latex, the head has eyebrows made of faux hair and eyes cast from resin. The eyes also feature red reflective pupils, making them appear illuminated. A patch of Velcro is attached to the back of the head, so any hat or helmet appliances could be attached during production. A nylon sleeve runs below the head for hand access, with cotton netting running below to disguise it. The head rests on a wooden display and shows wear to the foam, which has become brittle with age. The piece remains in delicate but good overall condition. Dimensions: 23 cm x 16.5 cm x 35.5 cm (9" x 6 ½" x 14")

£2,000-3,000

**290. Lara Croft's (Angelina Jolie) Pair of Hero Pistols, Belt and Holster Rig M****LARA CROFT: TOMB RAIDER (2001)**

Lara Croft's (Angelina Jolie) hero pistols and belt rig from Simon West's video-game adaptation *Lara Croft: Tomb Raider*. Synonymous with her character, Croft used her iconic weapons throughout the film, from the opening sequence in which Croft battles S.I.M.O.N., a sophisticated training robot, to her adventures in Cambodia and Siberia as she fought for possession of the legendary Triangle of Light.

Under the supervision of stunt co-ordinator Simon Crane, Jolie went through an extensive physical and weapons training regimen to allow her to perform many of Croft's stunt sequences herself. Croft's character is ambidextrous, so Jolie was required to use pistols in both hands at the same time. For ease of use, her left pistol was modified with a custom slide-release switch for quick magazine changes.

The two hero firearms are 9mm Heckler & Koch USP Match pistols that feature black frames and stainless steel slides. They have been sympathetically deactivated with the slide, hammer, safeties, slide releases and magazine releases still functional. Deactivation certificates are included.

Accompanying the pistols is a rig comprising a pair of black leather holsters and a matching belt. The belt features a 'Death's Head' buckle that is cast in resin and finished in faux-gold paint. The holsters have custom-designed clips to hold the guns in place, as well as adjustable straps for securing them firmly to the actor's thighs.

Well-worn, the pistols and rig show evidence of age and production use, including wear on the pistols and buckle, corrosion around the brass fittings on the belt and worn leather throughout.

Dimensions (per pistol): 24 cm x 4 cm x 15 cm (9 ½" x 1 ½" x 6")

This weapon has been permanently and sympathetically deactivated to UK legal requirements (at the time of deactivation) and no longer retains any functional capacity to fire. It is accompanied by a proof house certificate of deactivation. The weapon may require further deactivation and re-certification prior to shipping at the buyers expense, based upon current legislation, buyer and weapon location. It is solely the buyer's responsibility to check, prior to bidding, the legal status of this weapon within their own country and the importation thereof.

£15,000-20,000



291. Temple Guardian Sword †Δ

LARA CROFT: TOMB RAIDER (2001)

A Temple Guardian sword from Simon West's video game adaptation *Lara Croft: Tomb Raider*. The reanimated Temple Guardians attacked Lara Croft (Angelina Jolie) with their giant swords as she faced off against Manfred Powell (Iain Glen) during the Cambodian Temple battle.

Featuring an ornately detailed hilt, the sword is made of resin and filled with expanding foam to keep it lightweight for production use. The paintwork is

intended to mimic bronze and steel, with additional intentional wear to create the look of an ancient artefact.

Aside from production-created distressing, the sword displays minor wear from use and time in storage. Dimensions: 104 cm x 18 cm x 6 cm (41" x 7" x 2 ¼")

£600-800



292. Cradle of Life Medallion †Δ

LARA CROFT TOMB RAIDER: THE CRADLE OF LIFE (2003)

The Cradle of Life medallion from Jan de Bont's action-adventure sequel *Lara Croft Tomb Raider: The Cradle of Life*. Lara (Angelina Jolie) first took the medallion from the underwater Santorini temple. It was worn by Chen Lo (Simon Yam) during the temple fight, and by Lara as she fought Jonathan Reiss (Ciarán Hinds).

The copper medallion is approximately 3 mm thick, with subtle detail and four necklace eyelets on its circumference. One eyelet is dented. A female piper figure is embossed on both sides, surrounded by undulating lines representing sound waves. Hanging from two knotted brown leather thongs, the medallion has been distressed for production and shows some discolouration from age.

Dimensions (medallion): 7 cm x 7 cm x 0.5 cm (2 ¾" x 2 ¾" x ¼"); (including thong): 48 cm x 7 cm x 2 cm (19" x 2 ¾" x ¾")

£800-1,200

293. Lara Croft's (Angelina Jolie) SFX Underwater P11 Gun M

LARA CROFT TOMB RAIDER: THE CRADLE OF LIFE (2003)

Lara Croft's (Angelina Jolie) SFX underwater P11 gun from Jan de Bont's action-adventure sequel *Lara Croft Tomb Raider: The Cradle of Life*. Croft wielded her weapon during the opening sequence of the film as she narrowly escaped Chen Lo's (Simon Yam) attack at the Luna Temple.

Based on the Heckler & Koch P11, the gun is made from black plastic and features five barrels coloured matt grey to resemble metal. It has a functional trigger and a sliding imitation safety switch. Extending from the grip is multicoloured cabling, covered in black fabric, that controls LED lights and allows air bubbles to shoot from the end of the gun for the underwater special-effects shots. The weapon shows minor wear from use on the production, including slight surface marks and corrosion around the metal screw heads from being in water.

Dimensions (gun): 17 cm x 19 cm x 6.5 cm (6 ¾" x 7 ½" x 2 ¾")

This item contains electronic components. While every effort has been made to describe them accurately, no guarantee or warranty is made as to functionality, lifespan or safety of those components. It is entirely incumbent on the new owner to satisfy themselves as to their safe use and maintenance.

£1,500-2,500



294. Luna Temple Orb and Holder †Δ

LARA CROFT TOMB RAIDER: THE CRADLE OF LIFE (2003)

The Luna Temple Orb from Jan de Bont's action-adventure sequel *Lara Croft Tomb Raider: The Cradle of Life*. The Orb was acquired from an ancient Greek temple and appeared throughout, including the Chinese lab shoot-out, the scene in which it was held by Terry Sheridan (Gerard Butler) on the ship, and the Chinese apartment scene where Lara Croft (Angelina Jolie) showed it to Bryce (Noah Taylor) via webcam. Lara also used the Orb during the African crater scenes in which she hit Reiss' (Ciarán Hinds) henchman with it before dropping it into the Keyhole.

The solid resin sphere is an amber colour; lines and circular marks throughout its outer and inner surfaces represent the ancient code used to activate its powers. Inside, reflective, textured materials create a mysterious appearance. The metal holder has been distressed to resemble aged, pitted copper. Sharp, narrow spikes protrude inward from the arms and apex of the holder, with ancient Grecian detail adorning the base of each. An open base and screw holes allow for fixing to a support. The Orb features some wear and scratching from production use, while the Orb Holder shows production-based marking and wear, with minor discolouration from age.

Dimensions (holder): 28 cm x 28 cm x 29 cm (11" x 11" x 11 ½"); (Orb): 16 cm x 16 cm x 16 cm (6 ¼" x 6 ¼" x 6 ¼"); (with Orb in holder): 28 cm x 28 cm x 29 cm (11" x 11" x 11 ½")

£3,000-5,000



295. Lara Croft's (Angelina Jolie) Earpiece †Δ

LARA CROFT TOMB RAIDER: THE CRADLE OF LIFE (2003)

Lara Croft's (Angelina Jolie) earpiece from Jan de Bont's action-adventure sequel *Lara Croft Tomb Raider: The Cradle of Life*. Capable of visual recording, the special earpiece gadget was worn by Croft throughout the film, notably at the beginning when she discovered the Luna Temple, and in the lab when she stole the orb from Jonathan Reiss (Ciarán Hinds).

The frame of the earpiece is constructed from dark grey plastic and rubber and is designed to fit comfortably over the ear. It features a clear acrylic eye piece mounted to a small black camera detail with a metal camera lens. Accompanying the earpiece is a custom-made black plastic case. There is evidence of production wear, including surface scratches and glue residue around the eyepiece.

Dimensions: 15 cm x 9 cm x 2.5 cm (6" x 3 ½" x 1")

£2,000 - 3,000



296. Lara Croft's (Angelina Jolie) H&K USP Pistols †Δ

LARA CROFT TOMB RAIDER: THE CRADLE OF LIFE (2003)

A twin pair of Lara Croft's (Angelina Jolie) H&K USP pistols from the 2003 Jan de Bont action-adventure sequel *Lara Croft Tomb Raider: The Cradle of Life*. Lara used her H&K USP Match pistols in several scenes, most notably in the Chinese village, ruin capture and the temple shoot-out.

Made of black plastic and finished in faux-gold paint, the guns are based on UHC Airsoft pistols and would have been used as stand-ins when live-fire hero pistols were not needed for a shot. One pistol features a custom extended

slide release detail above the trigger for use in Lara's left hand, and the H&K logo can be seen on several parts of the weapons. Lara Croft's pistols show signs of wear from use in production, including scrapes, small chips and marks.

Dimensions (per pistol): 23.5 cm x 15 cm x 4.5 cm (9 ¼" x 6" x 2")

£2,000-3,000

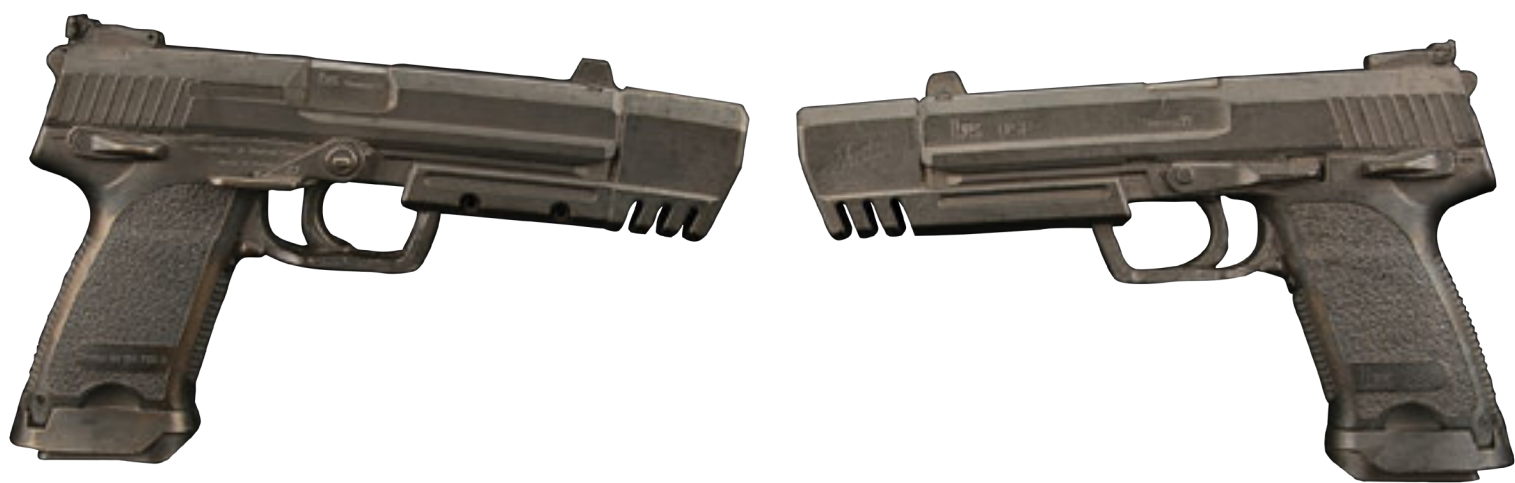

297. Katsumoto's (Ken Watanabe) Katana Ω

THE LAST SAMURAI (2003)

Katsumoto's (Ken Watanabe) katana from Edward Zwick's historical war epic *The Last Samurai*. Katsumoto used his katana throughout the film as he fought the Japanese Imperial Army — first against, then alongside, American soldier Nathan Algren (Tom Cruise). This sword screen-matches to the scene where Katsumoto speaks with Algren by a campfire, the night before the climactic battle.

Made by Weta Workshop, the sword is constructed entirely of resin. The grip is crafted to resemble wood with an ornate guard, and the handle is made to

appear bound in cloth. The blade is dulled for safety during combat and features engraved symbols cast on its right side. The prop sword shows spots of dried faux blood from use during fight scenes, and exhibits some wear from production use, including chips in the paint finish.

Dimensions: 99 cm x 8 cm x 6 cm (39" x 3" x 2 ½")

£2,000-3,000



298. Light-Up EVA Helmet †Δ

LIFE (2017)

An EVA helmet from Daniel Espinosa's horror sci-fi *Life*. An extravehicular activity helmet was worn by Rory Adams (Ryan Reynolds) at the beginning of the film when capturing the Martian probe; another was later worn by Ekaterina Golovkina (Olga Dykhovichnaya) when she attempted to repair the overheating communications systems.

The helmet consists of an ABS plastic frame covered in a white canvas-like material. It features a spherical clear-plastic visor with a faux-gold sun visor and adjustment dials on either side. Mounted on a custom-made display, the helmet has three metal fixtures housing lights across the top. A switch on the display base illuminates the lights, powered by three AA batteries. The headpiece shows minor wear from production use, including surface scratches on the visors and small stains on the white fabric.

Dimensions (displayed): 42 cm x 43 cm x 54 cm (16 ½" x 17" x 21 ¼")

This display contains electronic components. While every effort is made to describe them accurately, no guarantee or warranty is made as to functionality, lifespan or safety of those components. It is entirely incumbent on the new owner to satisfy themselves as to their safe use and maintenance.

£2,000-3,000



299. Miranda North's (Rebecca Ferguson) IVA Suit †Δ

LIFE (2017)

Miranda North's (Rebecca Ferguson) IVA suit from Daniel Espinosa's sci-fi horror *Life*. Miranda wore her suit towards the end of the film as she and David (Jake Gyllenhaal) entered the two remaining escape pods, with her pod being damaged by flying debris and sent hurtling away from Earth.

The costume consists of a helmet, a brown leather skullcap with beige paneling, a beige cotton utility jumpsuit, a pair of beige boots and a backpack. The helmet features metal banding, strips of boning at the back with visible stitching, a transparent plastic visor and a black throat microphone positioned near the skullcap's chinstrap.

Two zips run down the front of the suit, allowing a section to come away. Embroidered, Velcro-adhered mission patches are present throughout. Various components are adhered to the front, including multiple buckled straps, blue strips on the arms and a plastic gauge on the left sleeve. A grey utility strap runs across the chest with a name strip featuring the character's name embroidered in blue English and Russian text. The shaped backpack features mesh panels, two straps and a zip.

Original costume labels are located inside the garments, including a strip of cotton tape in the skullcap reading "North" and labels reading "Production – Life; Character – North; Name – Rebecca". The costume is presented on a custom-made mannequin display with the base featuring the film's title. Dimensions (displayed): 40 cm x 49 cm x 180 cm (15 ¾" x 19 ¼" x 71")

£5,000-7,000



300. Production-Used Clapperboard M**LITTLE SHOP OF HORRORS (1986)**

A production-used clapperboard from Frank Oz's comedy-musical *Little Shop of Horrors*. Made of black-painted wood, the clapperboard displays the film's title painted in white at the top, and the names of director Frank Oz and director of photography Robert Paynter below. Lines of white paint divide the clapperboard into two sections, where the slate and take numbers would have been written in chalk. A green piece of cord has been tied to two metal rings attached to the back.

The board shows signs of age and use, including corrosion on the metal hinge on the clapper stick and wear to the paint, most notably in the box labelled "Cam". Minor scratches and chips in the wood are also present.

Dimensions: 1.5 cm x 26 cm x 20.5 cm (3/4" x 10 1/4" x 8")

£2,000-3,000

**301. Frodo's (Elijah Wood) Hobbit Ears †****THE LORD OF THE RINGS (2001 - 2003)**

A pair of Frodo's (Elijah Wood) hobbit ears from Peter Jackson's adaptation of J.R.R. Tolkien's fantasy epic *The Lord of the Rings*. Hobbits of the Shire, or halflings, were recognisable by their short stature, oversized feet and pointed ears. Four hobbits — Frodo, Samwise (Sean Astin), Merry (Dominic Monaghan) and Pippin (Billy Boyd) — joined the Fellowship on the quest to destroy the One Ring.

Each actor's ears were custom-made to ensure a secure fit. The pointed appendages are created using latex, with a gap for the actor's ear canal to allow them to hear on set. They are hand-painted in various flesh tones to resemble skin. The edges have become slightly brittle with age, but remain in otherwise good condition.

Dimensions (each): 7 cm x 3 cm x 4 cm (2 3/4" x 1 1/4" x 1 1/2")

£3,000-5,000



Moviestore Collection/REX/Shutterstock

302. Legolas' (Orlando Bloom) Prosthetic Elf Ear Tips †Δ**THE LORD OF THE RINGS (2001 - 2003)**

Legolas' (Orlando Bloom) elf ear tips from Peter Jackson's adaptation of J.R.R. Tolkien's fantasy epic *The Lord of the Rings*. Bloom wore his elf ear tips throughout his performance as Legolas, from his first appearance at the Council of Elrond to the trilogy's moving conclusion.

These prosthetic ear tips were an essential part of Legolas' elven appearance and costume. They are a pair of several created by Weta Workshop for Bloom during the epic production, which required multiple versions of each costume and make up appliances for the performers.

Their flesh-like colour and shape has been designed to suit the actor's complexion and makeup, completing the lifelike appearance director Peter Jackson needed for each character. Each ear tip has paper and material stuck to one side, from where they were applied to the actor's ears and costume. They are significantly worn from use during production and, while they have lost some of their original points, the ear-like styling is clearly visible. The item includes a letter of authenticity from the actor's mother Sonia Bloom.

Dimensions: 24 cm x 10 cm x 0.01 cm (9 1/2" x 4" x 1/2")

£3,000-5,000

**304. Collection of Costume Swatches M****THE LORD OF THE RINGS (2001 - 2003)**

A set of three wardrobe swatch boards from Peter Jackson's adaptation of J.R.R. Tolkien's fantasy epic *The Lord of the Rings*. Swatch boards are used to demonstrate the aesthetic of costumes before work commences on creating the finished outfits.

Each frame contains approximately 20 different swatches from characters including Legolas (Orlando Bloom), Elrond (Hugo Weaving), Arwen (Liv Tyler), Gimli (John Rhys-Davies) and Pippin (Billy Boyd). They are fixed via wire and glue to a red felt-covered board, which is framed with unglazed, cream-coloured wood. On the reverse is a list and map of the components, with signed authentication by Warren Green, a credited Weta Workshop armour smith.

Dimensions (each frame): 46 cm x 41 cm x 3 cm (18" x 16" x 1 1/4").

£1,000-1,500

**303. Crew-Made Metal Uruk-hai Swordsman Helmet M****THE LORD OF THE RINGS (2001 - 2003)**

A crew-made Uruk-hai helmet from Peter Jackson's adaptation of J.R.R. Tolkien's fantasy epic *The Lord of the Rings*. The Uruk-hai who served Saruman (Christopher Lee) wore their distinctive helmets throughout the film trilogy, with this style worn by the swordsmen.

Crafted by an armourer working on the films, the helmet is constructed from welded and riveted black metal. It follows the same rough, crude pattern as those featured in the movies, incorporating a narrow eye-slit, pointed cheek blades and a fan-shaped crest. A leather strap and metal buckle form the chin strap.

Dimensions: 43 cm x 36 cm x 29 cm (17" x 14 1/4" x 11 1/2")

£1,000-1,500



305. Legolas' (Orlando Bloom) Lothlórien Arrow †

THE LORD OF THE RINGS (2001 - 2003)

Legolas' (Orlando Bloom) Lothlórien arrow from Peter Jackson's adaptation of J.R.R. Tolkien's fantasy epic *The Lord of the Rings*. The Elven prince from the forest of Mirkwood was gifted a special bow and quiver of arrows by the Lady Galadriel (Cate Blanchett) upon the Fellowship's departure from Lothlórien, which was used throughout the rest of his adventure across Middle-earth.

The arrow has a wooden shaft, fletched with three tapered yellow feathers and bronze-coloured thread, and is tipped with a long, narrow metal head finished with faux-gold, engraved with a long swirl motif. The shaft appears green on screen, but the paint has faded with age.

This item was released by production to Sideshow Collectibles, a New Line Cinema licensee, as a reference piece for creating the company's line of replicas and figures. The shaft is engraved with the prop's details, the recipient and a reference code, the latter of which is also repeated on the arrowhead. Also included is a 12" x 8" colour photo of the actor in character. The arrow shows minor wear, but remains in very good condition.

Dimensions: 97 cm x 4 cm x 5 cm (38 1/4" x 1 1/2" x 2")

£8,000-10,000



Moviestore Collection/REX/Shutterstock

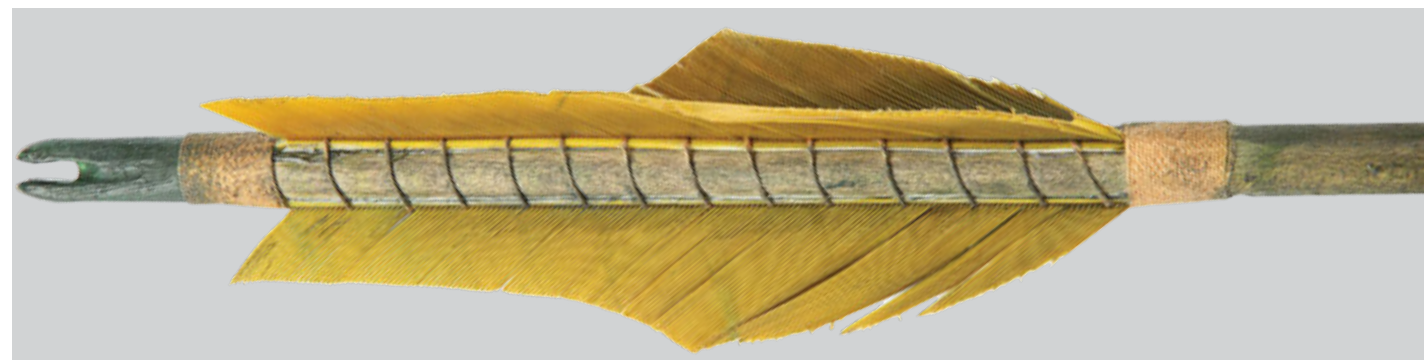

306. Uruk-hai Final Make-Up Test Bust †

THE LORD OF THE RINGS (2001 - 2003)

An Uruk-hai make-up test bust from Peter Jackson's adaptation of J.R.R. Tolkien's fantasy epic *The Lord of the Rings*. The Uruk-hai, an evil race of Orcish creatures, served both Saruman (Christopher Lee) and the Dark Lord Sauron throughout the trilogy of films. Make-up tests were created as part of the design and approval process for the creature's look.

The bust has a foam core covered in a latex skin, much like the one that was to be worn by the performers on set. The wrinkled flesh is painted shades of red, black and orange with the "white hand of Saruman" in white across the forehead and cheeks. Completing the appearance of the piece is a patch of long, black synthetic hair tied with a thong into a ponytail and sprayed with a tacky substance to make it look unkempt. There are some air bubbles present from the casting process and it remains in very good condition.

Dimensions: 29 cm x 28 cm x 41 cm (11 1/2" x 11" x 16")

£4,000-6,000



307. Prosthetic Orc Mask and Teeth M

THE LORD OF THE RINGS (2001 - 2003)

An Orc mask and teeth from Peter Jackson's adaptation of J.R.R. Tolkien's fantasy epic *The Lord of the Rings*. Prosthetics were used to bring this evil race of creatures to life throughout the trilogy of films.

The mask was created by the artists at Weta Workshop in New Zealand, who under the direction of Richard Taylor and Peter King won an Oscar® for Best Make-up on *Return of the King*. The mask is constructed from latex and is painted with mottled shades of brown, with holes cut out for the eyes, nostrils and mouth, and smaller holes in the ears. A small amount of artificial hair is still present. A set of pointed acrylic teeth complete the set.

Presented on a black flocked head for support, the edges of the mask have begun to dry with age, and some light restoration has been carried out around the hairline and the back of the neck. Dimensions (displayed): 23 cm x 24 cm x 22 cm (9" x 9 1/2" x 8 3/4")

£3,000-5,000



308. Herugrim — Sword of Théoden (Bernard Hill) Ω

THE LORD OF THE RINGS: THE RETURN OF THE KING (2003)

Herugrim, the sword of Théoden (Bernard Hill), from Peter Jackson's adaptation of J.R.R. Tolkien's fantasy epic *The Lord of the Rings: The Return of the King*. Théoden was the 17th King of Rohan and was under a spell that took his strength and power. Once the spell was broken by Gandalf The White (Ian McKellen), Théoden wielded Herugrim to fight Sauron's forces at the Battle of Pelennor Fields, where he was ultimately defeated by the Witch-king of Angmar.

This sword was specially made for the character of Théoden by New Zealand's Weta Workshop. It was awarded as a prize during a prize draw sponsored by Parker Brothers and New Line Cinema, in which owners of Lord of the Rings-themed tabletop games were given the opportunity to win one of eight weapons, each belonging to a different character. This competition was specifically held to promote the finale of the epic fantasy saga.

Herugrim is crafted with an aluminium blade that shows intentional distressing along the edges. The ornate urethane hilt features two horse heads meeting at the nose, forming a heart. As the sword was given away as a promotional prize by the studio, it is presented in a custom acrylic case with a plaque featuring the film's title, release date and the New Line Cinema logo.

Accompanying the lot is a certificate of authenticity signed by producer Barrie Osborne. The piece shows minimal signs of wear and is in very fine overall condition.

Dimensions (in display): 102 cm x 10 cm x 19 cm (40" x 4" x 7 ½")

£40,000 - 60,000



309. Merry's (Dominic Monaghan) Feet Appliances Ω

THE LORD OF THE RINGS (2001 - 2003)

Merry's (Dominic Monaghan) feet appliances from Peter Jackson's adaptation of J.R.R. Tolkien's fantasy epic *The Lord of the Rings: The Fellowship of the Ring*. Large and hairy feet were a defining characteristic of the Hobbits of Middle-earth.

Made by Weta Workshop, these feet are produced from foam latex in order to ensure a tight fit that resembles actual bare skin. Each foot is painted in detail, with light flesh tones, and the toes feature long, wiry hand-punched hairs. Both feet are labeled internally in marker for the character of Merry. Additionally, the feet are dirtied on the bottom from being worn for filming.



A custom-made acrylic display case is included with this lot. The feet show signs of wear from use, including cracking to the toes and splits to the foam latex near the ankles. The large splits have been sympathetically repaired and stabilised, leaving the lot in fine overall condition.

Dimensions (each foot): 29 cm x 11.5 cm x 9 cm (11 1/2" x 4 1/2" x 3 1/2"); (display): 35 cm x 35 cm x 20.5 cm (14" x 14" x 8")

£5,000-7,000



310. Opening Sequence Transporter Model Miniature M

LOST IN SPACE (1998)

A model miniature Transporter from the opening scenes of Stephen Hopkins' sci-fi film *Lost in Space*. A Transporter approached the Hypergate construction site during the film's opening scenes, before it was attacked by Global Sedition raiders. This model was created for special-effects use in the sequence.

Fabricated from fiberglass, this highly detailed spaceship displays a raised geometric pattern across the hull, producing a layered appearance, and has been finished in red. Additional small, tile-like panels, which feature decorative cast-in symbols, cover the main body of the ship, which is finished in a variety of colours. Featuring a motion-control mounting point, the transporter contains

internal electronics which remain untested. The lot shows paint wear and glue residue from production use, notably on the right wing. Care should be taken when handling the model as it remains in a fragile state. The model is accompanied by a box of repair parts. Dimensions: 155 cm x 135 cm x 46 cm (61" x 53 1/4" x 18 1/4")

This item contains electronic components. While every effort has been made to describe them accurately, no guarantee or warranty is made as to the functionality, lifespan or safety of those components. It is entirely incumbent on the new owner to satisfy themselves as to their safe use and maintenance.

£3,000-5,000



311. Major Don West's (Matt LeBlanc) Hero Spacesuit †

LOST IN SPACE (1998)

Major Don West's (Matt LeBlanc) hero spacesuit from Stephen Hopkins' sci-fi film *Lost in Space*. The fighter pilot wore his spacesuit as the crew began their journey onboard the Jupiter 2. This version of the suit features additional pieces seen when Don entered suspended animation.

Multiple versions of the suits were created for each character, with lifecasts taken from each actor in order for moulds to be produced for each suit. Costume designer Vin Burnham carefully created the cryo suits to feature no form of fastening, which meant the actors had to be sealed into them for each day of filming with medical glue.

The underlayer of the costume consists of a wetsuit made from black material, with rubber panels secured to the exterior, finished in varying shades of grey. Panel line detailing is present to add to the dynamic appearance of the suit. A resin badge reading "Jupiter Mission" decorates the right breast. Asymmetrical vac-formed pieces finished in light grey and faux gold are adhered to the left side of the chest, shoulders, waist, wrists and upper thighs. The suit is completed by a pair of black thick soled boots and a matching visor.

Cast-in detailing and a combination of small red and green LEDs are incorporated into the plastic pieces, powered by a 6-volt plug located in a compartment on the left side of the suit's custom-made mannequin display. The display has a chromed tread-plate base. The rubber elements of the costume show minor wear. Dimensions (suit display): 34 cm x 65 cm x 167 cm (13 1/2" x 25 1/4" x 63")

As this item contains electronic components, every effort has been made to describe them accurately. However, no guarantee or warranty is made as to the functionality, lifespan or safety of those components. It is entirely incumbent on the new owner to satisfy themselves as to their safe use and maintenance.

As this item is oversized it will require a specialist shipping service with additional costs. Please contact us prior to purchasing to request a quote.

£6,000-8,000



312. Immortan Joe's (Hugh Keays-Byrne) War Club Ω

MAD MAX: FURY ROAD (2015)

Immortan Joe's (Hugh Keays-Byrne) war club from George Miller's action classic *Mad Max: Fury Road*. The lord of the Citadel carried his war club as he chased a group of escapees led by his top warrior Imperator Furiosa (Charlize Theron) joined later by Mad Max (Tom Hardy). Joe notably held it when he realised the fugitive group were heading back to the unguarded Citadel before the film's climatic scenes.

Sourced directly from Hugh Keays-Byrne, this antique oiled wood club is studded with a variety of emblems made from metal and plastic, which are attached to the club with brightly coloured adhesive.

The War Club is adorned with symbols of violent victories including a tiger's eye from India, a New York Subway token, various plastic gemstones and multiple army-themed emblems. Symbolising Immortan Joe's power, the various mementoes were personal to Keays-Byrne, who attached them to the club while preparing for the role during the months leading up to filming in Namibia. The club displays signs of production use, including minor scratches and wear to both ends, while signs of corrosion are present on some of the metal emblems. The head of the piece displays adhesive remnants from damaged emblems. Dimensions: 122 cm x 11 cm x 11 cm (48" x 4 1/2" x 4 1/2")

£10,000-15,000

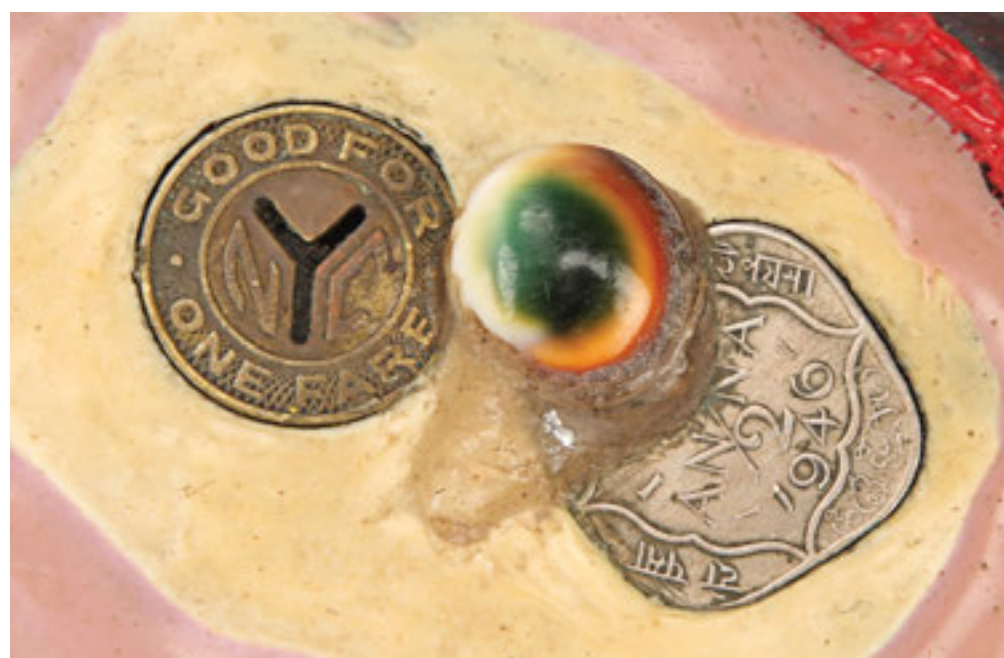

313. Josh Faraday's (Chris Pratt) Costume Ω

THE MAGNIFICENT SEVEN (2016)

Josh Faraday's (Chris Pratt) costume from the final showdown in Antoine Fuqua's Western remake *The Magnificent Seven*. Faraday wore his gunslinger outfit when he partnered with six other gunmen to defend Rose Creek against a ruthless robber baron.

Faraday's costume includes a bullet-ridden vest, a long-sleeve thermal shirt, a pair of bullet-ridden trousers, a leather belt, a bandana and a back-up hat. The brown vest features a jacquard-woven front with a cotton back, and shows five bullet holes from Faraday's final stand. Inside the vest are incisions where squibs were previously rigged. The thermal shirt is made of cotton and shows a bullet hole on the right arm, with remnants of stage blood and dirt throughout. Written on a manufacturer label inside is "FARADAY L". The brown jeans also show two holes, one on each thigh. Faraday's belt is made of studded leather with a metal buckle. His hat is made of felt, by Baron Hats.

Accompanying this lot are two certificates of authenticity from Metro Goldwyn Mayer. The costume exhibits intentional production distressing, but remains in very fine condition.

£2,000-3,000



314. The Mask's (Jim Carrey) Neck Tie M

THE MASK (1994)

The Mask's (Jim Carrey) neck tie from Charles Russell's action comedy *The Mask*. The eccentric superhero wore his neck tie when he interrupted a bank robbery, before using the money to gain entry to Coco Bongo, where he danced energetically with Tina (Cameron Diaz). The tie was partly damaged when Dorian Tyrell (Peter Greene) pulled out a gun and shot at The Mask.

The tie is made from silk and displays angled black-and-white printed pattern segments. Each section features a subtle floral pattern with polka dots, varying in size and style. Minor damage is present on the lining at the bottom, and the tie shows a small yellow mark from production use.

£600-800





315. Skeletor's Light-Up Barge Model Miniature M

MASTERS OF THE UNIVERSE (1987)

Skeletor's light-up barge model miniature from Gary Goddard's fantasy adventure *Masters of the Universe*. He-Man (Dolph Lundgren) and his companions fled to earth with the Cosmic Key, a powerful device capable of opening portals throughout the galaxy — a prize greatly desired by Lord Skeletor (Frank Langella). When Skeletor's army failed to retrieve the Key, he journeyed to earth himself on his throne barge. Full-size and miniature versions were created to accommodate different shots required for the production.

The barge is built around a metal chassis and covered in a combination of biscuit foam, resin and plastic components, with assorted greeblies beneath the throne platform and skull details on the barge panels. The entire surface is painted in dark shades of brown and grey and given a lightly distressed appearance. A small resin figure of Skeletor is seated upon a throne with serpent-shaped arms, holding the Cosmic Key and wearing a black cloth hood. Two gunners are seated on either side of the barge, with a pilot at the front, all made of solid rubber. The gun positions and Skeletor's head are all rigged to move, although the mechanics have not been tested.

Several elements of the barge can be lit up: the pilot console buttons are back-lit, the throne platform glows white, and the rear engine and chassis all glow red, powered via a UK 13-amp plug. The model is presented on a black wooden board with a museum-style plaque detailing the item. It remains in very good condition, with two detached cannons that are included in the lot.

Dimensions: 120 cm x 90 cm x 64 cm (47" x 35" x 25")

This item contains electronic and mechanical components. While every effort is made to describe them accurately, no guarantee or warranty is made as to the functionality, lifespan or safety of those components. It is entirely incumbent on the new owner to satisfy themselves as to their safe use and maintenance.

£8,000-12,000



316. Trinity's (Carrie-Anne Moss) Dual Holstered Beretta 84FS Stunt Pistols Ω

THE MATRIX (1999)

Trinity's (Carrie-Anne Moss) dual holstered Beretta 84FS Cheetah stunt pistols from The Wachowskis' sci-fi film *The Matrix*. Trinity kept two Berettas holstered at the hip whenever she ventured into the Matrix.

The Berettas are constructed from solid resin with holes drilled into the barrels to signify their use was intended as holstered versions, as per Australia's strict gun laws; having the holes present in the prop firearms allowed the actors to handle the guns on the Sydney-based set without an armourer present.

The prop guns rest in leather holsters that buckle behind the grip and include metal clips for attaching to a belt. The set shows minor wear due to production use, but remains in very fine condition. Dimensions (each): 18.5 cm x 13.5 cm x 5 cm (7 1/4" x 5 1/4" x 2")

Ownership of the stunt pistols in this lot is restricted for UK residents to registered re-enactors, galleries or individuals in film, television or theatre production. Please enquire for further details. It is solely the buyer's responsibility to check, prior to bidding, the legal status of this prop within their own country and its importation therein.

£3,000-5,000

317. Neo's Stunt Trousers Ω

THE MATRIX (1999)

Neo's (Keanu Reeves) stunt trousers from the Wachowskis' sci-fi film *The Matrix*. Neo (Keanu Reeves) wore his black trousers when he and Trinity (Carrie-Anne Moss) fought to save Morpheus (Laurence Fishburne) from the Agents, notably during the iconic "bullet-time" dodge scene on the rooftop.

The black trousers are made from cotton and feature nylon stripes down and across each leg, as well as at the rear. The trousers can be fastened via zipper and hook-and-bar closures, and have a sewn-in label with "Neo Stunt" handwritten on it in fading ink. Also included is a wardrobe tag that has the waist and inseam measurements written on it, as well as "MTX-NEO3". The trousers show minor wear from production use and age, but remain in very good overall condition.

£4,000-6,000



318. Trinity's (Carrie-Anne Moss) Beretta 92 Compact Stunt Pistol M

THE MATRIX RELOADED AND THE MATRIX REVOLUTIONS (2003)

Trinity's (Carrie-Anne Moss) Beretta 92 compact stunt pistol from the Wachowskis' sci-fi action sequels *The Matrix Reloaded* and *The Matrix Revolutions*. Trinity used her pistols throughout the two movies, notably pointing one at Persephone (Monica Bellucci) when she lusted after Neo (Keanu Reeves), and against the guards in the club when she confronted The Merovingian (Lambert Wilson).

The weapon is a highly detailed mould of one of Trinity's hero Berettas used in the film, constructed from solid rubber with metal inserts to give it a more realistic weight. Stunt pistols would have been used when it wasn't necessary to use the hero versions.

The Beretta was originally acquired from weapons co-ordinator Robert "Rock" Galotti, and is accompanied by a Certificate of Authenticity from him. Dimensions: 20 cm x 4 cm x 13 cm (8" x 1 1/2" x 5")

Ownership of the stunt pistol in this lot is restricted for UK residents to registered re-enactors, galleries or individuals in film, television or theatre production. Please enquire for further details. It is solely the buyer's responsibility to check, prior to bidding, the legal status of this prop within their own country and its importation therein.

£2,000-3,000



319. Alien Son (Verne Troyer) Animatronic Costume US

MEN IN BLACK (1997)

The alien son (Verne Troyer) animatronic costume from Barry Sonnenfeld's sci-fi comedy *Men in Black*. Newly recruited into the *Men in Black*, Agent J (Will Smith) saw the alien son and his father standing in the customs line at MiB HQ, just behind the giant Arquillian (Carel Struycken).

The costume is made of foam latex and consists of a full-head mask, a bodysuit, arm sleeves and feet appliances. The mask is outfitted with electronic components which allowed puppeteers to control the character's blinking eyes and snout movement, although the mechanisms no longer work and the foam has become brittle. The costume exhibits wear to the foam, which has hardened and deteriorated in some areas, particularly on the spine and at the ends of the arm sleeves. The costume remains in fair condition.

Dimensions: 43 cm x 46 cm x 84 cm (17" x 18" x 33")

This item contains electronic components. While every effort has been made to describe them accurately, no guarantee or warranty is made as to the functionality, lifespan or safety of those components. It is entirely incumbent on the new owner to satisfy themselves as to their safe use and maintenance.

£3,000-5,000



320. Agent J's (Will Smith) Light-Up Noisy Cricket Ω

MEN IN BLACK (1997)

Agent J's (Will Smith) light-up Noisy Cricket from Barry Sonnenfeld's sci-fi action comedy *Men in Black*. Not trusting his partner with a heavy firearm, Agent K (Tommy Lee Jones) issued Agent J the Noisy Cricket, a palm-sized weapon that launched a very large orb of energy. The Noisy Cricket was Agent J's signature introductory weapon, and made an appearance in the sequel due to its popularity.

Made of aluminium, this light-up version features 10 cylindrical vents on the receiver, which houses the casing for the battery-powered lights. Under the hammer is a small on/off switch which activates the green light. The Noisy Cricket also features a humorously small grip and barrel.

Accompanying this lot is a letter of authenticity from the creator of the prop, Ricardo Angel Gamez. The prop firearm shows minor wear due to production use and age, with the hammer sympathetically reattached. The lot remains in very fine condition. Dimensions: 12 cm x 8 cm x 4 cm (4 3/4" x 3" x 1 1/2")

This item contains electronic components. While every effort has been made to describe them accurately, no guarantee or warranty is made as to the functionality, lifespan or safety of those components. It is entirely incumbent on the new owner to satisfy themselves as to their safe use and maintenance.

£8,000-12,000

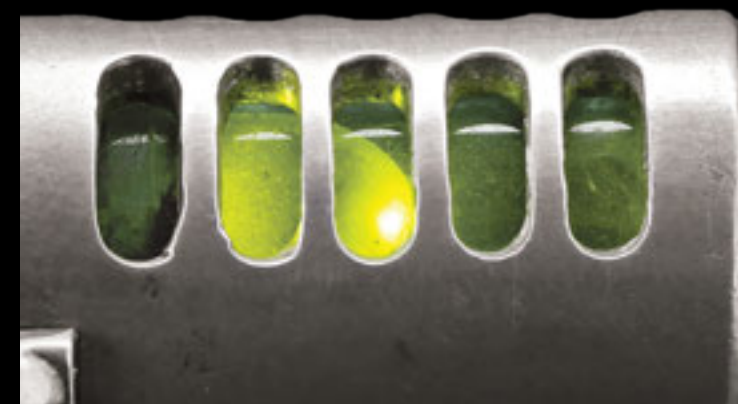

321. Agent J's (Will Smith) Light-up Neuralyzer Ω

MEN IN BLACK II (2002)

Agent J's (Will Smith) light-up Neuralyzer from Barry Sonnenfeld's sci-fi sequel *Men in Black II*. The Neuralyzer was a key tool used by MiB Agents to wipe the memory of citizens who knew too much about alien life on Earth. Agent J inherited his Neuralyzer from his former partner, Agent K (Tommy Lee Jones) and used the device in numerous scenes.

Made of aluminium, this light-up version features a cylindrical ribbed case with a spring-loaded interior. The pop-up interior, which is controlled via a clip on the exterior of the case, features three dials for the month, day and year settings. On the side of the device is a small black button that powers the lights, which when depressed in the closed position turns the lights off. Pressing the centre dial directs all power to the blue LED light at the top of the device, causing it to increase its intensity. Accompanying this lot is a letter of authenticity from the creator of the prop, Ricardo Angel Gamez. The prop shows some wear due to production use and age, but remains in very fine condition.

Dimensions: 23 cm x 3 cm x 3 cm (9" x 1 1/4" x 1 1/4")

This item contains electronic components. While every effort has been made to describe them accurately, no guarantee or warranty is made as to the functionality, lifespan or safety of those components. It is entirely incumbent on the new owner to satisfy themselves as to their safe use and maintenance.

£10,000-15,000



322. Taranbee Assassin Mask Ω

MEN IN BLACK 3 (2012)

A Taranbee assassin mask from Barry Sonnenfeld's sci-fi sequel *Men in Black 3*. Agent J (Will Smith) eliminated the Taranbee assassin when it launched an attack in Wu's Chinese restaurant.

Designed by legendary make-up artist Rick Baker, this humanoid alien mask is made of silicone, and features skin that appears to be melting, with numerous wrinkles and sagging areas of flesh. The mask has holes at the eyes, nose, mouth and ears for the actor's comfort. Showing minor wear due to production use, the mask remains in very fine condition. Dimensions: 25.5 cm x 25.5 cm x 20 cm (10" x 10" x 8")

£1,000-1,500

323. Michael Jackson Animatronic Transformation Head Ω

MICHAEL JACKSON'S MOONWALKER (1988)

A Michael Jackson animatronic transformation head from his anthology musical *Moonwalker*. When ambushed by Mr. Big (Joe Pesci) and his soldiers, Michael transformed into a spaceship. This mask comes from the early stages of Michael's transformation.

Created by Rick Baker's Cinovation Studios, the head is made of fibreglass with interior electronics that controlled the eyelids and illuminated the eyes. The back of the head is open, allowing easy access to the cables and internal servos. The head is screwed to a metal support beam with a metal base and includes an original production wooden storage box.

Showing minor wear due to production use and age, the head remains in very fine condition. Dimensions (head only): 18 cm x 21 cm x 23 cm (7" x 8 1/4" x 9"); (in crate): 24 cm x 38 cm x 47 cm (9 1/2" x 15" x 18 1/2")

£4,000-6,000



324. Spike's (Michael Jackson) Speed Demon Costume M**MICHAEL JACKSON'S MOONWALKER (1988)**

Spike's (Michael Jackson) costume from musical anthology *Moonwalker*. Directed by Academy Award®-winner Will Vinton, the "Speed Demon" segment saw Jackson disguise himself as Spike the rabbit in an attempt to hide from a mob of fans and paparazzi.

The costume comprises a rabbit head, a biker jacket, a shirt, a pair of trousers and two belts. The resin head is reinforced with linen mesh, with foam ears, large rabbit teeth and Michael Jackson's signature black hair. The jacket displays various decorative zips and buckles, which are oversized to appear cartoon-like. The buckles are finished in faux-silver and gold-coloured paint; however, most of the gold paint has been worn away over time, leaving the bright green undercoat visible. The yellow trousers feature matching decorative zips and buckles, with two brown belts worn over the top, also with oversized buckles and studs.

The jacket, shirt and trousers have been decorated with paint to match the bold visual style of the segment's stop-motion Spike rabbit. The costume shows significant cracking to the jacket and ears of the head as a result of age but remains in good overall condition. Dimensions (rabbit head): 51 cm x 43 cm x 41 cm (20 ¼" x 17" x 16 ¼")

£10,000-15,000

**325. Annie Wilkes' (Kathy Bates) Costume** Ω**MISERY (1990)**

Annie Wilkes' (Kathy Bates) costume from Rob Reiner's horror adaptation *Misery*. Rescued from a car accident, famous author Paul Sheldon (James Caan) is imprisoned by a nurse who has an unhealthy obsession with his work. Annie wore her dull grey turtleneck and dark plaid pants at the end of the film when Paul made his last attempt at escape.

The light grey turtleneck is made of cotton and the back features a long Velcro closure from the neck to the mid-back. The baggy pants are made of dark grey wool, with blue and green stitching that crosses to make a plaid pattern. Also included are Annie's long grey socks and a pair of prop pill wrappers that remained in the pockets after the production. A production wardrobe tag is paired with the costume that reads '#781 Kathy Bates.' The costume remains in very fine condition.

£2,000-3,000

**326. Miss Peregrine's (Eva Green) Pipe** M**MISS PEREGRINE'S HOME FOR PECULIAR CHILDREN (2016)**

Miss Peregrine's (Eva Green) pipe from Tim Burton's time-warp fantasy *Miss Peregrine's Home for Peculiar Children*. The ymbryne smokes her pipe throughout the film, notably during the scene in which she reveals Mr. Barron's (Samuel L. Jackson) hollowgast history to Jake (Asa Butterfield). The pipe is synonymous with Miss Peregrine's character, as described by Abe (Terence Stamp) at the beginning of the film.

Carved from wood, the pipe features a brown marbled resin stem and a foil-coated band. It was donated by 20th Century Fox for a charity auction and displays Fox's original identification code adhered to the underside of the bit. Presented on a metal stand, the pipe shows minor wear from the production, including small scratches to the foil band. Dimensions (displayed): 4 cm x 15 cm x 6 cm (1 ½" x 6" x 2 ½")

£1,000-1,500



327. "Gray Widower" Spider Puppet US

THE MIST (2007)

A "Gray Widower" spider puppet from Frank Darabont's adaptation of Stephen King's horror story *The Mist*. A band of strangers barricaded themselves in a grocery store when a freak storm unleashed otherworldly creatures into their quiet town. Other-dimensional spiders attacked the market survivors when they ventured outside to seek supplies. This puppet was used for the shot in which a Gray Widower stood on the hood of David Drayton's (Thomas Jane) car. A behind-the-scenes photograph shows director Frank Darabont filming this puppet on top of a car.

features eight legs protruding from the sides. Each leg is made of foam over a metal armature, with two joints allowing for articulation. The head features six eyes and acrylic human-like teeth.

The puppet is mounted on a support beam that runs through the body via the rear, and stands on two pieces of wood that are screwed together. The puppet shows minor wear to the foam, particularly around the leg joints, but the piece remains in very fine condition. Dimensions: 112 cm x 89.5 cm x 73.5 cm (44" x 32 1/4" x 29")

£4,000-6,000

Created by KNB EFX, the puppet consists of a hard resin torso, with a foam-latex head and legs. The rigid torso is outfitted with dozens of quills on its back, and

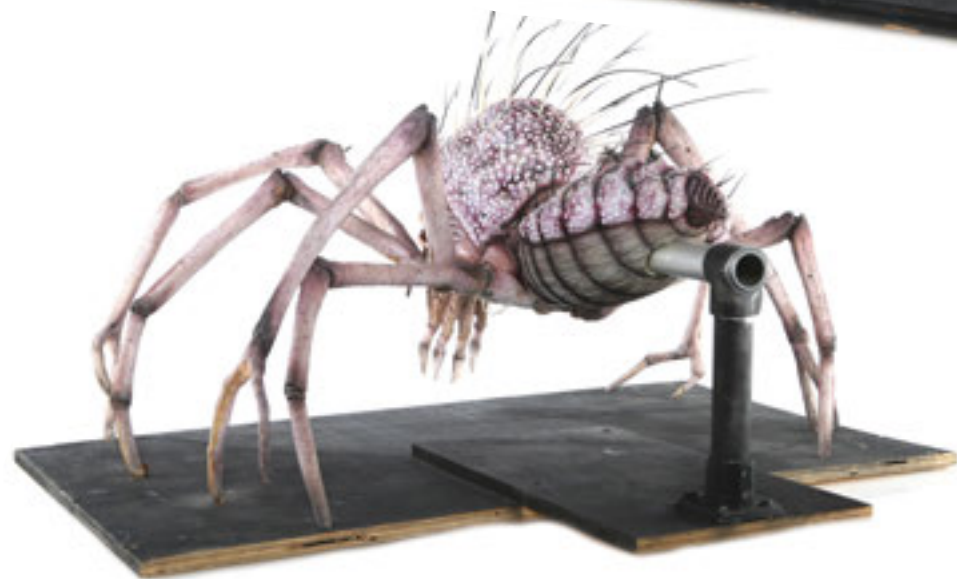
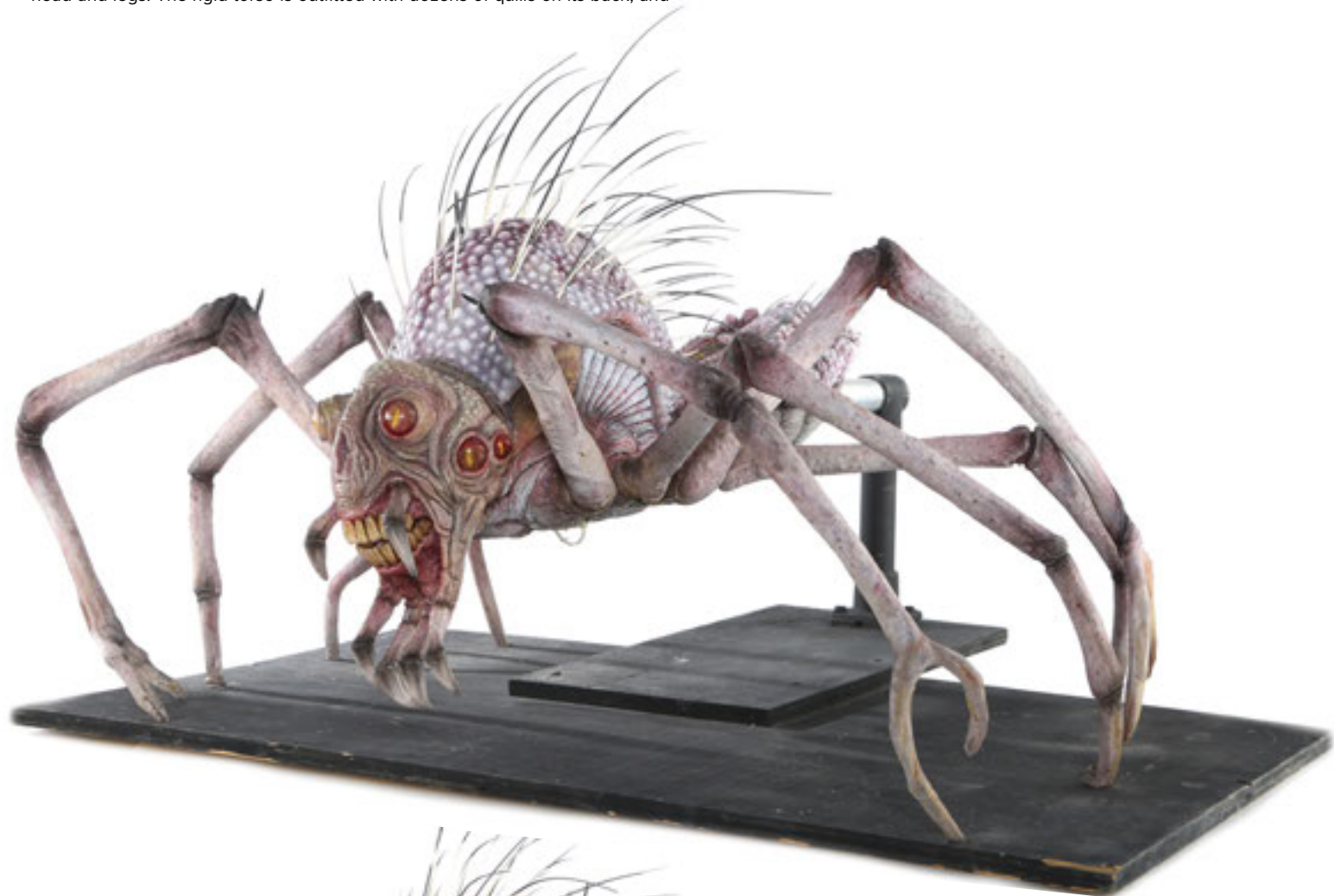

328. Animatronic 'Half' Bird Puppet US

THE MIST (2007)

An animatronic 'half' bird puppet from Frank Darabont's adaptation of Stephen King's horror story *The Mist*. A band of strangers barricaded themselves in a grocery store when a freak storm unleashed otherworldly creatures into their quiet town. Other-dimensional birds broke through the store windows when they attempted to feed on oversized insects and the people inside the market.

servos to control the eyes. The mouth features rows of pointed acrylic teeth, with the lower jaw split in half with a stretchy material bridging the gap. The mutant bird puppet shows minor wear to the foam, which has cracked in a few areas. However, the foam remains in very good overall condition.

The cable-controlled puppet is fully realised from the waist up, and consists of a soft foam-latex skin over a fiberglass form, with a wooden base and mount. The puppet is rigged with cable controls which operate the jaw, and electronic

servos to control the eyes. The mouth features rows of pointed acrylic teeth, with the lower jaw split in half with a stretchy material bridging the gap. The mutant bird puppet shows minor wear to the foam, which has cracked in a few areas. However, the foam remains in very good overall condition.

£3,000-5,000

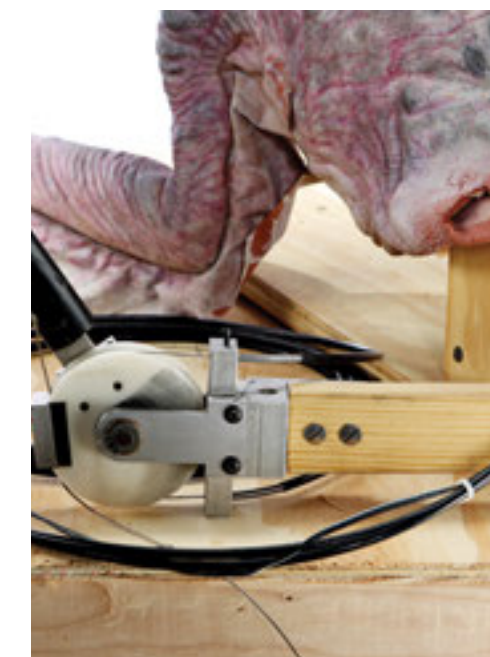



329. Knights Of The Round Table Helmet †Δ

MONTY PYTHON AND THE HOLY GRAIL (1975)

A helmet used in the cult comedy *Monty Python and the Holy Grail*. The Knights of the Round Table wore their helmets while dancing during a musical segue as Arthur (Graham Chapman) and his knights approached Camelot.

The helmet is cast in fibreglass with faux-rivet detailing, a 'T-shaped' opening and numerous drilled ear holes on each side. The inside is lined with foam which has yellowed with age and is labelled "40". A small pointed addition was added to the top of the helmet for a subsequent production and then partially removed. There are scuffs and chips to the paint from use and storage.

Dimensions: 28 cm x 24 cm x 36 cm (11" x 9 ½" x 14 ¼")

£800-1,200

330. Cast-Autographed Photograph M

MONTY PYTHON'S LIFE OF BRIAN (1979)

A cast-autographed photograph from the cult comedy *Monty Python's The Life of Brian*. Presented in a black frame, the black-and-white photograph shows the six members of the Monty Python troupe wearing the costumes of their most famous characters, posing for the camera in a Tunisian desert filming location.

Signed in black and blue pen, the photo displays autographs by John Cleese, Terry Gilliam, Terry Jones, Michael Palin, Graham Chapman and Eric Idle. The photo displays minor crease lines and the frame shows minor wear. Dimensions (framed): 27.5 cm x 33 cm x 1.5 cm (11" x 13" x ¾")

£800-1,200



331. GERTY Robotic Arm US

MOON (2009)

A GERTY robotic arm from Duncan Jones' sci-fi film *Moon*. Voiced by Kevin Spacey, GERTY was an artificially intelligent companion which assisted Sam Bell (Sam Rockwell) during his mining mission on Earth's moon. GERTY consisted of a mobile console with independent robotic arms that ran on a ceiling track, allowing it to perform various tasks and chores for Sam.

This robotic arm is made of hollow plastic, with faux access panels and two points of articulation for the arm. The piece is painted white and grey in colour, with faux dirt applied throughout, giving the piece a grimy, distressed appearance. The GERTY arm is decorated with sticker decals and shows the "LUNAR INDUSTRIES, INC." logo on both sides of the upper casing. The lot shows minor wear due to production use, but remains in very fine condition.

Dimensions: 76 cm x 28.5 cm x 119 cm (30" x 11 ¼" x 47")

£2,000-3,000

332. GERTY Docking Station US

MOON (2009)

A GERTY docking station from Duncan Jones' sci-fi film *Moon*. Voiced by Kevin Spacey, GERTY was an artificially intelligent companion that assisted Sam Bell (Sam Rockwell) during his mining mission on Earth's moon. GERTY's mobile console could dispatch from a docking station on a wall, and ran along a ceiling track throughout the station.

This docking station is made of hollow plastic over a wooden frame and is decorated with faux access panels and vent covers. The station is painted white and grey, with faux dirt painted throughout, giving the piece a grimy, distressed appearance. The GERTY docking station is decorated with sticker decals and warning labels. The lot shows some wear due to production use, with a few breaks to the plastic casing, but remains in good overall condition.

Dimensions: 72 cm x 46 cm x 124 cm (28 ¼" x 18" x 48 ¾")

£2,000-3,000



333. Long John Silver's (Tim Curry) Coat M

MUPPET TREASURE ISLAND (1996)

Long John Silver's (Tim Curry) coat from Brian Henson's musical comedy *Muppet Treasure Island*. The scheming cook wore his coat on the island as he searched for Captain Flint's (David Nicholls) treasure on the island with Jim (Kevin Bishop).

The frock coat is made from red felt and displays an ornate faux-gold embroidered floral and leaf-inspired pattern. Decorative gold-coloured buttons are attached down the front, on the cuffs and at the top of the pleating on the back. An Angels Costumes label is adhered in the collar reading "Tim Curry, April 1995". The coat displays signs of production use, including light plucks and minor damage and marks in the lining.

£600-800

334. Colonel Arbuthnot's (Sean Connery) Three-Piece Suit M

MURDER ON THE ORIENT EXPRESS (1974)

Colonel Arbuthnot's (Sean Connery) three-piece suit from Sidney Lumet's mystery film *Murder on the Orient Express*. Arbuthnot wore his suit in numerous scenes, notably when he was interrogated by Hercule Poirot (Albert Finney) over the murder of Ratchett (Richard Widmark).

The suit is made from brown tweed wool and comprises a jacket (marked "A3"), waistcoat (marked "3 A ½") and a pair of trousers (marked "36 x 37, A3"). Brown buttons are adhered to each component and the back of the waistcoat features an adjustable cinch. The trousers contain a Bermans & Nathans label. The suit displays signs of wear, including marks, minor discolouration and wear to the lining of each component.

£800-1,200





335. Aramis' (Santiago Cabrera) Costume †

THE MUSKETEERS (TV SERIES, 2014 - 2016)

Aramis' (Santiago Cabrera) costume from Adrian Hodges' adventure series *The Musketeers*. The playful musketeer wore his signature costume throughout the series as he faced down many threats against his country and its ruler King Louis (Ryan Gage).

The costume consists of a wide-brimmed hat, a brown leather overcoat, a white cotton shirt, trousers and arm armour. The grey felt hat features a brown leather band and a feather plume with the left brim shaped upwards. The right armguard, used to show the musketeers' rank, has a fleur-de-lis motif etched at the centre, with scratches applied.

A costumier's label marked "Aramis" is adhered to the collar of the shirt. The overcoat and trousers have handwritten labels, reading "DOBLE" (sic) and "DBL", inside. Distressed for use on the production, the costume shows leather wear throughout and staining around the shirt collar.

£2,000-3,000



336. Athos' (Tom Burke) Costume †

THE MUSKETEERS (TV SERIES, 2014 - 2016)

Athos' (Tom Burke) costume from Adrian Hodges' adventure series *The Musketeers*. The sincere musketeer wore his signature costume throughout the series as he served the French King Louis (Ryan Gage).

Primarily made from various shades of brown leather, the costume consists of a wide-brimmed felt hat, an overcoat, a white cotton shirt, trousers, knee-high boots, and the musketeers' trademark arm armour. The hat features a brown leather band with a black feather plume adhered to the side. Marking Athos' position within the musketeers, the armour displays intricate etched patterns with a fleur-de-lis shield at the centre, and production-applied scratches.

Costumier's labels are located inside the trousers, reading "Athos Hero", and within the armour and boots, marked "Athos DBL". The costume displays wear from use, including green stains around the collar of the shirt, missing buttons along the trousers' left leg and worn leather throughout.

£2,000-3,000



337. D'Artagnan's (Luke Pasqualino) Costume †

THE MUSKETEERS (TV SERIES, 2014 - 2016)

D'Artagnan's (Luke Pasqualino) costume from Adrian Hodges' adventure series *The Musketeers*. The musketeer-in-training wore his signature costume throughout the series as he proved his worth and valour to his comrades. Earning his place within the musketeers' ranks, D'Artagnan was rewarded the right armguard as a signifier of his honour and loyalty.

The costume consists of a wide-brimmed felt hat, a white cotton shirt, black leather trousers and brown leather arm armour, at the centre of which appears the fleur-de-lis motif. Completing the costume is a brown leather jacket, designed for formal use when the armour is not required. The hat features a light brown leather band with a large feather plume adhered to the side. "D'Artagnan DBL" is written inside the armour in black ink, and original costumier's labels are adhered inside the hat and trousers, reading "D'Artagnan 58" and "DBL". Distressed for use during production, the garments show leather wear and stains throughout.

£2,000-3,000



338. Porthos' (Howard Charles) Costume †

THE MUSKETEERS (TV SERIES, 2014 - 2016)

Porthos' (Howard Charles) costume from Adrian Hodges' adventure series *The Musketeers*. The spirited musketeer wore his signature costume throughout the series as he accompanied his comrades on their missions for King and country.

Featuring the musketeer-signifying right armguard, the costume is composed of a wide-brimmed black hat, an elaborate brown leather overcoat, a black cotton shirt, trousers and knee-high boots. Made from felt, the hat features a brown leather band and a feather plume with the left side turned up. The decorative armour displays a fleur-de-lis patch at the centre and brass-coloured details.

Original costumier's labels, reading "Porthos", are adhered to the inside of the shirt collar and trousers waistband. Distressed for use during production, the leather shows wear throughout, and stitch holes remain on the back seam of the trousers where they have been adjusted for the actor.

£2,000-3,000

339. Pickup Truck Model Miniature †Δ

NIGHTBREED (1990)

A pickup truck model miniature from Clive Barker's horror film *Nightbreed*. A miniature version of the vehicle was used for the shot in which the truck falls through the ground of the cemetery, into the underground city of Midian.

The exterior of the vehicle is crafted from plastic finished in beige paint, with cast-in detailing including the model number and make on the tailgate, which is picked

out in black. The truck features acrylic windows, two red petrol cans in the back, rubber tyres and a metal frame adhered to the roof. Heavily distressed for the production, the lot displays damage to the bonnet and comes with a spare bonnet piece and drive shaft. Dimensions: 50 cm x 20 cm x 21 cm (19 ¾" x 8" x 8 ¼")

£600-800



340. Midian Graveyard Miniature and Ralph McQuarrie Concept Design, Script, Paperwork and Poster †Δ

NIGHTBREED (1990)

A Midian graveyard miniature and collection of production materials from Clive Barker's horror film *Nightbreed*. Designed by revered conceptual artist Ralph McQuarrie, miniatures were used to adorn the top of gravestones and mausoleums in the graveyard above the monster city of Midian.

The miniature imp is made of fired clay and sat atop a polystyrene base, finished in blue-grey paint to resemble stone. It is accompanied by an original pencil-and-ink concept drawing of the piece, rendered by McQuarrie himself. Also included is a production-used script, a three-page model shoot summary and a U.S. one-sheet poster (G condition with minor scratches along the edges) mounted on white board. Bound in a black windowed card cover with split pins, the 134-page script is printed on A4 paper and includes pink and blue-coloured revisions. Production use is evident on the script, including a small tear at the top of the cover, and the wings are no longer present on the miniature.

Dimensions (miniature): 13 cm x 16 cm x 21.5 cm (5" x 6 ¼" x 8 ½")

Please note this lot is sold without copyright, reproduction rights, licensing agreements or any other type of legal releases.

£1,000-1,500



341. Barrel's Stop-Motion Mask Puppet Face M

THE NIGHTMARE BEFORE CHRISTMAS (1993)

Barrel's stop-motion mask puppet face from Henry Selick's musical *The Nightmare Before Christmas*. Oogie Boogie's henchman wore his skull mask in multiple scenes as he kidnapped "Sandy Claws" in collusion with his fellow trick-or-treaters Lock and Shock.

Multiple versions of the character's face were made for the production to capture different expressions and spoken words. Made of resin, the detachable face shows Barrel's wide, bared-teeth grin and small nose. His face is hand-painted a light blue-grey and his teeth are dull white, with black used to outline each tooth. Blue paint has been applied to the back, outlining Barrel's nostrils and eye sockets. The nose displays minor paint damage, and marks are present on the back from where the face would have been exchanged.

Dimensions: 7 cm x 6.5 cm x 3 cm (2 ¾" x 2 ½" x 1 ¼")

£2,000-3,000



342. Halloween Town Zombie Bass Player Stop-Motion Puppet Ω

THE NIGHTMARE BEFORE CHRISTMAS (1993)

A Halloween Town zombie bass player stop-motion puppet from Henry Selick's stop-motion musical *The Nightmare Before Christmas*. The Halloween Town band played music throughout the film, and were friends of Jack Skellington. The bass player wasn't much for words, but had a talking head inside his bass.

The puppet is made of foam over a metal animation armature, and is wearing a party hat which Halloween Town citizens wore on Christmas Eve, and when the band played during "Sally's Song". The puppet has a small head with a rotund body, long arms, short legs, and very large feet. Its foam body is cast with a black-striped burgundy suit with a white button-up shirt, a spider-shaped bowtie and white shoes.

The puppet stands freely on his own two feet, with flat metal supports that are embedded within each foot. Showing wear to the foam which has hardened and cracked due to age, the bass player's hands have become brittle. Although fragile, the puppet remains in fine condition. Dimensions: 19 cm x 14 cm x 26.5 cm (7 ½" x 5 ½" x 10 ½")

£4,000-6,000





343. Halloween Town Zombie Saxophone Player Stop-Motion Puppet Ω

THE NIGHTMARE BEFORE CHRISTMAS (1993)

A Halloween Town zombie saxophone player stop-motion puppet from Henry Selick's stop-motion musical *The Nightmare Before Christmas*. The Halloween Town band played music throughout the film, and were friends of Jack Skellington. The saxophone player is known for saying "Nice work, bone-daddy" after Jack Skellington completed his performance on Halloween.

The puppet is made of foam over a wire animation armature, and includes dried moss threaded through the scalp to resemble hair. The puppet features an elongated chin with a large wart, a bell-shaped torso and long slender arms and legs. It is cast with an integral black-striped burgundy suit with a white button-up shirt and white shoes.

The puppet stands on a simple wooden base and features wires protruding from the heels of its feet, which anchor it to holes in the base. Showing wear to the foam which has hardened and cracked due to age, the saxophone player is missing fingers on its left hand. Although fragile, the puppet remains in fine condition.

Dimensions (puppet): 9 cm x 10 cm x 26.5 cm (3 1/2" x 4" x 10 1/2"); (on base): 24 cm x 24 cm x 28 cm (9 1/2" x 9 1/2" x 11")

£4,000-6,000

344. Halloween Town Graveyard with Sally's Herb Patch US

THE NIGHTMARE BEFORE CHRISTMAS (1993)

A large section of the Halloween Town graveyard, featuring Sally's herb patch, from Henry Selick's stop-motion musical *The Nightmare Before Christmas*. The graveyard featured prominently during the song "Jack's Lament", when Jack strolled through the cemetery, with Sally watching him from a distance. At the end of the song, Sally took deadly nightshade from her herb garden so she could later drug Dr. Finkelstein.

This large section of graveyard is made of dense foam over a wooden frame, and features numerous gravestones, as well as two fences located on the hills. Detailed by hand, the scenery still includes faux snow layered on the graves and in the grooves of the ground. The hills are made of Styrofoam, and the two fences insert into place with metal wire. Sally's herb patch includes real plants and roots

which are rigid from paint. The set is supported from below by a wooden frame, which includes sticker labels that read "CEM+8 SALLY'S HERB PATCH".

The graveyard shows some wear to the materials due to production use and age, with one of the gravestone gargoyles sympathetically repaired. However, the lot remains in very fine condition.

Dimensions: 175 cm x 180 cm x 76 cm (69" x 71" x 30")

£5,000-7,000

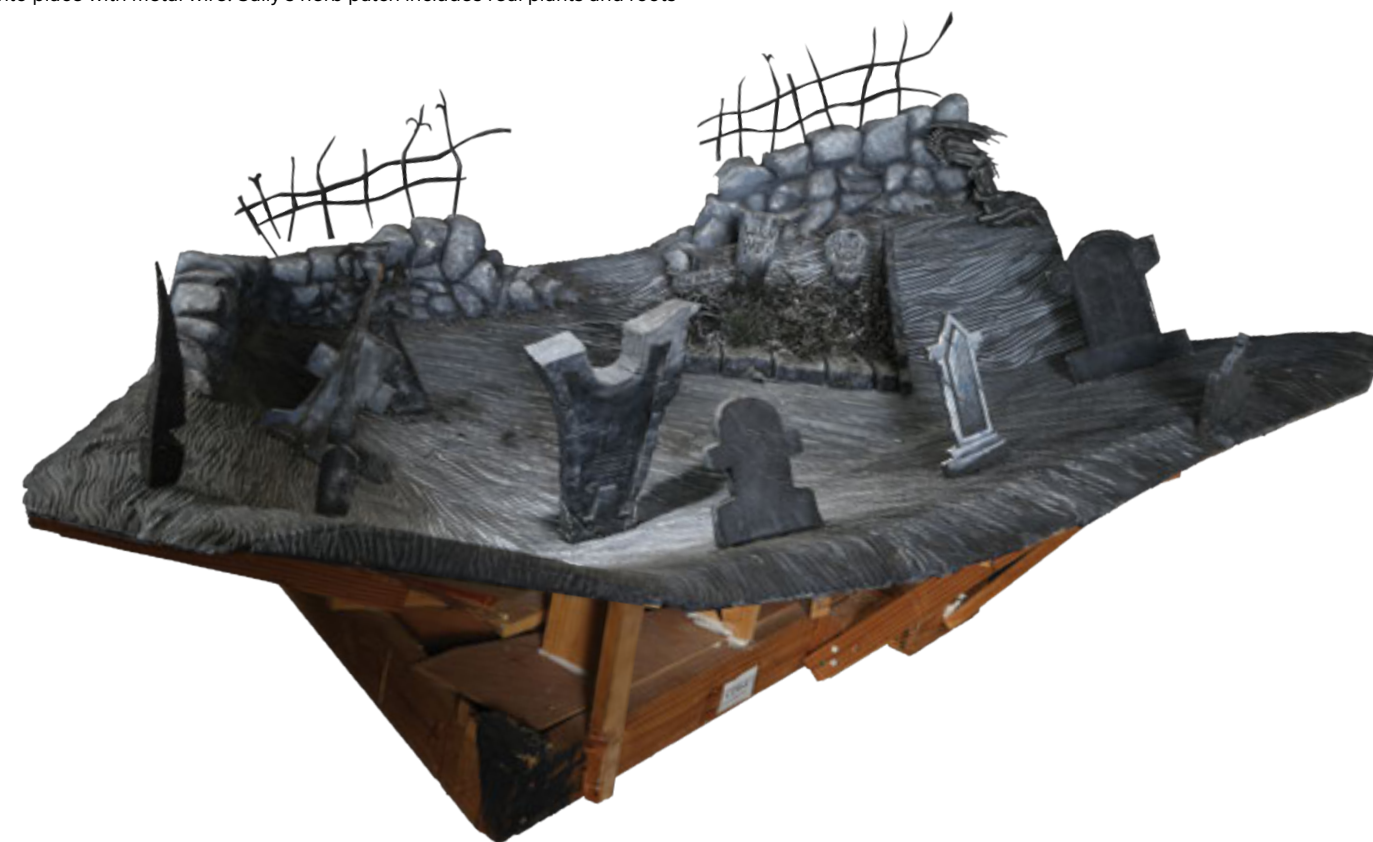

345. Raleigh Becket's (Charlie Hunnam) Hero Drivesuit Helmet Ω

PACIFIC RIM (2013)

Raleigh Becket's (Charlie Hunnam) hero Gipsy Danger drivesuit helmet from Guillermo Del Toro's monster movie *Pacific Rim*. This helmet is screen-matched to an FX shot in which Raleigh and his brother Yancy (Diego Klattenhoff) put on their drivesuits and their masks are drained of Relay Gel, a gold liquid that relays electrical impulses between the two pilots.

The light-up white helmet is made of fibreglass with vents at the sides, and has nozzles extending from the back. The clear plastic face guard is made of two pieces that allowed the Relay Gel to be pumped into, and drained from, the mask. The gold-coloured ear guards are made of metal and are connected to a series of servos that cause the ear pieces to spin back and forth when controlled by two spinning discs.

The lower back portion of the helmet is attached by magnets, allowing for easy access. Inside the helmet are LED light strips which are powered by eight AA batteries. Showing intentional production distressing, the helmet remains in very fine condition.

Dimensions (helmet): 20 cm x 25 cm x 28 cm (8" x 10" x 11"); (servos): 33 cm x 22 cm x 10 cm (13" x 8 1/2" x 3 3/4")

This item contains electronic and mechanical components. While every effort is made to describe them accurately, no guarantee or warranty is made as to the functionality, lifespan or safety of those components. It is entirely incumbent on the new owner to satisfy themselves as to their safe use and maintenance.

£12,000-15,000



346. Aurora Lane's (Jennifer Lawrence) Swimsuit M

PASSENGERS (2016)

Aurora Lane's (Jennifer Lawrence) swimsuit from Morten Tyldum's sci-fi drama *Passengers*. Lane wore her swimsuit in the pool of the colonisation ship Avalon as it experienced a temporary loss of gravity due to a critical system failure.

The swimsuit is made from white fishnet material, with a flesh-tone Lycra lining. The suit features a racer-style back, with a white zip running down the front. The lot is accompanied by a production wardrobe tag and displays light marks from use.

£1,500-2,500



347. Chimp Costume Ω

PLANET OF THE APES (1968)

A chimp costume from Franklin J. Schaffner's sci-fi classic *Planet of the Apes*. Astronaut George Taylor (Charlton Heston) crashed-landed on a future Earth that was dominated by an advanced ape civilisation. Chimps wore costumes such as this throughout the film.

The costume comprises a green tunic, a pair of matching green trousers and a pair of shoes. The green tunic features faux-leather panels at the shoulders, with additional faux-leather details on the arms. It closes at the back via a hidden zipper. In order to give the appearance of an undershirt, thick woven sleeves are sewn into the ends of the tunic's arms. A Western Costume tag is present inside the tunic and is labeled with "2771-1" and a chest size of 41. The trousers feature internal markings reading "2771-4", and a waist size of 34 from Western Costume.

The shoes are modified pairs of Sears Jeppers athletic shoes and are covered with matching green canvas fabric to appear as boots. Notably, the sole of each shoe is custom-shaped to appear as if it was made for ape feet. This costume shows minimal signs of wear and is in very fine overall condition.

£5,000-7,000

348. Gorilla Costume Display with Club and Rifle Ω**PLANET OF THE APES (1968)**

A gorilla costume display with club and rifle from Franklin J. Schaffner's sci-fi classic *Planet of the Apes*. Astronaut George Taylor (Charlton Heston) crashed on a future Earth dominated by an advanced ape civilisation. Gorillas wore costumes such as this throughout the film. This costume was also used for the subsequent films and television show in the *Planet of the Apes* franchise.

The dark brown vest is made of vinyl and has ribbed piping detail. It closes at the front via hidden snapping buttons and is worn over a purple canvas shirt, which matches a pair of purple canvas trousers. The costume also includes a pair of gloves and a pair of leather boots, which each have an ape-foot shaped toe box.

Each article of clothing has a Western Costume tag sewn in. The tag on the vest displays the production number "2954-1", while the trousers display the number "2954-3"; the shirt's tag displays a number that is no longer legible. Costume tags on the trousers are marked for stunt performer Ron Stein, while the shirt is marked for actress Erynn Mary Botelho.

The costume also comes with an original wooden club and an original rifle shell. The club attaches to a canvas bandolier via a clip. The rifle shell is an original piece, originally created for 1970 sequel *Beneath the Planet of the Apes*, and has an original leather strap. Made of metal, the shell is hand-painted with details that mimic wood grain and was designed to fit over an actual blank-firing rifle during the production. The bayonet, receiver and barrel are replica components added for completion.

This piece is displayed on a custom-made mannequin which has posable limbs. The mannequin also features a head which recreates the classic look of the gorillas from the films. The costume shows signs of wear throughout, including scuffs to the vest, cracking to the gloves and fading to the purple fabric. However, the piece remains in fine overall condition. Dimensions (display): 66 cm x 35.5 cm x 167.5 cm (26" x 14" x 66"); (rifle): 89 cm x 13 cm x 5 cm (35" x 5" x 2"); (club): 6.5 cm x 6.5 cm x 37 cm (2 1/2" x 2 1/2" x 14 1/2")

£12,000-15,000**349. Lieutenant Stewart's (Dianne Stanley) Liberty 1 Flightsuit** ΩΔ**PLANET OF THE APES (1968)**

Lieutenant Stewart's (Dianne Stanley) Liberty 1 flight suit from Franklin J. Schaffner's sci-fi classic *Planet of the Apes*. Lt. Stewart was the sole female astronaut aboard the doomed Liberty 1 expedition and was briefly seen alive at the start of the film while in cryosleep. Upon crash-landing 2,000 years later, Lt. Stewart was discovered deceased, having succumbed to old age due to a malfunction in her sleep pod. This costume was also worn for publicity photographs during production, and was likely reused in *Beneath the Planet of the Apes*, and the spinoff television series, each of which also featured Stewart.

This costume includes Lt. Stewart's ANSA flight jacket, trousers and a pair of boots. The jacket and trousers are made of nylon and polyester, and include Western Costume wardrobe labels stitched inside, each showing the name "Dianne Stanley". The double-breasted zip-up jacket features a leather nameplate that reads "Stewart", an embroidered ANSA patch over the right breast and a patch of the American flag over the left arm. The boots are made of leather and zip up at the front. The costume shows minor wear due to production use, but remains in fine condition.

£12,000-16,000

350. Armoured Chimp Costume Display ΔUS

PLANET OF THE APES (2001)

An armoured chimpanzee costume from Tim Burton's sci-fi remake *Planet of the Apes*. This lot consists of a helmet, a mask, a breastplate, a sleeved leotard, a pair of chimp gloves, an armoured skirt, a pair of woollen leggings, shin guards and ape shoes, and a bolas weapon.

The helmet, breastplate and shin guards are made of fibreglass, with soft padding in the helmet and chainmail at the rear, to cover the neck. Included is a latex chimp mask with hand-punched faux hair and eyes made of resin and acrylic. It is attached to the mannequin (detailed below) with Velcro.

The breastplate armour is worn over a wool-and-spandex leotard with leather sleeves. Dressing the legs are strips of leather and threaded wooden sticks. Worn on the hands is a pair of fur-covered spandex gloves with latex ape fingers.

The leggings are made of wool and spandex with patches of fur stitched along the legs. The two fibreglass shin guards have depictions of apes intricately carved into their facings, while the ape shoes feature urethane toes and have fur laid over the laces. The helmet is marked "Peter Deleal" and the shoes are marked "Jason Rodriguez". Also included is a bolas throwing weapon, which comprises three foam rocks bound with leather cords.

This costume is displayed on a soft poseable mannequin mounted to a styrofoam display base. The costume shows some wear due to production use, with the latex gloves and toes hardening due to age. However, it remains in good overall condition. Dimensions (on base): 71 cm x 51 cm x 188 cm (28" x 20" x 74")

£4,000-6,000



351. The TV Repairman's (Don Knotts) TV Remote Ω

PLEASANTVILLE (1998)

The TV Repairman's (Don Knotts) TV remote from Gary Ross' fantasy drama, *Pleasantville*. In the film, a mysterious TV repairman supplies a brother and sister with a magical remote control, which transports the pair into a 1950s family sitcom. This remote is one of two made for the film and screen-matches, via a mark on its side, to the scene in which the repairman gives the remote to David (Tobey Maguire).

Constructed of milled aluminium and plastic, this remote control features a small red light bulb at the top, with a red power button and white mute button. Additionally, there are three black faux buttons for volume, channel and contrast. The back of the device has a removable lid which houses the battery compartment and interior electronics. Inside this compartment the phrase "2 of 2" is hand-engraved, along with the initials J.W.R. The device requires four AA batteries to operate, but its electronics will need repairing in order for it to operate.

Accompanying the lot is a certificate of authenticity from New Line Cinema. There is minor cosmetic wear to the lettering, but this piece remains in very fine overall condition.

Dimensions: 23 cm x 5 cm x 5.5 cm (9" x 2" x 2 1/2")

This item contains electronic components. While every effort is made to describe them accurately, no guarantee or warranty is made as to the functionality, lifespan or safety of those components. It is entirely incumbent on the new owner to satisfy themselves as to their safe use and maintenance.

£2,000-3,000



352. Poltergeist Reference Hand M

POLTERGEIST (1982)

A poltergeist reference hand from Tobe Hooper's horror classic *Poltergeist*. Reference hands were used by the film's animators to help create the eerie visual effect during the scene in which Carol Anne (Heather O'Rourke) approached the television late at night and a ghost reached out of the screen.

Made from clear yellow-tinted acrylic, the hand features long, skeletal fingers stretching outward, with a piece of black tape adhered to the end of the wrist. Excess stretched acrylic extends over the wrist to make it look as though the hand is reaching through the screen. It shows evidence of wear from production use, including cracked edges on the covering acrylic and stains throughout. Dimensions: 22 cm x 15 cm x 10 cm (8 3/4" x 6" x 4")

£800-1,200



353. Production-Used Clapperboard M

THE PRISONER (TV SERIES 1967 - 1968)

A production-used clapperboard from the mystery sci-fi television series *The Prisoner*. The small wooden clapperboard features the series' title painted in white at the top and the names of the director Don Chaffey and cameraman Brendan Stafford beneath.

Boxes for inputting the scene, take and date references remain clear across the front. The reverse shows partially wiped chalk markings, which read "Leader". Well-used, the board shows signs of wear, including worn paint throughout and cracked edges. Dimensions: 2 cm x 23 cm x 15 cm (1" x 9" x 6")

£2,000-3,000



354. Big Kahuna Burger Bag M

PULP FICTION (1994)

A Big Kahuna Burger bag from Quentin Tarantino's Academy Award®-winning crime film *Pulp Fiction*. Big Kahuna Burger bags are visible in the scene where Jules Winnfield (Samuel L. Jackson) and Vincent Vega (John Travolta) paid a visit to Brett (Frank Whaley) at his apartment, after he double-crossed their boss Marsellus Wallace (Ving Rhames). The fictional Big Kahuna Burger brand is featured throughout many of Tarantino's films, including *Reservoir Dogs* and *Death Proof*.

The bag is made of white paper, with the colourful Big Kahuna Burger logo printed on both sides. A black logo reading "Stone 12" is printed on one side towards the top, with a recycling logo and serial number printed on the bottom. The bag displays signs of wear, including discolouration, creases and small tears as a result of use and age. Dimensions: 34.5 cm x 18 cm (13 ½" x 7 ¼")

£2,000-3,000



355. Frank Castle's (Thomas Jane) Costume and Dog Tags M

THE PUNISHER (2004)

Frank Castle's (Thomas Jane) costume and dog tags from Jonathan Hensleigh's comic-book adaptation *The Punisher*. Castle wore his costume as he sought to avenge the death of his family at the hands of crime boss Howard Saint (John Travolta), taking on a new identity as *The Punisher*.

The costume comprises a T-shirt, trousers and a pair of dog tags. The black cotton T-shirt displays the signature Punisher skull logo and the combat-style trousers feature multiple pockets and mesh detail on the legs. The metal dog tags are surrounded by black rubber and threaded onto a metal ball chain. Both tags are stamped with Castle's name, Social Security Number, blood type and religion. A handwritten label in the waistband of the trousers reads "#6, 35W" and the costume remains in very good condition.

£2,000-3,000

356. Mike Zeck and John Beatty Hand-Drawn Page 61 Artwork with Matching Colour Blue-line Ω

PUNISHER: RETURN TO BIG NOTHING (1989)

This lot contains the original hand-drawn pencilled-and-inked artwork by Mike Zeck and John Beatty, along with the matching hand-painted blue-line artwork by Phil Zimelman used to produce page 61 of *The Punisher: Return to Big Nothing* graphic novel. The top left panel was also used on the back cover of the graphic novel's hardcover publication.

The *Punisher: Return to Big Nothing* graphic novel was the first and only time the original creative team of the classic 1986 *The Punisher Limited Series* (Steven Grant, Mike Zeck and John Beatty) returned to the character. The *Punisher Limited Series* turned the vigilante, Frank Castle, from a supporting character into one of the most popular characters in the Marvel Universe during the 1980s. This particular story recounted Frank Castle's time in the military and his interactions with corrupt members of his unit. The first season of Netflix's *Punisher* television show was, in part, based on this storyline.

This original pencilled-and-inked page 61 artwork is rendered on Bristol board by penciller Mike Zeck and inker John Beatty. The full-colour version was painted in

airbrush and coloured inks by Phil Zimelman over a blue-line copy of Mike Zeck and John Beatty's art. An acetate overlay was created during production and placed over the colour artwork to complete the image. The artwork features three panels from the climax of the story, each showing The Punisher, as he confronts his adversary Sgt. Gorman.

Accompanying the lot is a reference hardcover copy of *The Punisher: Return to Big Nothing*, the comic book in which this art was originally published. Both artworks pair are in very good condition.

Dimensions (black and white): 43 cm x 28 cm (17" x 11"); (colour blue-line): 35.5 cm x 22 cm (14" x 8 ¾")

Please note this lot is sold without copyright, reproduction rights, licensing agreements or any other type of legal release.

£2,000-2,500



357. H.I. McDunnough's (Nicolas Cage) Diapers Ω

RAISING ARIZONA (1987)

H.I. McDunnough's (Nicolas Cage) diapers from Joel and Ethan Coen's crime comedy *Raising Arizona*. While he was stealing diapers, H.I. decided to rob the convenience store as well. He was pursued by the police while carrying the diapers.

This package of diapers is actually a block of Styrofoam covered in Huggies plastic wrapping, which has been resealed at the bottom with tape. The plastic shows some wear to the outside, including markings and holes throughout. This lot is in fine condition.

Dimensions: 35.5 cm x 23 cm x 38 cm (14" x 9" x 15")

£800-1,200



358. John Rambo's (Sylvester Stallone) Costume Ω

RAMBO (2008)

John Rambo's (Sylvester Stallone) costume from Sylvester Stallone's action sequel *Rambo*. The battle-hardened former Green Beret wore his Burma outfit when he attempted to rescue missionaries who were abducted by the Burmese military.

Rambo's costume includes an olive-coloured long-sleeve shirt, brown T-shirt, dark green cargo pants, and a pair of black leather boots. The buttonless long-sleeve shirt is made of linen and shows "#1" handwritten on the collar in black ink. The tattered T-shirt shows a bullet-hole on the left shoulder, which Rambo sustained while operating a Jeep-mounted M2 machine gun.

Rambo's cargo pants show a frayed tear at the left knee which is partially stitched together. The black leather Adidas boots show "SLY" handwritten in black ink on the tongue of the right shoe. Paired with the costume are two wardrobe tags that note the costume as "CHANGE 4" and "END STAGE AFTER BULLET HIT". Accompanying this lot is a certificate of authenticity from Stallone's official "Stallone - The Auction." The costume exhibits intentional production distressing, with dirt and grime throughout, but remains in very fine condition.

£2,500-3,000



359. Frank Thorne Hand-Drawn T-Shirt Artwork and Autographed Comic Book Ω

RED SONJA (1976)

Hand-drawn Red Sonja 1976 T-shirt artwork by Frank Thorne, and an autographed *Legends of Red Sonja* comic book. This original inked artwork is rendered on Bristol board by Frank Thorne. It was originally released as a T-shirt design in 1976 and was later published as the cover artwork for *Legends of Red Sonja* #4 in 2014.

The art shows Red Sonja leaning against her sword, with a dark sun behind her. The artwork is signed by Frank Thorne at the bottom right of the sun. Pasted over the artwork at the bottom left is a title block and copyright information.

Paired with the T-shirt artwork is a Frank Thorne autographed copy of *Legends of Red Sonja* #4, featuring the referenced artwork used for the T-shirt design. Also included is a printed photograph of actor Mark Hamill wearing the Red Sonja T-shirt. Some white-out correction fluid is present around the pasted title art and copyright information. However, the artwork remains in very good condition. Dimensions (artwork): 38 cm x 28.5 (15" x 11 1/4"); (comic): 26 cm x 17 cm (10 1/4" x 6 3/4"); (photograph): 18 cm x 14 cm (7" x 5 1/2")

Please note this lot is sold without copyright, reproduction rights, licencing agreements or any other type of legal release.

£5,000-7,000



360. Kryten's (Robert Llewellyn) 'Naked' Costume †

RED DWARF (TV SERIES 1988 - 2018)

Kryten's (Robert Llewellyn) 'naked' costume from the long-running BBC TV series *Red Dwarf*. Kryten appeared naked during a medical examination in the Season 8 episode "Back in the Red: Part 2", after he returned to the newly reconstituted Red Dwarf mining vessel only to find himself consigned to the ship's brig with the rest of the Starbug crew. Kryten appeared naked once again in the episode "Krytie TV" as he filmed the occupants of the women's showers.

Identical to Kryten's normal, black everyday "Series 4000 Mechanoid" robot costume, this special naked outfit is made of plastic covered in a pink cotton 'skin', with a production-used head in Kryten's trademark "amusing ice cube" shape. Hands and feet complete the costume, which is presented on a custom-made display. The hands show some paint flaking, but the costume is in good overall production-used condition. Dimensions (displayed): 32 cm x 67 cm x 145 cm (12 1/2" x 26 1/2" x 57")

£2,000-3,000



362. Carlos Olivera's (Oded Fehr) Umbrella Trooper Costume M

RESIDENT EVIL: APOCALYPSE (2004)

Carlos Olivera's (Oded Fehr) Umbrella trooper costume from Alexander Witt's action-horror sequel *Resident Evil: Apocalypse*. Carlos wore his costume throughout the film as he led his U.B.C.S. team against the zombies and attempted to escape Raccoon City.

The costume consists of a grey shirt (labelled "Carlos #6"); a black T-shirt; a tactical vest (labelled "Carlos, HP1") with drop leg holsters attached to the belt; elbow pads (labelled "6. Carlos"); leather fingerless gloves; and a pair of camouflage combat trousers. The tactical vest features two Umbrella insignias, and the name "Olivera" is embroidered on the back. The costume displays minor plucks, marks and glue residue on the T-shirt.

£800-1,200



363. Raccoon City Prop Collection and Poster M

RESIDENT EVIL: APOCALYPSE (2004)

A set of Raccoon City props and a poster from Alexander Witt's action-horror sequel *Resident Evil: Apocalypse*. After waking up in a laboratory, Alice (Milla Jovovich) found herself in Raccoon City, where she discovered the entire city had been infected.

The lot consists of an Umbrella Technology Group report page, a Raccoon City Times newspaper reporting on the suspension of police officer Jill Valentine (Sienna Guillory), an insignia patch worn by Umbrella soldiers, a Raccoon Ridge Academy patch and three Umbrella licence plates. The set is accompanied by a US one-sheet poster (G condition) mounted onto a board and showing Alice holding a pistol in a dystopian setting. Signs of wear from production use are present on the items, including fold lines, marks and minor cracks on the licence plates.

Dimensions (newspaper): 58 cm x 38 cm x 0.3 cm (23" x 15" x 1/4"); (poster): 102 cm x 67 cm (40 1/4" x 26 1/2")

£400-600



361. Virus Specimens and Poster M

RESIDENT EVIL (2002)

A set of virus specimens and poster from Paul W.S. Anderson's action horror *Resident Evil*. Antidote and virus specimens were stolen from the Hive during the opening scene.

The specimens consist of a transparent plastic core with two metal ends and central glass spiral tubes finished in blue and green. The U.S. one sheet poster (EX condition) shows an image of Alice (Milla Jovovich) and Rain (Michelle Rodriguez) with a criss-crossed sliced effect outlined with stitches. Mounted on a board, this poster design was chosen as the winner of a competition held by Sony Pictures.

The specimens show minor paint wear and one of the spirals contains a broken piece. Minor scuff marks are present on the edges of the poster. Dimensions (specimens): 12 cm x 3.5 cm x 3.5 cm (4 3/4" x 1 1/2" x 1 1/2"); (poster): 101 cm x 68 cm (39 3/4" x 26 3/4")

£600-800



364. Jill Valentine's (Sienna Guillory) Costume M**RESIDENT EVIL: APOCALYPSE (2004)**

Jill Valentine's (Sienna Guillory) costume from Alexander Witt's action-horror sequel *Resident Evil: Apocalypse*. The police officer wore her costume throughout the film as she, along with Alice (Milla Jovovich), attempted to escape Raccoon City and save the daughter of Dr. Ashford (Jared Harris).

The costume consists of a blue strapless top, a black miniskirt with a split at the front and decorative brown trim, and a grey long-sleeved jumper (marked size medium). Made from cotton, the top displays built-in strips of boning, visible lines of stitching and a zip fastening running down the back. Signs of production use are present on the costume, including a mark on the front of the top, and the zip fastening is broken.

£2,000-3,000**365. Alice's (Milla Jovovich) Costume M****RESIDENT EVIL: APOCALYPSE (2004)**

Alice's (Milla Jovovich) costume from Alexander Witt's action-horror sequel *Resident Evil: Apocalypse*. Alice wore her costume throughout the film as she guided Jill Valentine (Sienna Guillory), Carlos Olivera (Oded Fehr) and other survivors out of Raccoon City.

The costume consists of a khaki fishnet vest, an orange camisole vest (marked size small), a pair of black flared jeans and a pair of distressed black boots with buckle detailing. A label with the text "Hero Stage 1" handwritten in black is adhered to the inside of the jeans, and strips of white tape with "Alice 2nd" are stuck to the interior of the boots. There is a small rip on the front of the jeans, and some garments show minor wear from use on production.

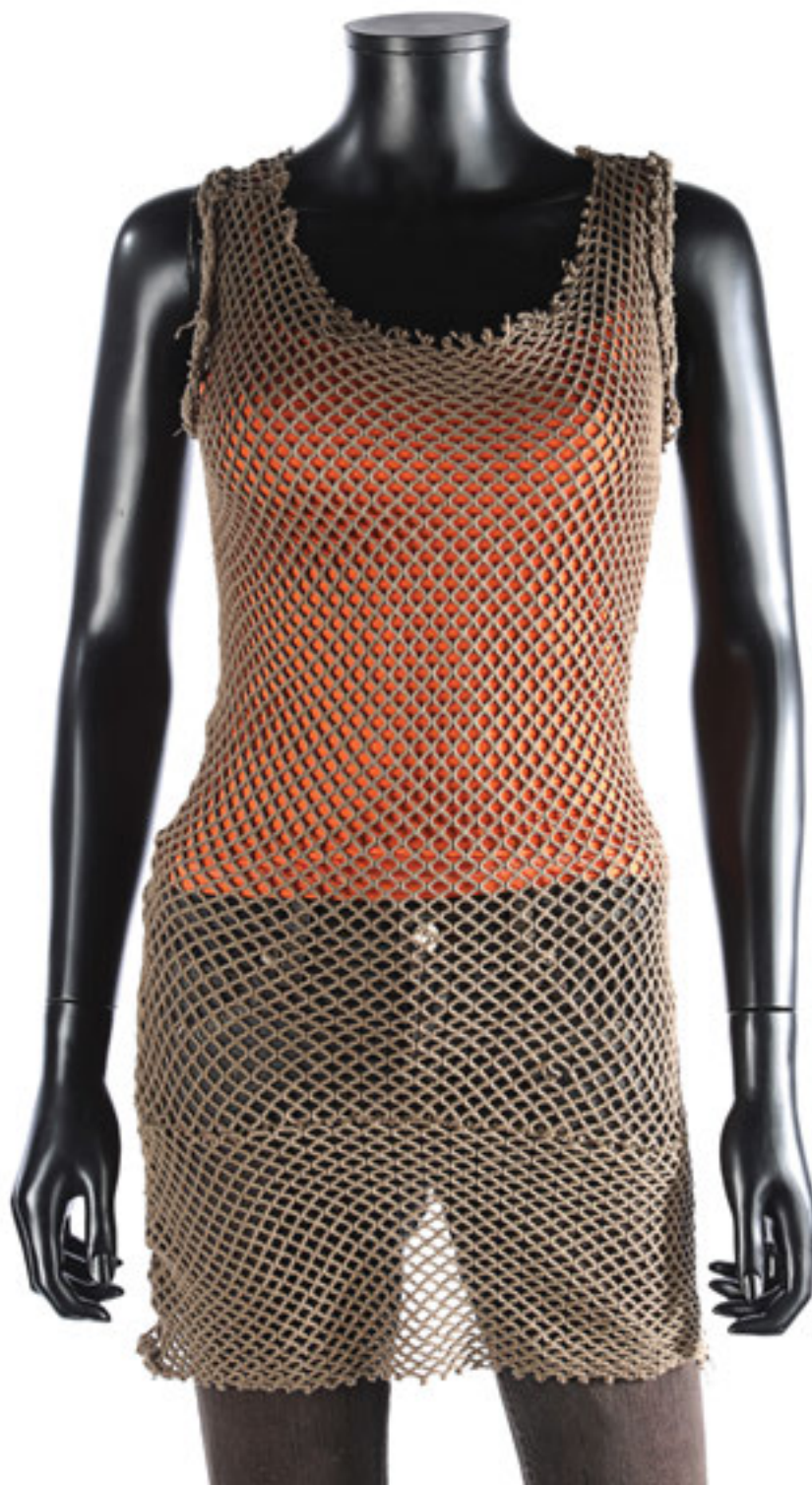
£3,000-5,000**366. Rob Roy MacGregor's (Liam Neeson) Coat and Kilt Costume Ω****ROB ROY (1995)**

Rob Roy MacGregor's (Liam Neeson) Highland costume from Michael Caton-Jones' historical drama *Rob Roy*. Rob Roy wore his tunic and kilt throughout the film, and wore a leather coat on the occasions he met with James Graham, 4th Marquess of Montrose (John Hurt), to negotiate the terms of a loan.

This costume includes Rob Roy MacGregor's coat, long tunic, shoulder sash with penannular brooch, kilt, belt, sporran (pouch), garter leg wraps and boots.

The open coat is made of leather, with sleeves that attach via cords. Roy's long tunic is made of soft linen, featuring ties at the neck and buttoned cuffs. A label stitched to the neck reads "LIAM". The two-piece kilt is made of wool with a brown-and-blue tartan pattern. Pinned to the shoulder sash is a heavy metal penannular brooch with four marble-sized gems embedded in the surface.

Also included are Rob's leather waist belt with a sporran, and a pair of leather leggings which slip on like sleeves and tighten with fastening cords. Handwritten with black pen inside one leg is "Liam". The costume exhibits some wear due to production use, but remains in fine condition.

£1,500-2,500**367. Will Scarlet's (Christian Slater) Wedding Jacket M****ROBIN HOOD: PRINCE OF THIEVES (1991)**

Will Scarlet's (Christian Slater) wedding jacket from Kevin Reynolds' action-adventure film *Robin Hood: Prince of Thieves*. Will wore his jacket in the end scene of the film as he witnessed the marriage of Robin of Locksley (Kevin Costner) and Marian (Mary Elizabeth Mastrantonio).

The jacket is made from mottled black woven fabric, with pieces of red and brown fabric embroidered with faux-gold thread, and its sleeves are loosely attached with red ties. Heavily distressed to produce a worn appearance, the front of the piece displays two red lion emblems, formed from a plastic-like material. The back displays a ribbed design and the garment displays intentional wear, with holes from production use.

£800-1,200

368. Will Scarlet's (Christian Slater) Tunic †Δ

ROBIN HOOD: PRINCE OF THIEVES (1991)

Will Scarlet's (Christian Slater) tunic from Kevin Reynolds' action-adventure film *Robin Hood: Prince of Thieves*. Will wore his tunic in multiple scenes, as he announced his true identity as Robin of Locksley's (Kevin Costner) half-brother and assisted him in defeating the Sheriff of Nottingham (Alan Rickman).

The garment comprises sections of heavily distressed black suede with leather binding, all joined together with red suede lacing pieces. Pleated detailing decorates the shoulders, and the front displays stitched red suede fabric, which has been formed into the shape of two adjacent lion emblems. The tunic displays holes and loose threads, adding to its intentionally tatty appearance.

£800-1,200

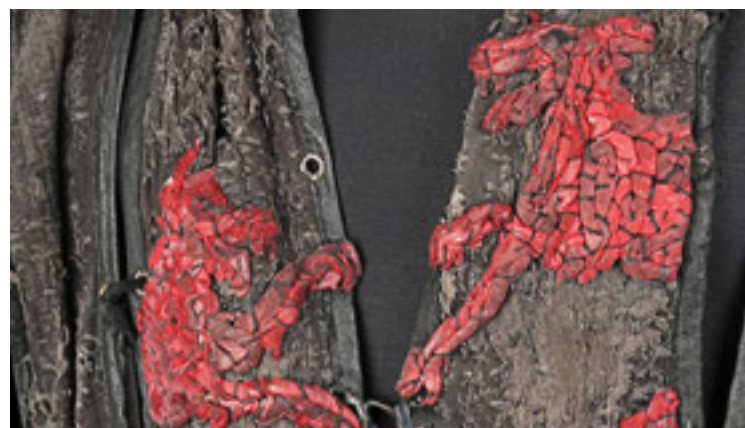

369. "A" Camera Clapperboard M

ROBIN HOOD (2010)

A production-used clapperboard from Ridley Scott's action-adventure *Robin Hood*. Clapperboards were used by the "A" camera unit during shoots.

Made from acrylic, the clapperboard has wooden clapper sticks mounted to the top, secured with a metal hinge. It features the film's working title "URHA" engraved in black at the top, and the names of director Ridley Scott and cameraman John Mathieson beneath. The slate displays handwritten black marker in the fields for the roll, scene and take, and is dated "1st July 2009", likely indicating the last time the board was used. Well-used, the clapperboard shows paint chips on the sticks' painted wood finish and surface scratches throughout.

Dimensions: 3 cm x 28.5 cm x 24 cm (1 1/4" x 11 1/4" x 9 1/2")

£800-1,200



370. Full-Size Battle-Damaged EM-208 ΔUS

ROBOCOP (2014)

A full-size battle-damaged EM-208 robot from José Padilha's 2014 reboot of *RoboCop*. Police officer Alex Murphy (Joel Kinnaman) was made into a cyborg following a critical injury. After becoming a cyborg, Murphy faced numerous EM-208 androids during a field test of his abilities.

This EM-208 is made of vacuum-formed plastic and resin components. The plastic components are filled with biscuit foam in order to add to the structural integrity of each piece. Additionally, wooden pegs are present, which join the arms to the body. The EM-208 has damage to its head in the form of a large hole, caused by a well-aimed shot from *RoboCop*. Numerous wires protrude from the hole in order to reveal the extent of the damage to the robot.

This piece is presented on a bespoke stand, which enables the EM-208 to be displayed in an upright position. The stand is made from metal poles attached to a wooden base. This piece shows some signs of wear from use, including markings on the back from being on the ground for filming, and is in fine overall condition.

Dimensions (on stand): 90 cm x 90 cm x 185 cm (35 1/2" x 35 1/2" x 73")

£4,000-6,000



371. The Rocketeer's (Bill Campbell) Bullet-Hit Helmet Ω

THE ROCKETEER (1991)

The Rocketeer's (Bill Campbell) bullet-hit helmet from Joe Johnston's period superhero film *The Rocketeer*. Cliff Secord's Rocketeer helmet displayed bullet damage during the climactic zeppelin sequence.

Created by DesignSetters Corporation, the helmet is made of Alumillite resin and features tinted eye lenses, a quilted helmet liner and a leather chinstrap within. An arrangement of metal nuts — which Campbell was not particularly fond of during filming — holds the helmet's eye lenses in place. The helmet is primed with grey

automotive lacquer, and spray painted with gold and brass paint. Distressed to appear well worn, with a bullet dent above the left eye that continues onto the stabiliser fin.

Accompanying this lot is a letter of authenticity from the DesignSetters model shop supervisor, Michael Stuart. The helmet shows minor wear due to production use, but remains in very fine condition. Dimensions: 46 cm x 20 cm x 30 cm (18" x 8" x 12")

£20,000-30,000



372. John Bell Hand-Coloured and Modified Rocketeer Concept Artwork Ω

THE ROCKETEER (1991)

A set of John Bell hand-coloured and modified Rocketeer Concept Artwork from Joe Johnston's period superhero film *The Rocketeer*. Bell served as the visual effects art director at Industrial Light & Magic, and oversaw the studio's work on the film.

Each of these three pieces are rendered on paper with pencil, pen and pastel. While each piece is a printed copy, hand-drawn and hand-coloured modifications are present to provide different design concepts for the design of the Rocketeer's Cirrus X3 rocket pack. The artist's signature is handwritten at the bottom right corner and each piece is numbered at the bottom left corner. The lot shows minor signs of wear from use, including pinholes at the corners, and is in very fine overall condition. Dimensions (each): 28 cm x 21.5 cm (11" x 8 1/2")



Please note this lot is sold without copyright, reproduction rights, licencing agreements or any other type of legal release.

£1,000-1,500

373. Niki Lauda's (Daniel Brühl) and James Hunt's (Chris Hemsworth) Formula 3 Balaclava and Goggles Set †Δ

RUSH (2013)

Niki Lauda's (Daniel Brühl) Formula 3 racing balaclava and goggles, with James Hunt's (Chris Hemsworth) goggles, from Ron Howard's Formula 1 racing biopic *Rush*. Lauda and Hunt wore their protective clothing at the Crystal Palace Formula 3 race track where their feud began. Made by Bob Heath Visors, Hunt's goggles feature an acrylic lens, rubber frame and dense foam liner. A black elastic wrap-around strap secures the visor in place and has a black clip at the rear.

Lauda's goggles, made by Halcyon, feature angled acrylic lenses to improve visibility, reinforced metal frames, a padded faux-leather lining and an elastic strap. The unsized white polyester hood has a single opening at the front and outward-facing stitching. Presented on custom display stands, the set remains in very good condition.

Dimensions (Lauda): 25 cm x 19 cm x 45 cm (9 3/4" x 7 1/2" x 17 3/4"); (Hunt): 25 cm x 19 cm x 26 cm (9 3/4" x 7 1/2" x 10 1/4")

£800-1,200



374. Niki Lauda's (Daniel Brühl) Crash Balaclava and James Hunt's (Chris Hemsworth) Bloody Fuji Racing Glove †Δ

RUSH (2013)

Niki Lauda's (Daniel Brühl) racing balaclava and James Hunt's (Chris Hemsworth) bloody racing glove from Ron Howard's Formula 1 racing biopic, *Rush*. Niki wore his balaclava at the devastating Nürburgring race that almost cost the legendary driver his life, while Hunt cut his glove and hand on a broken gear lever in his bid to battle the harsh conditions and win the final race of the season.

Made from cream polyester material, Lauda's unsized hood has a single opening for the eyes and outward-facing stitching. The areas around the eyes have been adorned with black and pink makeup to simulate the burnt appearance of Lauda immediately following the crash.

The red right-handed glove, manufactured by OMP from leather and fire-resistant aramid fibre, is dressed to appear dirty and bloodstained, with a tear to the palm. Both are presented on custom display stands. Dimensions (balaclava): 19 cm x 16 cm x 45 cm (7 1/2" x 6 1/4" x 17 3/4"); (mask): 16 cm x 19 cm x 35 cm (6 1/4" x 7 1/2" x 13 3/4")

£600-800



375. James Hunt's (Chris Hemsworth) Hesketh 308 Formula 1 Car †Δ

RUSH (2013)

A Hesketh 308 car made for James Hunt (Chris Hemsworth) in Ron Howard's Formula 1 racing biopic *Rush*. James Hunt's very first Formula 1 team was Hesketh Racing, owned and funded by Hunt's friend, Lord Hesketh (Christian McKay).

This vehicle is one of only nine prop cars built for the film; the remaining vehicles were genuine period race cars. The custom-built car is based around a Reynard Opel Lotus chassis with a fibreglass body, two-litre Vauxhall engine with a dry sump oil system, and a Reynard gearbox casing with Hewland five-speed H-pattern internals. The chassis was designed to accept many different exterior shells, allowing the same platform to serve as different vehicles in the film. These custom-built prop cars are highly authentic, and the mechanics working on *Rush* stated they had difficulty discerning the difference between the prop vehicles and the originals.

The car features a white finish and vinyl decals for Hunt's number, "24", Scottish and English flags, the team's name, and "James". No sponsor logos are present as the self-funded team famously did not believe in sponsors.

After completing the required scenes as Hunt's car, the body shell was redressed by the production team for driver Harald Ertl (Tom Wlaschiha), who also raced in a Hesketh. A new set of vinyl decals have since been produced and re-applied to restore it to its original form as Hunt's signature vehicle. The vinyl decals were created by the same vendor who created the originals for the film and are identical. The vehicle remains in very good condition.

Dimensions: 480 cm x 200 cm x 100 cm (189" x 79" x 39")

This car is substantially modified from its original engineering and should not be used to drive. It is sold in a static 'rolling only' condition, drained of all fluids and battery removed.

As this item is oversized it will require a specialist shipping service with additional costs. Please contact us prior to purchasing to request a quote.

£10,000-15,000



376. Full-Size Donner Animatronic Reindeer †

SANTA CLAUS: THE MOVIE (1985)

A full-size Donner reindeer from Jeannot Szwarc's festive adventure *Santa Claus: The Movie*. Donner appears throughout the film, with an animatronic version notably used for the scenes set in Santa's (David Huddleston) stables, in which the elf Patch (Dudley Moore) comforts and feeds the reindeer in his new dwelling.

Created by a team led by supervising animatronic designer John Coppinger, special-effects versions of the creatures were used to allow the team to have more control of the reindeer movements and prevent causing harm to any live animals.

The reindeer consists of an internal metal frame covered in sections of beige and brown synthetic fur, backed with leather and suede-like fabric. A set of flocked fibreglass antlers are adhered to its head and the reindeer exhibits detailed facial features, including acrylic eyes, a set of nostrils and an open mouth. Sporadic gold-coloured sequins decorate the creature's brown fibreglass hooves.

Intricately built to resemble one of Santa's flying companions, the reindeer contains an array of untested cables, wires and mechanisms to work its many functions. The head contains servo controls which caused facial movements such as blinking eyelids, and the torso and legs were operated by a pneumatic system. A metal cable runs from the inner body to one of the front hooves, and the reindeer is mounted on a custom-made stand with a small plaque featuring the film title and the text "Donner, Animatronic Reindeer". The lot has become fragile over time and displays minor wear to the flocked antlers and hooves, while metal has become slightly exposed on the nose.

Dimensions: 188 cm x 78 cm x 158 cm (74" x 30 3/4" x 62 1/4")

£6,000-8,000



377. Captain Miller's (Tom Hanks) Cast-Autographed Helmet M

SAVING PRIVATE RYAN (1998)

Captain Miller's (Tom Hanks) helmet from the Academy Award®-winning war drama *Saving Private Ryan*. Miller wore his captain's helmet throughout the movie, from the landing on Normandy's Omaha beach through to the final battle in the town of Ramelle, on his mission to rescue the titular Private James Ryan (Matt Damon)

The steel M1 helmet features a fibreglass liner with a green webbing chinstrap. Markings on the helmet include a painted set of captain's bars on the front, and the rear of the helmet has a number two within an orange diamond over a white line, signifying the wearer was an officer of the 2nd Ranger Battalion.

The olive green helmet has been autographed by director Steven Spielberg and cast members Tom Hanks, Matt Damon, Tom Sizemore, Adam Goldberg, Giovanni Ribisi and Jeremy Davies, with one other, unidentified signature.

This helmet was the star prize at a charity premiere held in Hatfield (the location for the majority of filming), on Tuesday 8th September 1998. The prize, donated by DreamWorks, was presented to the winner by Executive Producer Kevin De La Noy. Accompanying the helmet is ticket to the event and a printed program denoting it as the charity auction prize. Some corrosion is present within the helmet's liner, but it remains in very good overall condition.

Dimensions: 29cm x 23.5cm x 20 cm (11 1/2 x 9 1/4 x 8")

£10,000-15,000



378. Steven Spielberg's Director's Chair M

SAVING PRIVATE RYAN (1998)

Steven Spielberg's director's chair from his Academy Award®-winning war drama *Saving Private Ryan*. Director's chairs were used during the production by cast and crew members, with this chair designated for the film's director and producer, Steven Spielberg.

The frame of the foldable chair is made of wood, with a black linen seat and a side pocket, which is held to the armrest using metal press studs. The removable chair back is also made of black linen and reads "Steven Spielberg" on one side and "*Saving Private Ryan*" on the other in printed white text. The chair displays signs of wear from use, including light cracks to the text on the chair back and marks to the seat and side pocket.

Dimensions (unfolded): 64 cm x 57 cm x 118 cm (25 ¼" x 22 ½" x 46 ½")

£2,000-3,000



379. Matt Damon's Director's Chair M

SAVING PRIVATE RYAN (1998)

Matt Damon's director's chair from the Academy Award®-winning war drama *Saving Private Ryan*. Director's chairs were used during the production by cast and crew members, with this chair designated for Matt Damon in his role as the titular character, Private Ryan.

The frame of the foldable chair is made of wood, with a black linen seat and a side pocket, which is held to the armrest using metal press studs. The removable chair back is also made of black linen and reads "Matt Damon" on one side and "*Saving Private Ryan*" on the other in printed white text. The chair displays signs of wear from use, including marks and stains to the chair back, seat and side pocket.

Dimensions (unfolded): 64 cm x 57 cm x 118 cm (25 ¼" x 22 ½" x 46 ½")

£2,000-3,000



380. Tom Hanks' Director's Chair M

SAVING PRIVATE RYAN (1998)

Tom Hanks' director's chair from the Academy Award®-winning war drama *Saving Private Ryan*. Director's chairs were used during the production by cast and crew members, with this chair designated for Tom Hanks in his starring role as Captain Miller.

The frame of the foldable chair is made of wood, with a black linen seat and a side pocket, which is held to the armrest with a strip of Velcro. The removable chair back is also made of black linen and reads "Tom Hanks" on one side and "*Saving Private Ryan*" on the other in printed white text. The chair displays signs of wear from use, including marks and stains to the chair back, seat and side pocket.

Dimensions (unfolded): 64 cm x 57 cm x 118 cm (25 ¼" x 22 ½" x 46 ½")

£2,000-3,000



381. Franchise Continuity Binders and CDs Ω

**SAW II (2005)
SAW 3D: THE FINAL CHAPTER (2010)**

Continuity binders and CDs from *Saw II* through to the seventh film in the franchise, *Saw 3D: The Final Chapter*. This lot contains five binders and four CDs, all of which feature continuity photographs.

The five binders (one for each film, excluding the fifth) contain Polaroids and behind-the-scenes photographs, which show gore continuity on the actors as they shot various 'trap' sequences. While there is no binder for *Saw V*, there is a loose continuity binder cover page containing a single photograph. Additional photographs are saved to CDs, with two discs each for *Saw IV* and *Saw VI*. The set shows minor wear due to production use, but remains in fine condition. Dimensions (each binder): 27 cm x 29 cm x 2.5 cm (10 ½" x 11 ½" x 1")

Please note this lot is sold without copyright, reproduction rights, licensing agreements or any other type of legal release.

£1,000-1,500



382. Knife Chair Trap ΔUS**SAW IV (2007)**

The Knife Chair trap from Darren Lynn Bousman's horror sequel *Saw IV*. Chronologically the first trap made by the serial killer John Kramer (Tobin Bell), the Knife Chair trap was prepared for Cecil Adams (Billy Otis), a drug addict who caused the miscarriage of Kramer's unborn son. The chair screen-matches to the scene in which Cecil Adams attempts to escape the trap.

The trap consists of a wooden chair that is rigged with a pressure plate, forcing the victim to press his face through eight horizontal knives in order to escape. The removable knife rig is made of steel bars and slides into a base attached to the back of the chair. The hinged blades are made of urethane, and are dressed in faux blood from the gruesome sequence. The chair includes resin shackles and urethane blades at the arm rests.

Resting on a themed wooden display base, the trap shows minor wear to the restraints, but remains in very fine condition.

Dimensions: 63.5 cm x 124.5 cm x 164.5 cm (25" x 49" x 64 ¾")

£4,000-6,000

**383. Scott Pilgrim's (Michael Cera) Stunt Sword and Knives Chau's (Ellen Wong) Stunt Daggers Ω****SCOTT PILGRIM VS. THE WORLD (2010)**

Scott Pilgrim's (Michael Cera) stunt sword and Knives Chau's (Ellen Wong) stunt daggers from Edgar Wright's comic-book adaptation *Scott Pilgrim vs. the World*. Scott earned a pair of magical katanas when he confronted his girlfriend's new boyfriend (and previous ex) Gideon Graves (Jason Schwartzman). Scott's ex Knives attacked his new girlfriend Ramona Flowers (Mary Elizabeth Winstead) using her daggers.

Scott's katana features a blunt resin blade with one side padded with foam. The rounded guard and butt are made of aluminium and display the initials "SP". The long grip features an ito braid.

Knives' daggers feature long resin blades attached to aluminium s-guards, and have fire-breathing eagles cast into each side of the blades. The grips are wrapped with black ito braids.

The stunt sword shows scuffs to the paint, with most of the foam peeled away from the blade. The knives show wear to the paint finish due to production use, but remain in fine condition. Dimensions (sword): 99 cm x 8 cm x 8 cm (39" x 3" x 3"); (each knife): 69 cm x 15 cm x 4.5 cm (27" x 6" x 1 ¾")

£1,000-1,500

**384. Ghostface Mask Ω****SCREAM (1996)**

A Ghostface mask from Wes Craven's horror film *Scream*. The masked killer Ghostface hunted Sydney Prescott (Neve Campbell) and her friends on the anniversary of her mother's murder.

The production used two types of masks during filming: the opening murder utilised a design by effects studio KNB EFX, while later scenes used the commercial masks produced by Fantastic Faces. This mask is made by Fantastic Faces using soft PVC, with the shroud made of black cotton. Stamped under the chin is "Fantastic Faces DIV."

Accompanying the mask is a letter of authenticity attributing the piece to the property master. The mask shows minor yellowing to the PVC, but remains in very fine condition.

Dimensions: 29 cm x 16 cm x 8 cm (11 ½" x 6 ¼" x 3")

£6,000-8,000



385. Dave's (Gene Wilder) Waistcoat M**SEE NO EVIL, HEAR NO EVIL (1989)**

Dave's (Gene Wilder) waistcoat from Arthur Hiller's comedy *See No Evil, Hear No Evil*. Deaf store worker Dave wore his waistcoat in multiple scenes throughout the film as he and his blind companion Wally (Richard Pryor) were mistakenly arrested for murder.

Made from brown speckled linen, the front of the waistcoat is adorned with two pockets and six tortoiseshell buttons. The back of the garment is made from a beige silk-like fabric and features a cinch with a metal buckle. Marks are present on the back and signs of stitching — where a label has previously been attached — are present on the lining. The garment is accompanied by two production wardrobe tags.

£400-600

**386. River's (Summer Glau) Stunt Sword M****SERENITY (2005)**

River's (Summer Glau) stunt sword from Joss Whedon's sci-fi adventure film *Serenity*. River wielded her sword during the final battle sequence, in which she protected her fellow *Serenity* crew members from the Reavers, standing over them holding her bladed weapon as the Alliance troops arrived.

Made from rubber with a metal armature fitted within for rigidity, the sword features a serrated blade with a curved point and is finished in varying shades of faux-silver paint to replicate the appearance of metal. Sporadic cast-in line detailing is present on the blade and brown paint has been applied, producing a tarnished appearance. Plastic twine is wrapped around the grip and the pommel is finished in black. The sword has been intentionally distressed and displays light wear to the rubber pommel and paint finish on the blade from production use. Dimensions: 80 cm x 14 cm x 4.5 cm (31 1/2" x 5 1/2" x 1 3/4")

£2,000-3,000

**387. Mal's (Nathan Fillion) Red Shirt M****SERENITY (2005)**

Mal's (Nathan Fillion) shirt from Joss Whedon's sci-fi adventure *Serenity*. Mal wore his distinctive red shirt throughout much of the film, including the exciting Maidenhead Bar sequence, as he and his *Serenity* shipmates evaded the Alliance and protected telepathic crew member River Tam (Summer Glau).

Custom-made for the actor from wine-red cotton, the long-sleeve shirt fastens with two magnetic brass clasps at the front and on each cuff. Three hidden metal poppers at the front maintain a smooth line during wear. The shirt exhibits some slight sun-damage from age but remains in otherwise good condition.

£3,000-5,000

**388. Mal's (Nathan Fillion) Pistol M****SERENITY (2005)**

Mal's (Nathan Fillion) pistol from Joss Whedon's sci-fi adventure *Serenity*. The captain of the Firefly-class vessel *Serenity* carries his distinctive sidearm throughout the film as he and the crew evade capture by the Alliance. This is a static version for use when the hero firing weapon was not required.

the pistol is painted a burnished brass colour, with dark shadow effects making it appear well-used. The grip is decorated to look like wood. Some sections of paint have worn away from use, revealing the black rubber beneath.

Dimensions: 38 cm x 4.5 cm x 14 cm (15" x 1 3/4" x 5 1/2")

The weapon is modelled on a Taurus Model 85 revolver with some futuristic modifications to help it resemble a semi-automatic handgun, referred to as a "Moses Brothers Self-Defense Engine Frontier Model B". Made from solid rubber,

£6,000-8,000



389. Costume Continuity Binder †Δ**THE SHADOW (1994)**

A continuity binder from Russell Mulcahy's superhero film *The Shadow*. Continuity binders are created during the filming of a production and used as a detailed reference to assist the wardrobe department on set.

Dated 14 September, 1994, the first 13 pages display crew member lists and a department index. Much of the folder is divided into sections which contain sheets displaying the character name, scene number and description of the set. One hundred and forty-five original Polaroid photographs are attached to their corresponding sections, and numerous handwritten notes relating to costumes feature throughout. The binder also contains a revised script, which is credited to David Koeppe, dated 17 July, 1993 and comprises 119 US Letter pages printed on pink, white, blue and yellow paper. The paperwork displays signs of production use, including light folds, a detached front page and minor discolouration on some of the Polaroids. Dimensions: 29.5 cm x 28.5cm x 8 cm (11 3/4" x 11 1/4" x 3 1/4")

£1,000-1,500**390. Shivan Khan's (John Lone) Face Mask †Δ****THE SHADOW (1994)**

Shivan Khan's (John Lone) face mask from Russell Mulcahy's superhero film *The Shadow*. The archenemy of the Shadow wore his face mask as he emerged from Genghis Khan's sarcophagus and used hypnosis to force a security guard to shoot himself.

The mask is made from fibreglass with open eye holes, a distinctive nose and closed lips. It is finished in bronze-coloured paint. The interior of the mask features two strips of black foam adhered to the sides for comfort during wear. The lot displays minor surface scratches, paint wear and remnants of adhesive on the inside from production use. Dimensions: 17 cm x 15 cm x 9 cm (6 3/4" x 6" x 3 3/4")

£1,000-1,500**391. The Shadow's (Alec Baldwin) Tuxedo and Overcoat †Δ****THE SHADOW (1994)**

The Shadow's (Alec Baldwin) tuxedo and overcoat from Russell Mulcahy's 1930s-set superhero film *The Shadow*. In his millionaire playboy guise, the vigilante wore his smart attire during multiple scenes at a club where he dined with his uncle, Wainwright Barth (Jonathan Winters). He notably wore his overcoat when he stepped out of a taxi to say goodnight to Margo Lane (Penelope Ann Miller).

The tuxedo consists of a black double-breasted jacket which features textured lapels and multiple pockets, a cropped patterned waistcoat, a pair of trousers with a ribbed stripe running down the outside seams and two bowties. Made from coarse black cotton, the full-length overcoat displays two pockets, six large buttons on the front and a vent at the back. Minor stains are present on the jacket from production use and the overcoat buttonholes display some wear.

£1,500-2,500**392. Ellis 'Red' Redding's (Morgan Freeman) Inmate Uniform Ω****THE SHAWSHANK REDEMPTION (1994)**

Ellis 'Red' Redding's (Morgan Freeman) inmate uniform from Frank Darabont's prison drama *The Shawshank Redemption*. Red wore his inmate uniform throughout the film. This costume consists of Red's shirt, and a pair of background prisoner jeans.

Red's black-and-white striped shirt is made of 100% cotton and buttons up in front. The shirt features two chest pockets, and has a patch with Red's inmate number "30265" stitched above the left pocket. The inner collar is stamped with "W.C.C. #19".

The jeans are made of blue denim with a metal button-up fly, and include a label inside that reads "Western Costume". The costume shows minor wear due to production use, but remains in very fine condition.

£6,000-8,000

393. Ellis 'Red' Redding's (Morgan Freeman) Harmonica ΩΔ

THE SHAWSHANK REDEMPTION (1994)

Ellis 'Red' Redding's (Morgan Freeman) harmonica from Frank Darabont's prison drama *The Shawshank Redemption*. Convicted murderer Andy Dufresne (Tim Robbins) gifted a harmonica to his friend and fellow inmate Red.

This vintage harmonica is made of metal and is engraved with the Lancer Harmonica logo and title. The functioning instrument shows a slight curvature to the top cover plate, which has bent in slightly, but the harmonica remains in very fine condition. Dimensions: 10 cm x 2.5 cm x 2 cm (4" x 1" x ¾")

£2,000-3,000



394. Jack Torrance's (Jack Nicholson) Jacket M

THE SHINING (1980)

Jack Torrance's (Jack Nicholson) jacket from Stanley Kubrick's horror film *The Shining*. Torrance wore his jacket throughout much of the film, as he slowly descended into madness during the long winter spent with his family at the Overlook Hotel.

Created by Margaret Howell and designed by costume designer Milena Canonero, this jacket has an identical exterior to the one worn by Nicholson, and was made to be worn by lighting stand-ins and actor doubles, as well as used for distance filming and as a practical prop.

The custom-made blouson jacket is made from burgundy corduroy material with a brown woollen elasticated waistband. Small red buttons run down the front of the jacket and are covered by a placket, with matching buttons on the waist, breast pockets and cuffs. The jacket was personally gifted to one of the production's riggers by Jack Nicholson. They became good friends during the lengthy filming process and a photo album is included, containing shots of the crew member on set with Nicholson. A call sheet dated 12th September 1978 completes the collection. The costume piece displays general light wear and remains in excellent condition.

£5,000-7,000



396. Stanley Kubrick Autographed Photograph M

THE SHINING (1980)

An autographed promotional photograph of Stanley Kubrick. The black-and-white photograph shows a close-up of the legendary director at work behind the camera on the exterior Overlook Hotel set for *The Shining*. Written in purple ink and inscribed "Best Wishes", the image bears an earlier attempt at "wishes" which has been crossed out by Kubrick. The lower corners have suffered from water damage which has caused a loss of gloss finish to the image and copywrite text. Signature is unaffected. Dimensions: 25.5 cm x 20.5 cm (10" x 8")

£400-600



395. No Lot

No Lot



397. Johnny 5's Eyes †Δ

SHORT CIRCUIT (1986)

Johnny 5's eyes from John Badham's comedy sci-fi *Short Circuit*. Invented by Nova Robotics, Johnny 5 is the beloved robot who gained human-like intelligence after being struck by lightning. His distinctive camera-like eyes were designed to convey his emotions and amiable character.

Made of metal, the eyes feature brass rings with internal glass lenses. Housed within the lenses are functional black-plated camera apertures, which, when mounted to a remote-control rig during production, could be opened and closed to resemble the movement of an eye's iris.

Accompanying the eyes is an original cast-and-crew screening invitation dated "Friday, May 2, 8PM", as well as a small 3 ½" x 5" photograph depicting Johnny's head. There is some light wear to the metal components of the eyes and the paperwork shows minor stains and creases from age. Dimensions (per eye): 7.5 cm x 7.5 cm x 3 cm (3" x 3" x 1 ¼")

£2,000-3,000

398. Miniature Johnny 5 Robot Model M

SHORT CIRCUIT 2 (1988)

A miniature Johnny 5 robot model from Kenneth Johnson's comedy sci-fi sequel *Short Circuit 2*. Inventor Ben Jahveri (Fisher Stevens) street vended his miniature models of the lovable robot at the beginning of the film. One wandering Number 5 caught the attention of Sandy Banatoni (Cynthia Gibb) prompting her to order 1,000 of the toys, thus setting the plot of the film in motion.

The robot is made of cast resin with an array of twisted metal wires resembling cabling. It has a highly detailed paint finish, with various metallic blue panels and bronze-coloured buttons and components. It features two functional rubber continuous tracks at the front and a small wheel at the back. The model is poseable, with moving hinges on the shoulders, elbows, waist and tracks. The miniature shows evidence of production use and age, including paint wear and chips throughout, a tear across the right tread and a missing eyebrow component.

Dimensions: 26 cm x 22 cm x 41 cm (10" x 8 ¾" x 16")

£6,000-8,000

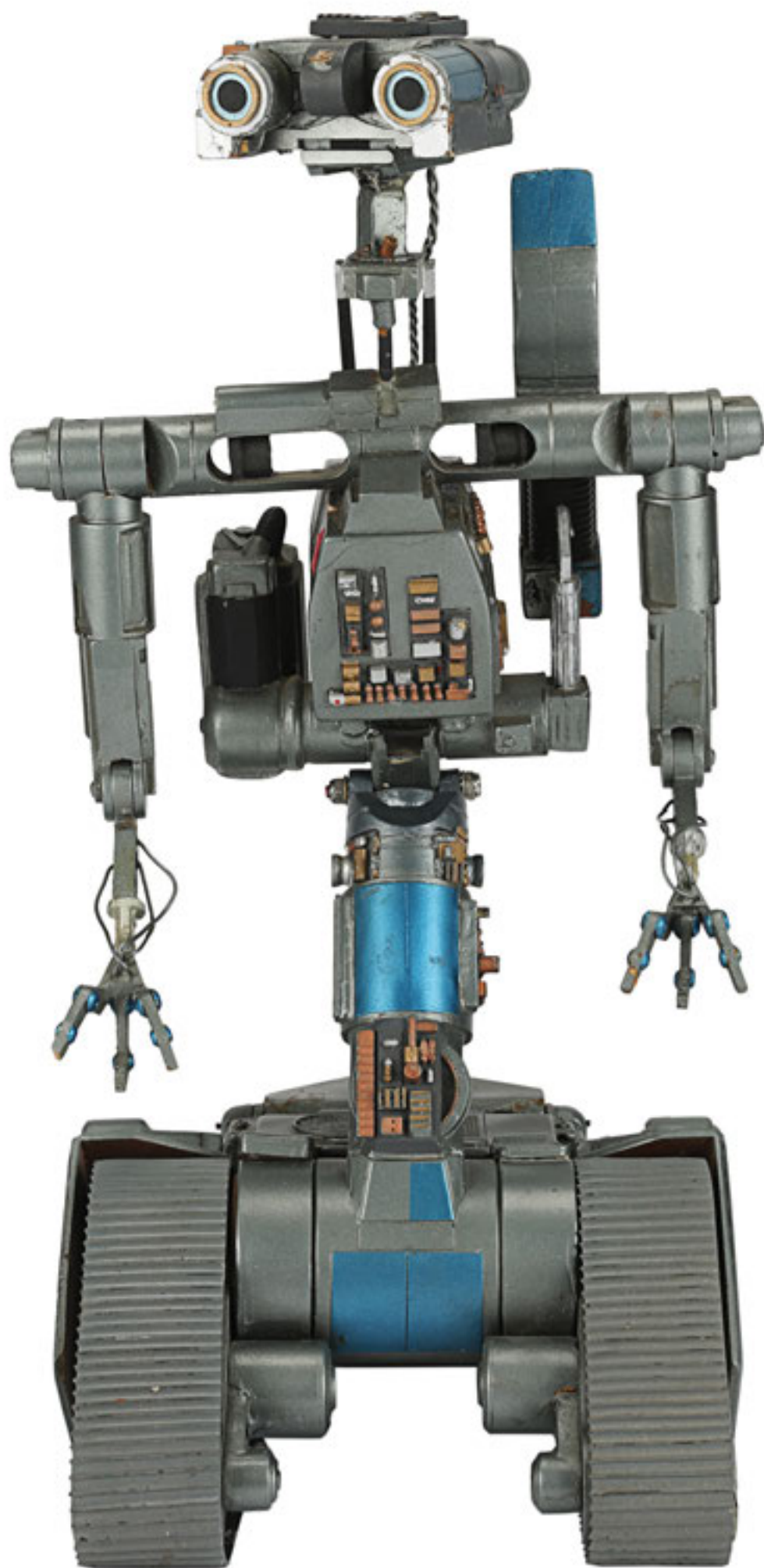

399. Kevin's (Elijah Wood) Severed Head and Glasses M

SIN CITY (2005)

Kevin's (Elijah Wood) severed head and glasses from the Frank Miller and Robert Rodriguez comic-book crime thriller *Sin City*. After Goldie (Jaime King) was murdered by psychopathic cannibal Kevin, Marv (Mickey Rourke) tracked him down and wreaked revenge by mutilating and beheading him.

Made of silicone, the head displays a great likeness to Wood's character, with hand-punched hair across the scalp and eyebrows, and hair also applied to the eyelids. The eyeballs are made of resin, featuring painted lines to appear bloodshot. The head is covered in stage-blood spatter, some of which has solidified and stuck to the hair above the neck.

The head is accompanied by a pair of glasses with a metal frame and flexible, curved arms. The glasses have been intentionally distressed, featuring stage blood and a broken lens. The head is displayed on a black base.

Dimensions (including base): 25.5 cm x 20 cm x 24.5 cm (10" x 7 ¾" x 9 ¾")

£4,000-6,000



400. Smurf Trap, Chair and Toy Cannon †Δ

THE SMURFS (2011)

A Smurf trap, chair and cannon from Raja Gosnell's fantasy-comedy *The Smurfs*. Smurf traps and a chair were part of Gargamel's (Hank Azaria) lair as he tormented Papa Smurf. The cannon was used by Gutsy in a New York toy store to outsmart Gargamel.

The Smurf trap consists of a wooden base with metal bars finished in shades of faux silver, producing a worn metal appearance. Made of wood, the chair features brown leather wrist straps, a metal foot rest and a cog piece attached to one side. The blue and yellow toy cannon is made of plastic and is accompanied by three foam bullets.

Dimensions (trap): 25 cm x 25 cm x 30 cm (10" x 10" x 12"); (chair): 11 cm x 11 cm x 14.5 cm (4 1/2" x 4 1/2" x 5 3/4"); (cannon): 48 cm x 29 cm x 25 cm (19" x 11 1/2" x 10")

£200-300



401. Gargamel's (Hank Azaria) Costume and Wand †Δ

THE SMURFS (2011)

Gargamel's (Hank Azaria) costume and wand from Raja Gosnell's fantasy-comedy *The Smurfs* (2011). The evil wizard wore his costume throughout the film and used his wand to transport himself and his cat Azrael to the Smurf village.

The costume consists of a tattered robe, red long johns and suede shoes with red lining. Made from black linen, the robe features decorative grey patches, with a label reading "#2 Gargamel" adhered to the inside.

Finished in brown to replicate the appearance of carved wood, the wand is constructed from dense rubber and features brown leather cord tied around the middle. The robe has been intentionally distressed for production use and the wand displays minor paint wear. Dimensions (wand): 36 cm x 3 cm x 8 cm (14 1/4" x 1 1/4" x 3 1/4")

£600-800



402. Main Cast-Autographed Production-Used Pilot Script M

THE SOPRANOS (TV SERIES 1999 - 2007)

An autographed production-used script from gangster-drama television series *The Sopranos*. Written by David Chase, this salmon revision script for the pilot episode is dated 25 August 1997 and contains 65 U.S. Letter pages, bound together with three brass split pins.

The unannotated script features a cover page displaying 11 main cast autographs, including James Gandolfini, Lorraine Bracco, Edie Falco and Michael Imperioli — in various black inks. Lightly used, the script shows very minor corner creases from production use. Dimensions: 28 cm x 22 cm x 1.5 cm (11" x 9" x 1/2")

£600-800



403. Dot Matrix's (Lorene Yarnell Jansson) Mask and Behind-the-Scenes Photo Album Ω

SPACEBALLS (1987)

Dot Matrix's (Lorene Yarnell Jansson) mask and a behind-the-scenes photo album from Mel Brooks' sci-fi parody *Spaceballs*. While playing the loyal droid, Jansson wore the mask throughout the film as Dot Matrix and Princess Vespa (Daphne Zuniga) were kidnapped by the evil Dark Helmet (Rick Moranis) and eventually rescued by Lone Starr (Bill Pullman) and his trusty sidekick Barf (John Candy).

Dot Matrix was named after a popular computer printer from the 1970s and was voiced by Joan Rivers. However, the droid was physically portrayed by Lorene Yarnell Jansson, one half of a mime duo coined 'Shields and Yarnell'. Six complete suits were built for the character of Dot Matrix, with each suit switched out as they became damaged on set.

The mask is made of vacuum-formed plastic and is detailed with geometric lines for the cheeks and the nose. Finished in faux gold, the interior of the mask features several pieces of metal mesh adhered to the openings for the eyes, nose and mouth.

The photo album is bound in blue leather with printed faux-gold patterns on the front cover and spine, and contains 65 colour photos and three Polaroid images showing various cast members on the set.

The mask displays signs of production use, including minor marks and scratches that have removed the faux-gold finish. Remnants of glue are visible on the inside of the mask and small pieces of tape residue are visible on its exterior. The album cover shows light scratches and the pages show minor wear and discoloration.

Dimensions (mask): 27 cm x 20 cm x 14 cm (10 3/4" x 8" x 5 1/2"); (album): 23.5 cm x 21 cm x 4 cm (9 1/4" x 8 1/4" x 1 3/4")

£8,000-10,000



404. USS Hannibal Spaceship Model Miniature US**SPACEHUNTER: ADVENTURES IN THE FORBIDDEN ZONE (1983)**

A USS Hannibal spaceship model miniature from Lamont Johnson's sci-fi film *Spacehunter: Adventures in the Forbidden Zone*. Space adventurer Wolff (Peter Strauss) flew in his salvage spaceship at the beginning of the film when he travelled to Terra XI to rescue three women who crashed on the plagued planet.

Made of surfboard foam, the wide-bodied futuristic spaceship features expansive wings and is outfitted with a poseable claw armature, decorative greeblies and numerous decals. The cockpit includes two miniature chairs and is visible through rounded clear-plastic windows. The spaceship was previously wired to light up and still includes original electronic components.

Paired with the model are five colour photographs showing it being constructed during pre-production. The model shows minor wear to the surfboard foam, which has cracked on the wings. However, the piece has undergone sympathetic restoration and remains in fine condition. Dimensions: 152.5 cm x 81 cm x 5 cm (60" x 32" x 20")

This item contains electronic components. While every effort has been made to describe them accurately, no guarantee or warranty is made as to the functionality, lifespan or safety of those components. It is entirely incumbent on the new owner to satisfy themselves as to their safe use and maintenance.

£2,000-3,000**405. Parker Family Photograph Ω****SPIDER-MAN (2002)**

A Parker family photograph from Sam Raimi's superhero film *Spider-Man*. Peter Parker (Tobey Maguire) kept a framed family photo next to Aunt May's (Rosemary Harris) hospital bed after she was attacked by the Green Goblin (Willem Dafoe).

This family photo is displayed inside a wooden frame and shows the Parker family before Uncle Ben's (Cliff Robertson) tragic death. It is sealed at the rear with a single piece of black gaffer tape. The frame contains no glass, in order to produce less glare and reflection during the filming process. Accompanying this lot is a certificate of authenticity from Columbia Pictures and a small note on Sony Pictures letterhead. This photo shows minimal signs of wear and is in very fine overall condition.

Dimensions (framed): 21.5 cm x 16.5 cm (8 ½" x 6 ½")

£1,500-2,000**406. Sam Raimi Autographed Director's Chairback M****SPIDER-MAN (2002)**

Sam Raimi's autographed director's chairback from the superhero adventure *Spider-Man*. Chairbacks were used throughout the production by cast and crew members, with this particular chairback designated for director Sam Raimi. Made of thick black canvas material, the chairback features "Sam Raimi" printed in red on the front, and the Spider-Man symbol in red on the back. Sam Raimi's autograph is written clearly in white ink on the front. The chairback is accompanied by a chair seat, also made of canvas, with two wooden rods on each side to secure it to the chair frame. The chairback and seat display light marks from use. Dimensions (chairback): 55.5 cm x 17.5 cm (21 ¾" x 6 ¾")

£300-500**407. Pair of Daily Bugle Newspaper Covers †Δ****SPIDER-MAN (2002)**

A pair of *Daily Bugle* newspaper covers from Sam Raimi's superhero adventure *Spider-Man*. *Daily Bugle* newspapers are seen throughout the film, with these issues found in the *Daily Bugle* office and in the home of Peter Parker (Tobey Maguire) after he became the official *Spider-Man* photographer for the tabloid newspaper.

Printed on newspaper stock, the *Daily Bugle* masthead runs across the top and the front-page headlines read "Reward! For photos of Spider-Man" and "Police Seek Spider-Man!", with the latter showing an image of Spider-Man above the streets of New York. The covers are dated "October 21st, 2001" and "Monday Late Edition" respectively. The inside and back covers are identical, displaying unrelated news content. Dimensions (each): 38.5 cm x 29 cm x 0.5 cm (15 ¼" x 11 ½" x ¼")

£300-500**408. Peter Parker's (Tobey Maguire) Hand-Drawn Spider-Man Costume Notebook Ω****SPIDER-MAN (2002)**

Peter Parker's (Tobey Maguire) hand-drawn *Spider-Man* costume notebook from Sam Raimi's superhero adventure *Spider-Man*. Peter drew a number of concepts for his *Spider-Man* costume upon discovering his new superpowers. This item is screen-matched to a close-up shot of Peter inking one of his sketches. The drawings are done by comic-book artist Phil Jimenez, whose hands were shot in close up for the shot.

The spiral notebook contains quad-ruled grid paper with hand-drawn illustrations of *Spider-Man* rendered in pen and marker. There are dozens of sketches, with seven pages featuring partially coloured-in drawings. Most depict *Spider-Man* in the same pose, with a few pages showing illustrations of his mask and his upper torso only. Some pages feature handwritten notes, which read, "NEED SYMBOL?", "UTILITY BELT?", "CAPE?", "GOGGLES" and "KEEP".

Accompanying the lot is a certificate of authenticity from Columbia Pictures. The notebook shows minor wear due to production use, but remains in very fine condition. Dimensions (closed): 28 cm x 22 cm x 1 cm (11" x 8 ¾" x ¼"); (open): 28 cm x 44 cm x 1 cm (11" x 17 ¼" x ¼")

Please note this lot is sold without copyright, reproduction rights, licensing agreements or any other type of legal release.

£3,000-5,000

409. Light-Up Fin Pistol †Δ

SPIDER-MAN: HOMECOMING (2017)

A light-up 'fin pistol' from Jon Watts' superhero film *Spider-Man: Homecoming*. The adapted alien weapons were created and distributed by Adrian Toomes' (Michael Keaton) gang, after his salvage company was driven out of business by Tony Stark (Robert Downey Jr.) and the US government.

Originally based on a replica ASG Steyr M9 pistol, the weapon is constructed from cast resin and designed to look like a fusion of human and alien technology. It features a conventional pistol grip, magazine and trigger, with various alien embellishments: a rock-like, alien barrel, finished in metallic blue paint; a chrome-

coloured casing in place of the pistol's slide; and a and a clear crystal (made of plastic) secured to the muzzle. Powered by a 9V battery inserted into the grip, a

small switch on the bottom of the magazine illuminates white lights on the stock casing; compressing the trigger also allows the muzzle to light up.

Accompanying the pistol is a Columbia Pictures certificate of authenticity. The weapon is designed to look distressed, with artificial corrosion decoration throughout. Dimensions: 31 cm x 6 cm x 16 cm (12 ¼" x 2 ½" x 6 ¼")

This item contains electrical components. While every effort is made to describe them accurately, no guarantee or warranty is made as to the functionality, lifespan or safety of those components. It is entirely incumbent on the new owner to satisfy themselves as to their safe use and maintenance.

£2,000-3,000

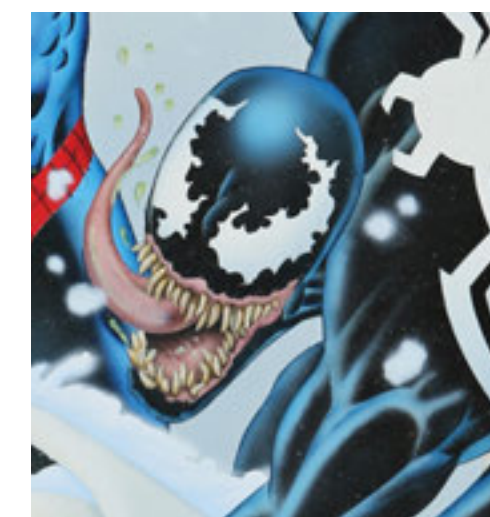

410. Mike Zeck and Phil Zimelman Hand-Painted Cover Artwork Ω

SPIDER-MAN SUPER THRILLER: MIDNIGHT JUSTICE (1996)

Hand-painted cover artwork by Mike Zeck and Phil Zimelman featuring Spider-Man and Venom facing off for the *Spider-Man Super Thriller: Midnight Justice* novel by Martin Delrio. The book cover artwork shows Spider-Man punching Venom off a snow-covered city bus, with the Human Torch flying in from above.

Notably, in 1984, penciller Mike Zeck designed the Black Costume Spider-Man, which later evolved to become the symbiote known as Venom. This is one of the few times Zeck drew Venom for publication.

This original full-colour cover artwork was pencilled by Mike Zeck and painted by Phil Zimelman on illustration paper secured to foamcore board. At the bottom right

are Zeck and Zimelman's signatures. Included with the lot is a reference copy of the novel in which this art was originally published. The board shows paint splotches on the taped border, but the artwork remains in very fine condition.

Dimensions: 53 cm x 36 cm x 1 cm (20 ¾" x 14 ¼" x ¼")

Please note this lot is sold without copyright, reproduction rights, licencing agreements or any other type of legal release.

£2,500-3,000

411. Steve Ditko Hand-Drawn Page 15 2/3 Splash Page Artwork Ω

THE AMAZING SPIDER-MAN #32 (1966)

Hand-drawn 2/3 splash page artwork by Steve Ditko used to produce page 15 of *The Amazing Spider-Man #32*, with Spider-Man facing off against Doctor Octopus. This issue was plotted, pencilled and inked by Spider-Man co-creator Steve Ditko, and follows Spidey as he tracks down radioactive-material thief, the Master Planner, who turns out to be Doctor Octopus.

Included with the lot is a reference copy of *The Amazing Spider-Man #32*, the comic book in which this art was originally published. White-out correction fluid is present, and the back of the artwork shows tape residue. The artwork remains in very good condition.

Dimensions: 51.5 cm x 34 cm (20 1/4" x 13 1/2")

Please note this lot is sold without copyright, reproduction rights, licencing agreements or any other type of legal release.

£95,000-110,000

Ditko-drawn Spider-Man pages featuring the hero fighting his key villains are some of the most desirable pieces in comic-art collecting. Action splashes or semi-splashes like this are rarely offered.

This original pencilled-and-inked artwork is drawn on Bristol board and features three panels. The top two panels show Spidey crawling on the ceiling, with the bottom panel showing Doc Ock attacking Spider-Man with his mechanical tentacles.



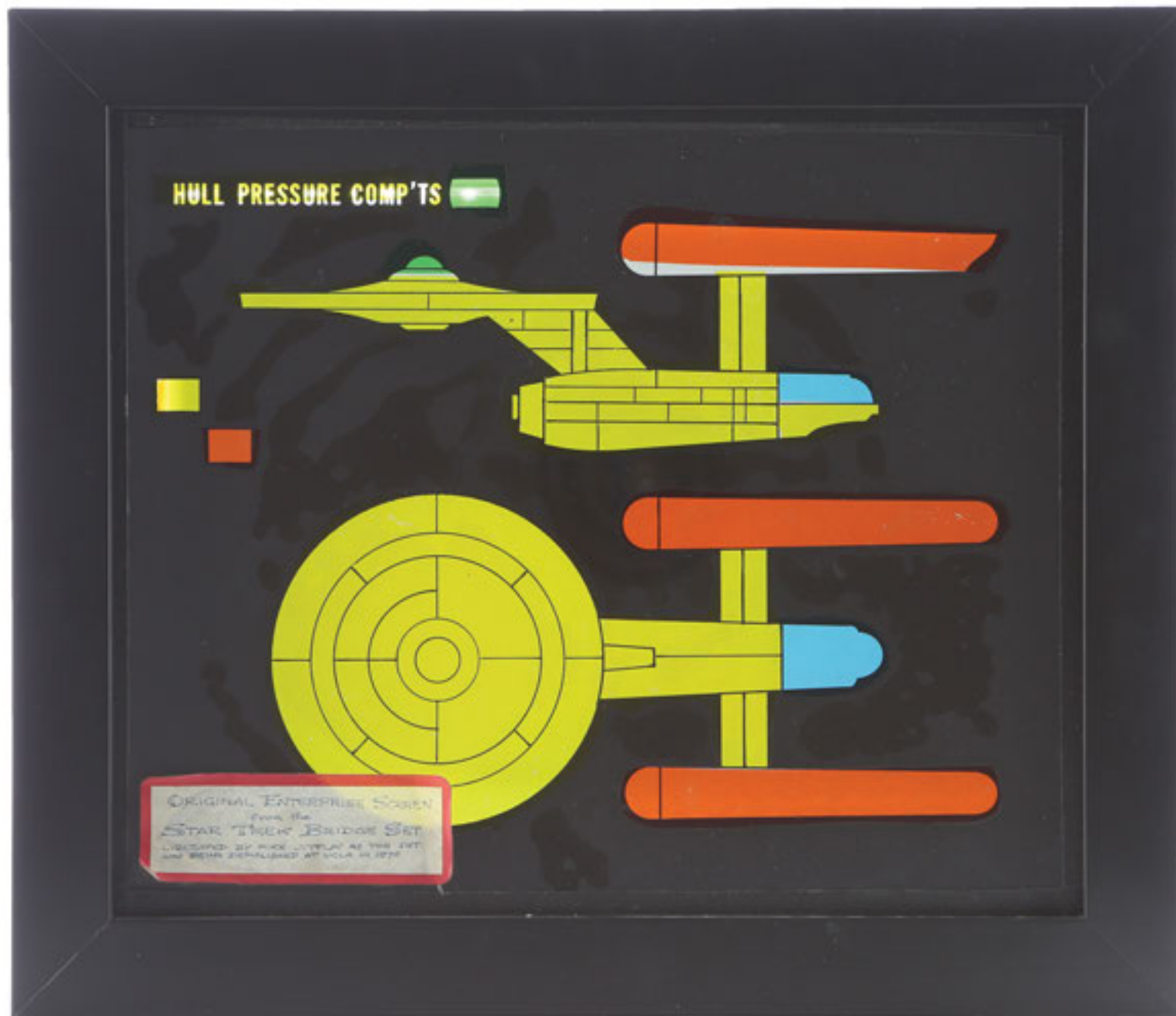

412. USS Enterprise Bridge Translite Ω

STAR TREK (TV SERIES, 1966 - 1969)

A USS Enterprise bridge translite from Gene Roddenberry's original television series *Star Trek*. This screen served as set decoration on the USS Enterprise bridge throughout the pilot episode, as well as all three seasons of the sci-fi show. Visible on consoles to the left of the captain's chair, this translite was rescued by animator Mike Jittlov while the original bridge set was being demolished at University of California, Los Angeles.

This translite was made by producing colourful gels in the shape of the USS Enterprise. The gels were then sandwiched between two panels of glass and placed in front of a light box to achieve the desired 'screen' effect. A label is placed at the bottom right corner and reads, "Original Enterprise Screen from the *Star Trek* Bridge Set Liberated by Mike Jittlov as the set was being demolished at UCLA in 1970".

The piece has been placed inside a custom display that reproduces its original light-box effect using bright LEDs. Gaffer tape, used to hold the two glass panels together, is visible around the border. Additionally, a handwritten letter from Mike Jittlov is included with this lot. The screen shows minimal signs of wear and is in very fine overall condition.

Dimensions: 35.5 cm x 6 cm x 30.5 cm (14" x 2 1/4" x 12")

This display contains electronic components. While every effort is made to describe them accurately, no guarantee or warranty is made as to the functionality, lifespan or safety of those components. It is entirely incumbent on the new owner to satisfy themselves as to their safe use and maintenance.

£8,000-10,000

413. Type 2 Phaser Ω

STAR TREK: THE NEXT GENERATION (TV SERIES, 1987 - 1994)

A type 2 phaser from Gene Roddenberry's sci-fi series *Star Trek: The Next Generation*. Type 2 phasers varied throughout the series, with this version debuting on the show in the third season.

Made of resin, the hand-held phaser features a slight curve and is painted silver and black with a ribbed grip. The phaser includes three static buttons: one for controlling the beam range, one for beam intensity, and one to fire the weapon. The prop phaser features three green stickers to represent power-level indicator screens. The piece shows wear due to production use, with the green stickers peeling away from the surface and light paint flaking.

Dimensions: 21 cm x 6 cm x 4.5 cm (8 1/4" x 2 1/4" x 1 3/4")

£3,000-5,000



414. Tasha Yar's (Denise Crosby) Uniform †Δ

STAR TREK: THE NEXT GENERATION (TV SERIES 1987 - 1994)

Tasha Yar's (Denise Crosby) uniform from *Star Trek: The Next Generation*. The human Starfleet officer wore her uniform in one scene towards the end of the pilot episode "Encounter at Farpoint". This scene was the only time Tasha wore this style of uniform.

Originally obtained from the production's costume designer William Ware Theiss, the skant uniform is made from black spandex with incorporated mustard-coloured panels and matching piping. Two hook-and-eye fastenings adorn the front, and the bottom of the garment features a built-in gusset. A resin Starfleet communicator badge finished in faux gold and grey is adhered via Velcro to the left side of the chest. Attached to the inside neckline is a white cotton strip of tape with the text "D.Crosby #1" written in black. Displaying minor signs of wear, the uniform is accompanied by a letter of authenticity from John A. Castillo, a crew member who worked on the episode "The Arsenal of Freedom".

£4,000-6,000



415. Widely Utilized 'Husnock' Starship Model Miniature Ω

STAR TREK: THE NEXT GENERATION (TV SERIES, 1987 - 1994); STAR TREK: DEEP SPACE NINE (TV SERIES, 1993 - 1999); STAR TREK: VOYAGER (TV SERIES, 1995 - 2001); STAR TREK: ENTERPRISE (TV SERIES, 2001 - 2005)

A model miniature spaceship from the sci-fi television series *Star Trek: The Next Generation*, *Star Trek: Deep Space Nine*, *Star Trek: Voyager* and *Star Trek: Enterprise*. Appearing in more than 20 episodes, the ship was originally created as the Husnock ship for The Next Generation episode "The Survivors", and was modified by model makers throughout the years to appear as various other ships. Although its last appearance as a model miniature was in the *Star Trek: Deep Space Nine* episode "Take Me Out to the Holosuite", its on-screen life continued as a CG model until the *Star Trek: Enterprise* episode "The Breach", where it appeared as a Xanatoras evacuation ship. Other noteworthy episodes the model appeared in were "The Most Toys", "Half a Life", "Silicone Avatar" and "Unification 1" in *Star Trek: The Next Generation*; "A Man Alone", "Shadowplay", "Rules of Engagement" and "Take Me Out to the Holosuite" in *Star Trek: Deep Space Nine*; and "Ex Post Facto" and "Warlord" in *Star Trek: Voyager*.

The triangular ship is made of fibreglass with an internal metal armature, and is decorated with an array of styrene greeblie detailing throughout the hull. Painted blue-grey, the ship is outfitted with dozens of small lights that run along the hull,

and includes three red engine panels that were illuminated internally. A removable panel below the bridge provides access to the electronic cabling which runs through the interior and exits through a hole cut into the bottom of the model.

The miniature includes a production storage crate which features the names of other vessels it has been modified to appear as, including "Bajoran" and "Jovis". The model is believed to have represented more different craft than any other in Trek history, and as such is well-used in the Star Trek saga, exhibiting minor cracks and wear to the paint finish. However, it remains in very fine condition. Dimensions (ship): 66 cm x 35.5 cm x 18 cm (26" x 14" x 7"); (crate): 91.5 cm x 66 cm x 49.5 cm (36" x 26" x 19 1/2")

This item contains electronic components. While every effort has been made to describe them accurately, no guarantee or warranty is made as to the functionality, lifespan or safety of those components. It is entirely incumbent on the new owner to satisfy themselves as to their safe use and maintenance.

£20,000-30,000





416. Captain Picard's (Patrick Stewart) Starfleet Uniform †

STAR TREK: THE NEXT GENERATION (TV SERIES 1987 - 1994)

Captain Jean-Luc Picard's (Patrick Stewart) Starfleet uniform from *Star Trek: The Next Generation*. Picard wore his one-piece uniform throughout the first two seasons as he and his crew set out on their mission to boldly go where no one had gone before. An "improved" two-piece uniform was introduced for the third season of this classic television show, which then had all the main characters pulling down at their jackets in countless scenes.

The one-piece burgundy-and-black Starfleet uniform is made from spandex, with a hidden zip from the collar to the waist and zips at the ankles for a tight fit. Four brass captain rank pips are at the right side of the collar and a replica Starfleet communicator badge is found on the left side of the chest. A costumiers' label inside has handwritten detail reading, "#2 Patrick O22". With only minor signs of wear, the costume remains in excellent condition and is presented on a custom-made display stand.

Dimensions (displayed): 173 x 62 x 37 cm (14.5" x 24" x 68")

£10,000-£15,000



417. Seven of Nine's (Jeri Ryan) Borg Exo-Glove †Δ

STAR TREK: VOYAGER (TV 1995 - 2001)

Seven of Nine's (Jeri Ryan) Borg exo-glove from *Star Trek: Voyager*. Seven of Nine retained some of her robotic appearance after her de-Borgification in the fourth season. The piece is attributed to the sixth season finale episode "Unimatrix Zero", in which Seven of Nine makes contact with a secretive Borg enclave in a virtual reality world.

Made from foam rubber, the glove is finished in metallic steel and brass-effect paint. There is wear to the glove and some sections have become detached. However, it remains in good but fragile condition, and is presented on a black flocked hand. Also included is a studio certificate of authenticity and an autographed 10" x 8" promotional still of the character, signed in gold ink. Dimensions (hand display): 32 cm x 15 cm x 4 cm (12 1/2" x 6" x 1 1/2")

£2,000-3,000

418. Seven of Nine's (Jeri Ryan) Starfleet Uniform Ω

STAR TREK: VOYAGER (TV SERIES, 1995 - 2001)

Seven of Nine's (Jeri Ryan) Starfleet uniform from the sci-fi television series *Star Trek: Voyager*. After she was liberated from the Borg, Seven was allowed to stay on board the USS Voyager. While she initially wore a Borg-like silver suit, Seven's outfit changed to a purple color as she adjusted back to human life.

This one-piece suit is made from purple tinsel lurex fabric. The elastic qualities of the fabric enabled Seven's outfit to have its signature tight fit. A hidden zipper closes the suit at the back and clasps complete the seamless look at the collar. Additionally, the feet close at the rear with Velcro, in order to allow an easier fitting.

A Starfleet badge is also included and attaches to the suit with Velcro. The badge is made of resin and has the number 10 written on its reverse side. The piece shows minimal signs of wear and is in very fine condition.

£4,000-6,000





419. Tom Sutton and Ricardo Villagran Hand-Drawn Cover Artwork Ω

STAR TREK #20 (1985)

Hand-drawn cover artwork by Tom Sutton and Ricardo Villagran featuring Sulu, from *Star Trek #20*. In this issue, which is titled "Giri" (Japanese for honour), Commander Sulu found excitement and danger as he took shore leave for a wedding.

This original pencilled-and-inked artwork is drawn on Bristol board by penciller Tom Sutton and inker Ricardo Villagran. The cover shows Sulu using a sword to defend himself against Reijiro, the groom, who operates a cyber suit. This was the first cover to feature Sulu alone, and shows the Starfleet officer using a sword — although he does not wield one in the comic. Pasted onto the artwork are the artist's names, issue block, title art, barcode block and tagline, which reads: "SULU GOES HOME -- TO LEARN THE MEANING OF HONOR!" On the back of the sheet is a DC Comics stamp and a handwritten date, "5/8/85".

Included with the lot is a reference copy of *Star Trek #20*, the comic book in which this art was originally published. The artwork shows three staples, minor paper discolouring and tape residue, but remains in fine condition.

Dimensions: 29 cm x 43 cm (11 1/2" x 17")

Please note this lot is sold without copyright, reproduction rights, licencing agreements or any other type of legal release.

£500-800



420. Production-Made Stunt S-5 Naboo Blaster †Δ

STAR WARS: THE PHANTOM MENACE (1999)

A production-made stunt S-5 Naboo blaster from *Star Wars: The Phantom Menace*. Queen Amidala's (Natalie Portman) security guards used their blasters during the Battle of Naboo as they reclaimed Theed Palace from the Trade Federation.

Used for scenes in which close-up shots were not required, the main body of the blaster is cast from dense rubber with an internal metal armature and features a faux-scope. Embedded factory markings adorn both sides and the it is finished in black and faux-silver paint. The blaster displays signs of production use, including minor marks and paint wear, notably on the parts finished in faux-silver.

Dimensions: 37 cm x 4 cm x 19 cm (14 3/4" x 1 3/4" x 7 1/2")

£2,000-3,000



421. Naboo Security Guard's CR-2 Blaster M

STAR WARS: THE PHANTOM MENACE (1999)

A Naboo Security Guard's CR-2 blaster from *Star Wars: The Phantom Menace*. Queen Amidala's (Natalie Portman) security guards used their blasters during the Battle of Naboo, as they retook Theed Palace from the occupying Trade Federation forces.

Based on the design of a Calico M961A carbine, the blaster is cast in dense foam with additional components, including a resin faux-scope, grip attachment and metal barrel. The body of the weapon is cast from a Calico submachine gun, with embedded original factory markings on both sides, and is finished in black and faux-silver paint, creating a futuristic appearance. The weapon displays light wear to the paint finish, minor scratches and an orange paint scuff from use during production.

Dimensions: 44 cm x 9cm x 25 cm (17 1/4" x 3 1/2" x 10")

£2,000-3,000





422. Qui-Gon Jinn's (Liam Neeson) Lightsaber †Δ

STAR WARS: THE PHANTOM MENACE (1999)

Qui-Gon Jinn's (Liam Neeson) lightsaber from George Lucas' *Star Wars: The Phantom Menace*. The Jedi Master wielded his lightsaber as he battled against the Trade Federation's droids and duelled with Sith apprentice Darth Maul (Ray Park) on Tatooine and at Naboo's Theed Palace. Qui-Gon's lightsaber was subsequently used by Obi-Wan Kenobi (Ewan McGregor) to avenge his master.

In the *Star Wars* canon, Qui-Gon Jinn built his lightsaber to imitate the weapon of his then-master, Dooku (Christopher Lee), who would fall to the dark side of the Force and become a Sith apprentice. Thousands of variations of lightsabers were created for *The Phantom Menace* by design director Doug Chiang, with each Jedi having a uniquely crafted lightsaber designed to reflect their personality. Liam Neeson personally picked this hilt design for his character.

Made of resin, the lightsaber hilt features ribbed detailing running from the blade emitter down to the base — which acts as a grip — and a round blade projection plate at the top. A round activator switch protrudes from one side and displays remnants of red metallic paint. The hilt is finished in a combination of black and metallic faux-silver paint. The lightsaber displays paint wear from production use, notably on the activator switch, while bubble marks from the casting process are still present. The piece has been sympathetically restored following damage received during production. Please contact Prop Store for further details regarding the lightsaber's restoration process.

Dimensions: 28.5 cm x 4.5 cm x 5 cm (11 1/4" x 1 3/4" x 2")

£10,000-15,000



423. Ray Park Autographed Lightsaber Blade M

STAR WARS: THE PHANTOM MENACE (1999)

A Ray Park autographed lightsaber blade from George Lucas' *Star Wars: The Phantom Menace*. The construction of lightsaber blades evolved throughout the production of the *Star Wars* prequels, changing from aluminium to carbon fibre for *Revenge of the Sith*. Hundreds of blades were discarded as they either broke or became bent during battle scenes. The green colour suggests this blade may be attributed to Qui-Gon Jinn (Liam Neeson) or Obi-Wan Kenobi (Ewan McGregor).

The blade consists of an aluminium tube covered in luminous green paint, which has been shrink-wrapped for protection. One end is open, with four bolt fastenings allowing for the lightsaber hilt's threaded rod to be inserted and secured. It is autographed in blue marker by Ray Park, who played Darth Maul in *The Phantom Menace*. The autograph was obtained at a convention. The blade shows damage to the shrink-wrap layer and some minor scratches, and is in a broken state as a result of production use.

Dimensions: 53 cm x 3 cm x 2.5 cm (21" x 1 1/4" x 1")

£1,000-1,500

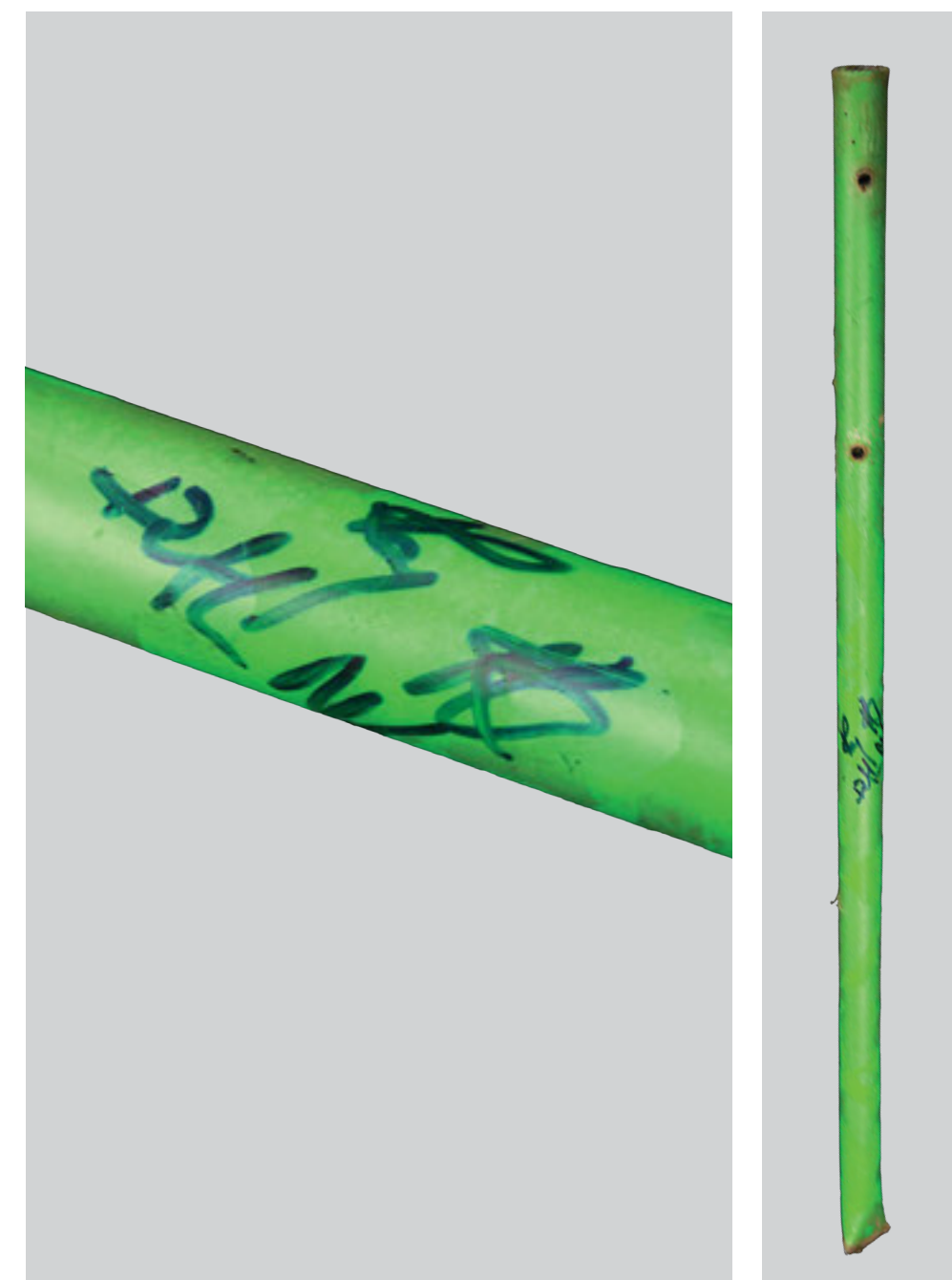

424. Darth Maul's (Ray Park) Final Battle Stunt Lightsaber Hilt M

STAR WARS: THE PHANTOM MENACE (1999)

Darth Maul's (Ray Park) lightsaber hilt from *Star Wars: The Phantom Menace*. This version of the lightsaber was created specifically for stunt purposes during the final battle sequence in Theed Palace, in which the Sith Apprentice fought Qui-Gon Jinn (Liam Neeson) and Obi-Wan Kenobi (Ewan McGregor).

Renowned stunt coordinator Nick Gillard, who worked on the *Star Wars* prequel trilogy, designed this hilt for a specific manoeuvre in the battle scene, in which Darth Maul jumped up and pivoted while a lightsaber blade swiped beneath him. In order for Park to safely hold the lightsaber and perform the move, the hilt needed extra support, so was attached to a metal rig for filming. Due to the fast-paced movements in the battle, it is unclear whether this particular sequence made the final cut of the film.

The double-ended hilt is cast in resin with a metal internal core adding weight. Finished in faux-silver paint, alternating control lock buttons and red activator buttons run down the length of the piece. Shades of dark grey have been used to give additional depth to detailing throughout, including the two ribbed handgrips and parts of the blade emitter plates. Both ends are open, exposing the internal metal rod where the metal rig would have been fastened. The hilt displays paint wear from use on production, exposing the resin beneath — notably on some of the buttons — and the lot shows minor marks and scuffs.

Dimensions: 47 cm x 5 cm x 5 cm (18 ½" x 2" x 2")

£10,000-15,000



425. Cast-and-Crew Autographed Alderaan Star Map M

STAR WARS: ATTACK OF THE CLONES (2002)

A cast-and-crew autographed Alderaan star map from George Lucas' *Star Wars: Attack of the Clones*. Obtained from MediCinema, this piece features autographs acquired on set during production by Jerome Blake, who played Oppo Rancisis in the film.

The laminated map shows the poster artwork used for the film with a star map printed over the top. It has been autographed in silver and gold-coloured marker by Ewan McGregor, Natalie Portman, Hayden Christensen, Christopher Lee, Samuel L. Jackson, Ian McDiarmid, Kenny Baker, Anthony Daniels, Jerome Blake and director George Lucas, with one unidentified signature. The lot shows surface scratches and minor wear at the edges, with black remnants on the back from when the piece had originally been framed.

Dimensions: 3 cm x 105.5 cm x 105.5 cm
(1 ¼" x 41 ¾" x 41 ¾")

£800-1,200



426. Interchangeable Lightsaber Blade †Δ

STAR WARS: REVENGE OF THE SITH (2005)

An interchangeable lightsaber blade from George Lucas' *Star Wars: Revenge of the Sith*. Interchangeable blades were used for stunts and fighting scenes, allowing the blade to be easily replaced in the event of damage or excessive production wear.

The materials used for the construction of lightsaber blades progressed throughout the production of the prequels. Aluminium was used to make the blades for *The Phantom Menace*, but this caused problems for the actors and stunt performers as the blades became bent and damaged. Ultimately, carbon fibre was used for *Revenge of the Sith*, proving hardy enough to withstand the rigors of the film's elaborate stuntwork. As a result, these blades were hardly replaced during filming.

The tube-like carbon fibre piece displays a luminous green finish with a shrink-wrapped outer layer for protection and both ends of the blade remain open. The blade shows light marks and wear to both ends from production use.

Dimensions: 94.5 cm x 1.5 cm x 1.5 cm (37" x ¾" x ¾")

£1,000-1,500

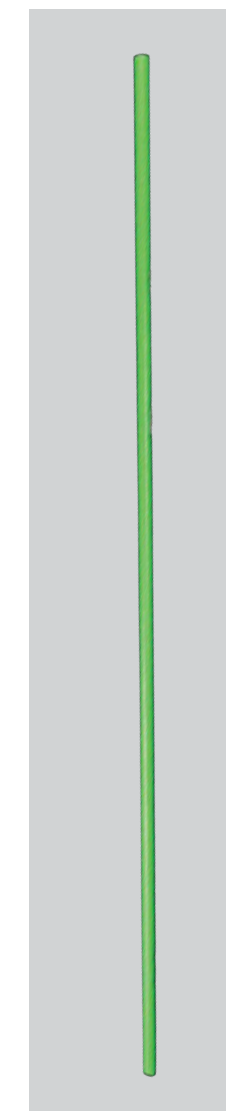



The following two lots come from prequels stunt coordinator/swordmaster Nick Gillard.

Nick's incredible talents have landed him some prestigious credits as a stunt performer, coordinator and second unit director.

As well as the three *Star Wars* prequels, his work includes *Aliens*, *Indiana Jones and the Last Crusade*, *Waterworld*, *Judge Dredd*, *Labyrinth*, *Empire of the Sun*, *Sleepy Hollow* and *Robin Hood: Prince of Thieves*.

427. Darth Sidious' (Ian McDiarmid) Hero Lightsaber M

STAR WARS: REVENGE OF THE SITH (2005)

Darth Sidious' (Ian McDiarmid) hero lightsaber from George Lucas' *Star Wars: Revenge of the Sith*. Hidden in plain sight as a mild-mannered Galactic Republic politician, Senator Palpatine was secretly a Sith lord, going by the name Darth Sidious. Sidious finally revealed himself to the Jedi in a lightsaber duel with Mace Windu (Samuel L. Jackson) and his Jedi cohort. Disarmed in the duel, it fell to Anakin Skywalker (Hayden Chistensen) to dispatch Windu, finally accepting Sidious as his new master. Sidious would wield a saber in battle once more against Master Yoda in the empty Galactic Senate chamber after the Republic's dissolution and the founding the Galactic Empire, ultimately defeating the Jedi Master and taking supreme control of the galaxy.

Shedding the more spartan design elements of traditional Jedi sabers, the Sith Lord opted for a more lavish weapon, something in keeping with his ostentatious character, limitless ambition and defiant machinations to overthrow the Republic and the Jedi. Sidious' saber is an elegant work of art in its own right.

This lightsaber is a hero, close-up version. Crafted in resin and vacuum metalized in a mirror chrome finish in silver and gold, the weapon features an ergonomic grip with a surround fitted with non-functioning red and green LEDs. The surround has a gunmetal finish, designed to refract light such that it would appear green or brown from differing angles during filming, adding to the unique appearance of the weapon. The emitter at the end of the grip is fashioned from brass.

This incredible artifact was gifted by the film's producers to noted stunt coordinator and sword master Nick Gillard as a thank you, on completion of the prequel trilogy. A letter from Nick accompanies the lightsaber.

Dimensions: 19 cm x 4 cm x 4 cm (7 1/2" x 1 1/2" x 1 1/2")

£50,000-£100,000

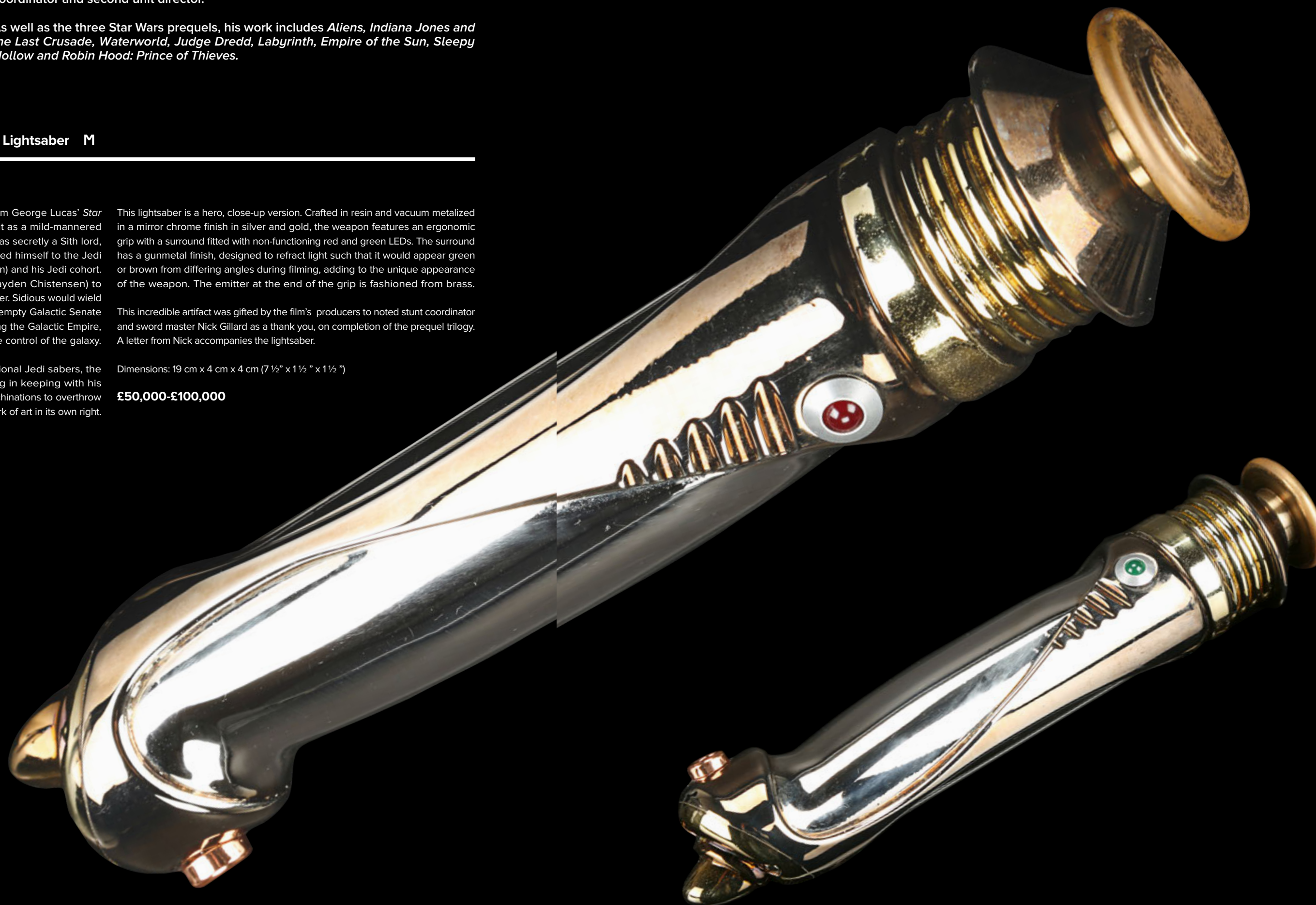

428. Anakin Skywalker's (Hayden Christensen) Hero Lightsaber M

STAR WARS: REVENGE OF THE SITH (2005)

Anakin Skywalker's (Hayden Christensen) hero lightsaber from George Lucas' *Star Wars: Revenge of the Sith*. Anakin used and wore his saber in various scenes throughout the saga, his weapon of choice in countless duels and battles, especially during the Clone Wars. Following his dramatic turn to the dark side of the Force and the purging of the Jedi Temple on Coruscant, the laser sword was ultimately lost in his duel with Obi-Wan Kenobi (Ewan McGregor) on the fiery planet of Mustafar.

Anakin's lightsaber, the legendary weapon of a Jedi Knight, is a significant prop in the *Star Wars* narrative. It is the same character saber that an aging Obi-Wan Kenobi (Alec Guinness) hands to Luke Skywalker (Mark Hamill) in *Star Wars: A New Hope*. The Jedi Master explains that it was his father's saber and his father wanted him to have it when he was old enough. "He feared you might follow old Obi-Wan on some damn fool idealistic crusade". Anakin's saber would be lost along with Luke's hand in *The Empire Strikes Back*, only to miraculously enter the possession of Rey (Daisy Ridley) in *The Force Awakens*. Driven by desire for his grandfather's saber, Kylo Ren (Adam Driver) would battle Rey for it in the throne room of Grand Leader Snoke (Andy Serkis) in *The Last Jedi*, resulting in its final destruction.

This lightsaber is a hero, close-up version. It was custom-made for *Revenge of the Sith* as a copy of the original Graflex-style saber used by Mark Hamill in the original trilogy, with incredible attention paid to the weapon's fine detail to ensure the utmost accuracy. The design is very slight smaller than that first saber, an intentional design change to allow the weapon to be easier to handle and fight with. It is constructed from resin which has been vacuum-metalized to a mirror chrome finish. Constructed to allow it to be worn on Anakin Skywalker's belt, it features a Coverttech belt clip, which is situated at the base of the handle. There is some minor cracking to the chrome. Black rubber strips to the handle complete the look of this legendary science fiction weapon.

This incredible artifact was gifted by the film's producers to noted stunt coordinator and sword master Nick Gillard as a thank you, on completion of the prequel trilogy. A letter from Nick accompanies the lightsaber.

Dimensions: 28 cm x 7 cm x 5.5 cm (11 x 2 ¾ x 2 ¼")

£50,000-£100,000



429. UK Pre-Oscar® Quad Poster †Δ

STAR WARS: A NEW HOPE (1977)

A UK quad poster (unrestored and folded F condition) from George Lucas' *Star Wars: A New Hope*. Designed by artist Tom Chantrell, the rare Style C poster was used to promote the film for a short time following its premiere and before the announcement of the 1978 Oscar® nominations. There are minor creases and edgewear throughout, with small pieces of tape and pinholes in each corner, and a tear on the top right fold line.

Dimensions: 76 cm x 101.5 cm (30" x 40")

£700-900



430. Ralph McQuarrie Autographed Jawa Sandcrawler Print M

STAR WARS: A NEW HOPE (1977)

An autographed print of Ralph McQuarrie's original artwork for George Lucas' *Star Wars: A New Hope*. The originals were created with a combination of opaque gouache and acrylic on illustration board mounted on hardboard, with this print recreated for a special portfolio released at the time of filming *The Empire Strikes Back*. The print depicts the Jawa sandcrawler at night, with the two droids C-3PO and R2-D2 escaping, as well as two paragraphs detailing the creation of the image and McQuarrie's autograph below the image in black ink.

Dimensions: 36 cm x 27 cm (14" x 10 1/2")

£300-500



431. Stuart Freeborn and Kay Freeborn Autographed Photographs †Δ

STAR WARS: A NEW HOPE (1977)

A set of four autographed photos from George Lucas' *Star Wars: A New Hope*. Printed on photographic paper, each image shows various characters — including Chewbacca (Peter Mayhew), Grand Moff Tarkin (Peter Cushing) and a group of Mos Eisley aliens — having prosthetics and make-up applied on set. The photos are all autographed by make-up artist Kay Freeborn and renowned make-up supervisor Stuart Freeborn in black, blue and silver-coloured marker pen. The set displays very minor surface scratches and a minor crease line, while one of the photos displays a light glue residue mark.

Dimensions (larger photos): 28 cm x 23 cm (11" x 9")

£200-300



432. Lot Removed

Lot Removed.

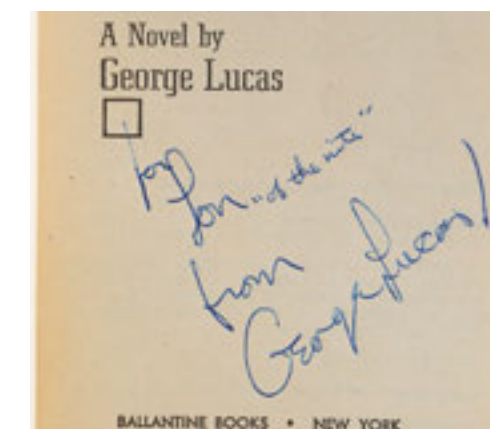
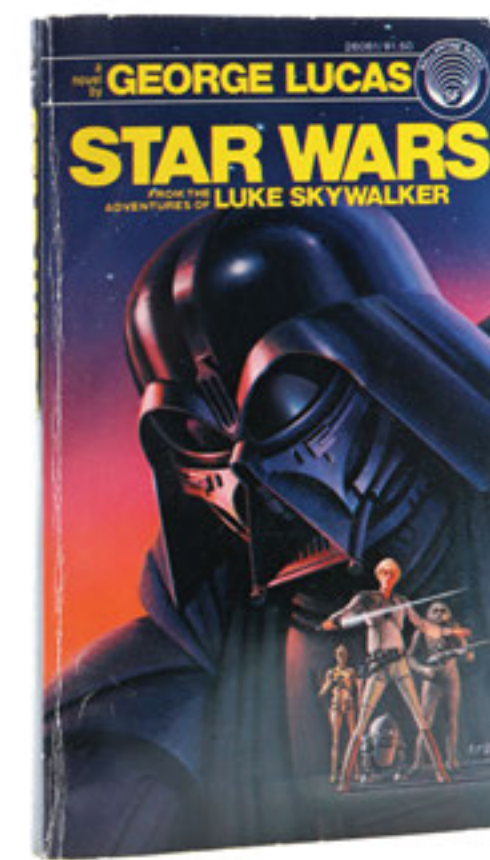

433. George Lucas Autographed First-Edition Novel Ω

STAR WARS: A NEW HOPE (1977)

An autographed first edition of George Lucas' 1976 novel *Star Wars: From the Adventures of Luke Skywalker*. Released in November 1976, the novel was one of the earliest *Star Wars* collectibles issued prior to the film's release.

The cover features artwork by Ralph McQuarrie and the title page includes Lucas' full signature with a note that reads, "For Lon of the night", as it was signed for Lon Tinney who worked night shifts at Industrial Light & Magic. The book shows some wear to the cover, but remains in very fine condition.

Dimensions: 18 cm x 11 cm x 2 cm (7" x 4 1/4" x 3/4")

£2,000-3,000

434. Autographed Fourth-Draft Script Ω

STAR WARS: A NEW HOPE (1977)

An autographed fourth-draft script for George Lucas' *Star Wars: A New Hope*. Dated 1 January 1976, this 145-page script bears the original title "The Adventures of Luke Starkiller, as taken from the 'Journal of the Whills'".

Bound in a three-ring binder, the fourth-draft script features a blue card cover with a large triangular sticker showing Ralph McQuarrie's original logo for "The *Star Wars*". The front cover includes a yellow printed label for visual effects artist Lon Tinney. This early script offers remarkable insight into the creation of the beloved first *Star Wars* film, and includes early character names and locations which would be omitted or changed by the time of filming.

The cover and title page were signed by many crew members during a 20th anniversary reunion of Industrial Light & Magic staff, including Barbara Nelson,

Chris Casady, David McCue, David Robman, Doug Smith, James Shourt, Jerry Greenwood, Jim Nelson, Joe Johnston, Jonathan Seay, Kim Falkenburg, Paul Roth, Richard Edlund, Stuart Ziff, and many others. This script displays minor wear, but remains in good condition.

Dimensions: 30 cm x 26 cm x 4 cm (11 ¾" x 10 ¼" x 1 ½")

Please note this lot is sold without copyright, reproduction rights, licensing agreements or any other type of legal release.

£6,000-8,000

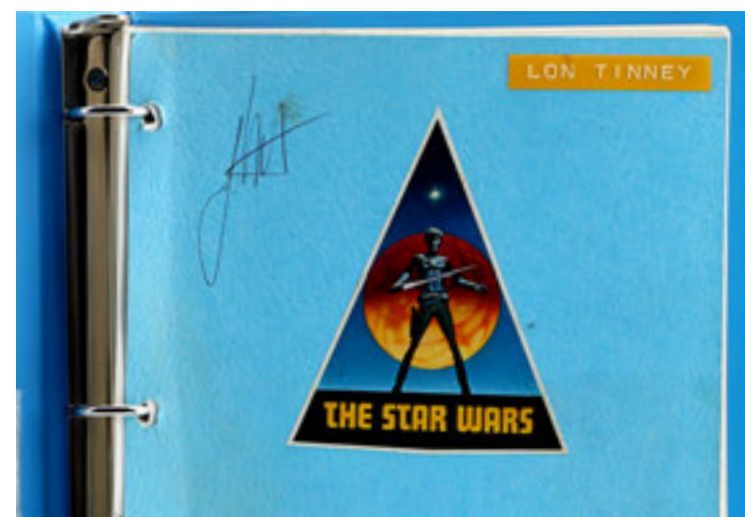

435. Film Can M

STAR WARS: A NEW HOPE (1977)

A film can used for cinema screenings of George Lucas' *Star Wars: A New Hope*. The film can lid displays a waxed Technicolor label, which features the print number "DOL 109" written in black marker. A strip of bright yellow tape has been applied to the outside of the piece and displays the text "-sf 35.04 - Reel Two of Six" written in green. The lot shows indentations around the outside from use and minor corrosion features all over.

Dimensions: 37.5 cm x 37.5 cm x 4 cm (14 ¾" x 14 ¾" x 1 ¾")

£600-800



436. Production Binder with Reports and Storyboards Ω

STAR WARS: A NEW HOPE (1977)

A production binder with reports and storyboards used for George Lucas' *Star Wars: A New Hope*. These early production documents contain information about the special-effects work on the film, including budget, storyboards and purchase records. Used early in production, these documents display the original address of Industrial Light & Magic at Van Nuys, California.

This set of documents contains over 50 pages of production information. Daily production expense reports are included in this set, providing a breakdown of the budget for special-effects elements. A set of ten early storyboard copies is also included. These storyboards were drawn by Joe Johnston and are some of the earliest boards produced for the film. Each shows scenes from the interior of the Millennium Falcon's cockpit. The binder shows slight signs of wear from use and storage, and is in very fine overall condition. Dimensions: 29 cm x 26 cm x 4 cm (11 ½" x 10" x 1 ½")

£1,000-1,500



437. ILM Production Documents and Rolodex Cards Ω

STAR WARS: A NEW HOPE (1977)

ILM production documents and Rolodex cards from George Lucas' *Star Wars: A New Hope*. These early production documents display the address of Industrial Light & Magic at its original location in Van Nuys, California.

This set of production documents is a collection of over 60 pages of daily production reports, termination papers, budgets and personnel lists, and includes 16 storyboard copies. A set of Rolodex inserts are also included. These contain contact information for companies used by ILM while working on the film.

Additionally, later documents from a 30th anniversary screening of the film are included in the lot. These documents give a list of the panels which were presented at a screening and provide information about the awards the film was nominated for. The lot shows some signs of wear from storage and use, and is in fine overall condition. Dimensions (largest document): 35.5 cm x 21.5 cm (14" x 8 ½")

£600-800



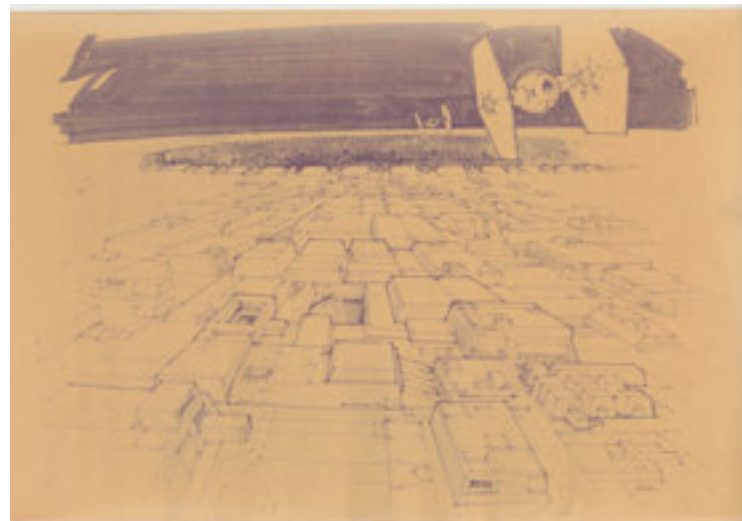

438. Dyeline — TIE Fighters Over Death Star Ω

STAR WARS: A NEW HOPE (1977)

A dyeline of Imperial TIE fighters flying over the Death Star from George Lucas' *Star Wars: A New Hope*. Originally drawn by Joe Johnston, this production copy was created using a dyeline printer before being issued to the Industrial Light & Magic model miniature department.

The dyeline shows two TIE fighters flying over the Death Star. At the bottom right of the dyeline is Joe Johnston's printed signature. The artwork shows wear to the page due to production use and age, including a small tear on the left side, but is in fine rolled condition. Dimensions: 46 cm x 30.5 cm (18" x 12")

Please note this lot is sold without copyright, reproduction rights, licensing agreements or any other type of legal release.

£400-600

439. 'Kit Kat' Death Star Surface ΩΔ

STAR WARS: A NEW HOPE (1977)

A 'Kit Kat' Death Star surface piece from George Lucas' *Star Wars: A New Hope*. This piece was part of a miniature set of the Death Star's immense surface, and was used for medium-altitude shots in which fighters flew over the Imperial station during the Rebel assault.

This variety of surface panel was sometimes referred to during production as the 'Kit Kat' piece, due to its distinctive shape. Designed and built by Industrial Light & Magic's model miniature department, the construction of the Death Star miniatures was a massive undertaking, as the sequence called for a vast battlefield consisting of unique surface panels. Constructed from dense biscuit foam, the surface comprises four connected squares decorated with cast-in greeblies to create an industrial patchwork of parts. The piece is painted black.

The surface shows minor wear due to production use and age, with some chipping to the biscuit foam, but the miniature remains in very fine condition. Dimensions: 28.5 cm x 9 cm x 10 cm (11" x 3 1/2" x 4")

£2,000-3,000

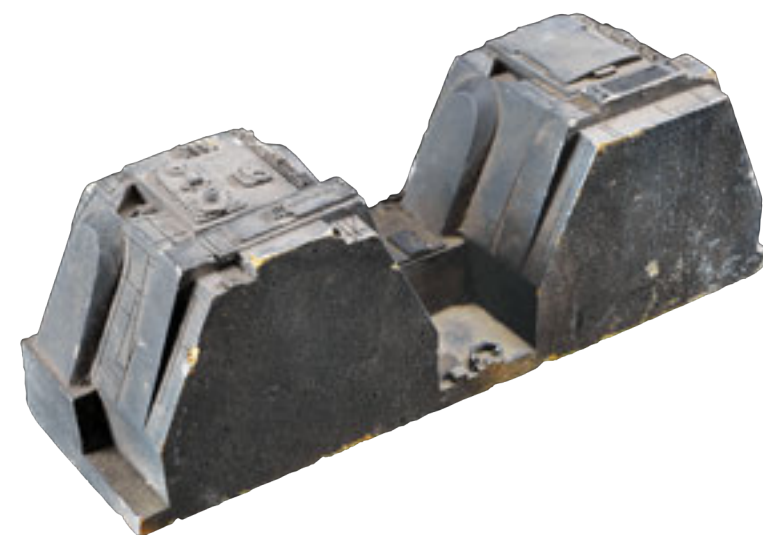

440. 6" x 6" Medium Altitude Death Star Surface Square Ω

STAR WARS: A NEW HOPE (1977)

A 6" x 6" medium altitude Death Star surface square from George Lucas' *Star Wars: A New Hope*. This piece was part of a miniature set of the Death Star's immense surface, and was used for medium altitude shots in which fighters flew over the Imperial station during the Rebel assault. Designed and built by Industrial Light & Magic's model miniature department, the construction of the Death Star miniatures was a massive undertaking, as the sequence called for a vast battlefield consisting of unique surface panels.

Constructed from dense biscuit foam, the surface consists of four connected squares decorated with cast-in greeblies to create an industrial patchwork of parts. The piece is painted industrial grey. The surface shows minor wear due to production use and age, with some chipping to the biscuit foam, but the miniature remains in very fine condition. Dimensions: 15 cm x 15 cm x 8 cm (6" x 6" x 2 1/4")

£4,000-6,000



441. 13" x 12" Low Altitude Death Star Surface ΩΔ

STAR WARS: A NEW HOPE (1977)

A 13" x 12" low altitude Death Star surface panel from George Lucas' *Star Wars: A New Hope*. This piece was used as part of a miniature set of the Death Star's immense surface, specifically for low-altitude shots in which fighters flew close to the station during the Rebel assault. Designed and constructed by Industrial Light & Magic's model miniature department, the construction of the Death Star was a massive undertaking, as the sequence called for a vast battlefield consisting of unique surface panels.

Constructed from dense biscuit foam, the surface is decorated with cast-in greeblies to create an industrial patchwork of parts. Carved into the surface is a grid-like pattern, to simulate panelled construction. The surface is painted in varying shades of grey, giving the piece a cold, mechanical look. This item shows wear due to production use and age, with some chipping to the biscuit foam and paint, and is in fine overall condition.

Dimensions: 34 cm x 30.5 cm x 11.5 cm (13" x 12" x 4 1/2")

£3,000-5,000

442. 12" x 12" Low Altitude Death Star Surface Section †

STAR WARS: A NEW HOPE (1977)

A 12" x 12" low altitude Death Star surface piece from George Lucas' *Star Wars: A New Hope*. 'Miniature' surface sections made up the Death Star's massive surface set, featured in the low-altitude shots when fighters flew in close proximity to the station during the Rebel assault.

Industrial Light and Magic's (ILM) model miniature department constructed the surface, using an assortment of greeblies and etched patterns to create the distinctive details, which were then cast in biscuit foam and painted in shades of grey. There are some small chips to the surface revealing the yellow foam beneath. However, the section remains in very good condition.

Dimensions: 30 cm x 30 cm x 8 cm (11 3/4" x 11 3/4" x 3 1/4")

£3,000-5,000

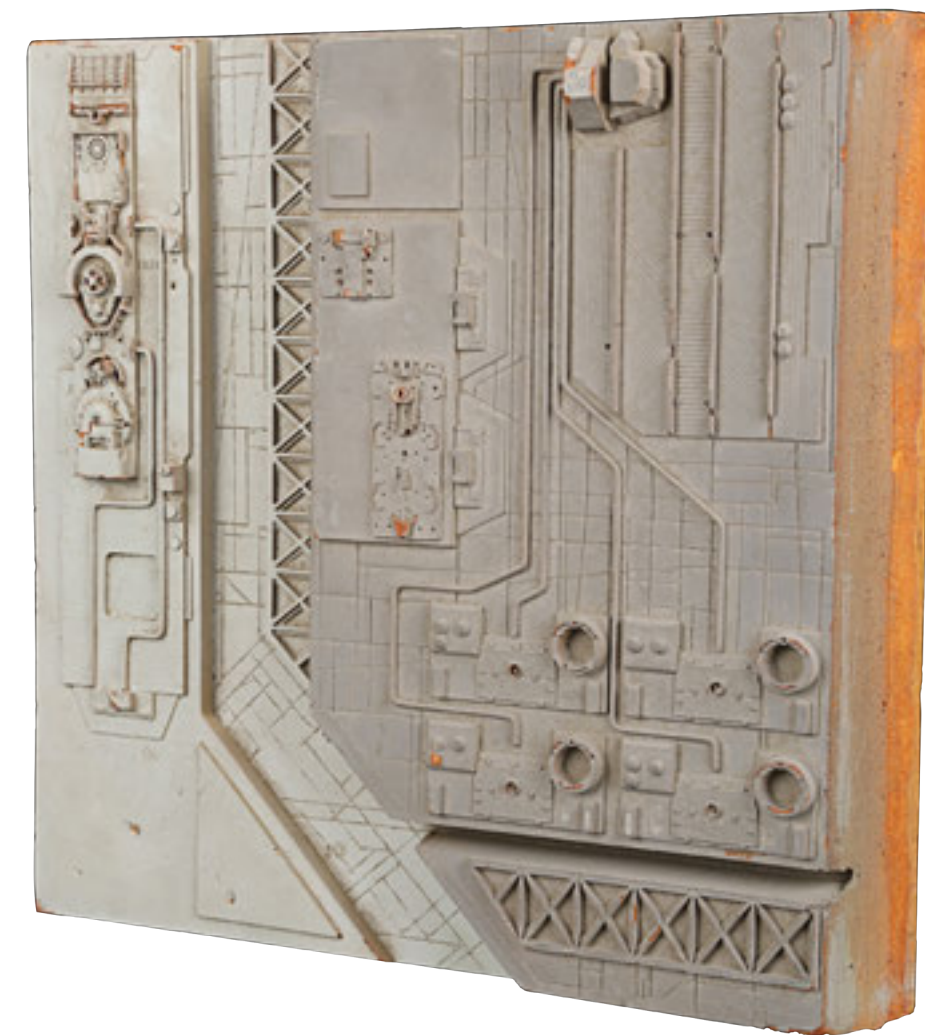

443. 24" x 24" Low Altitude Death Star Surface Piece Ω**STAR WARS: A NEW HOPE (1977)**

A 24" x 24" low altitude Death Star surface piece from George Lucas' *Star Wars: A New Hope*. This piece was used as part of a miniature set of the Death Star's immense surface, specifically for low-altitude shots when fighters flew in close proximity to the station during the Rebel assault.

Designed and built by Industrial Light & Magic's model miniature department, the Death Star's construction was a massive undertaking, as the sequence called for a vast battlefield consisting of unique surface panels. Constructed from dense biscuit foam, the surface is decorated with cast-in greeblies to create an industrial patchwork of parts. Carved into the surface is a grid-like pattern, to simulate panelled construction. The surface is painted in varying shades of grey, with some colourful highlights, giving the piece a cold, mechanical look.

This item shows wear due to production use and age, with some chipping to the biscuit foam and paint. Certain greeblies that protrude furthest from the surface have bits broken off. The lot stands as one of the largest complete Death Star surface panels in existence and remains in good overall condition.

Dimensions: 59.5 cm x 59.5 cm x 7.5 cm (23 1/2" x 23 1/2" x 3")

£12,000-15,000

**444. C-3PO Rear Section Cast** M**STAR WARS: A NEW HOPE (1977)**

A C-3PO rear section cast from George Lucas' *Star Wars: A New Hope*. Originally conceptualised by Ralph McQuarrie, the C-3PO costume was constructed in sections by the prop department to allow actor Anthony Daniels to move as freely as possible while wearing it. A plaster body cast was taken of Daniels, which was sculpted over in clay, to create the robot details. A behind-the-scenes photograph depicts the sculptor Brian Muir overseeing this process. Body plates were ultimately created with vacuum-formed plastic and adhered to the actor's undersuit.

Made of white plastic, the unpainted section features a cast of C-3PO's rear, with uncut excess plastic flashing at the edges. As a result of age, the plastic has become fragile and shows various creases and stains, with cracks and tears on the excess plastic edges.

Dimensions: 43 cm x 55 cm x 15 cm (17" x 21 3/4" x 6")

£1,500-2,000

445. Wallpaper Cuttings M**STAR WARS: A NEW HOPE (1977)**

Two sections of wallpaper from the promotion of George Lucas' *Star Wars: A New Hope*. Wallpaper such as this lined the walls of many children's bedrooms after the release of the blockbuster film in 1977.

Printed on textured wallpaper material, the cuttings have a repeated design which features many scenes from the film, including the Death Star trench run, multiple scenes on board the Death Star, and a scene on the planet Tatooine. One section is fixed to a piece of board and each section has a fold along the left side, with otherwise minimal wear.

Dimensions (each): 93 cm x 53.5 cm (32 1/2" x 21")

£40-60



446. Stormtrooper Blaster M**STAR WARS: A NEW HOPE (1977)**

A stormtrooper blaster from George Lucas' *Star Wars: A New Hope*. E-11 blaster rifles were used by stormtroopers as they hunted the missing droids carrying the Death Star plans and battled the Rebels on the Death Star.

These instantly recognisable blasters were specifically fabricated for the first *Star Wars* film by renowned armourers Bapty, who also created weapons for *The Empire Strikes Back*. As the budget for the first film was very tight, efforts were made to limit the number of shoot days requiring on-set armourers, as well as the cost to export the weapons overseas for filming in Tunisia. Special non-functioning versions of the blasters were fabricated to replicate the appearance of the live-fire L2A2 Sterling versions, allowing them to be safely carried on set without armourer supervision.

Finished in black paint, the blaster comprises a Sterling body tube containing a central wooden dowel barrel and custom aluminium components, which replace the receiver, magazine well, stock, pistol grip and trigger guard.

A large number of the weapons were ultimately returned to Bapty after *A New Hope* wrapped. When rediscovered many years later in the Bapty armoury, the weapon had been stripped of various parts, and has subsequently been carefully restored by Prop Store. The restored pieces include a resin M38 scope, a steel scope rail made to the exact same dimensions as original scopes found at Bapty, plastic "T-track" strips along the barrel, magazine cylinders and a Hengstler counter box adhered to one side. The lot has been carefully restored and displays signs of production use and age, including minor corrosion, paint wear and marks, notably on the grip.

Dimensions: 51 cm x 13 cm x 22 cm (20 ¼" x 5 ¼" x 8 ¾")

£30,000-50,000



447. Stormtrooper Helmet †

STAR WARS: A NEW HOPE (1977)

A stormtrooper helmet used in George Lucas' Star Wars: A New Hope. The stormtroopers represented the physical enforcement of the Galactic Empire throughout the first installment of the seminal saga, and now rank among the most recognisable movie characters of all time.

The legendary design of the stormtrooper began with a concept sketch by Ralph McQuarrie in 1975. The physical form was crafted by sculptor Liz Moore (though Brian Muir sculpted the body armour) and vacuum-formed by an outside vendor.

This helmet is constructed from high-density polyethylene, or HDPE, a material used at that time to line ponds. The grey-green plastic was deemed the ideal material in which to fashion the complex, curved design. The helmets were then

spray-painted with a white finish. Approximately 56 helmets were produced for filming; only a small number are known to exist in private collections today.

This helmet is stripped of its original paint and was re-sprayed white; the re-sprayed finish has been partially sanded in preparation for a more comprehensive restoration that was never completed. The ears are missing and there is a split at the lower rear of the piece. The original mic tips in the chin of the helmet are also present, though they have been stripped of their black paint. The green eye lenses, the rubber strips on the forehead and around the neck opening, and the pop rivets holding the helmet together are replicas added for display purposes.

Dimensions: 32 cm x 31 cm x 28 cm (12 ½" x 12" x 11")

£40,000-£60,000



448. Mike Vosburg and Steve Leialoha Hand-Drawn Page 35 Artwork Ω

STAR WARS ANNUAL #1 (1979)

Hand-drawn page 35 artwork by Mike Vosburg and Steve Leialoha featuring Princess Leia Organa, Han Solo, Chewbacca and Kharys the Majestrix from *Star Wars Annual #1*. The page features six panels showing Leia discovering Han Solo and Chewbacca in the Majestrix's interrogation room.

This original pencilled-and-inked artwork is drawn on Bristol board by penciller Mike Vosburg and inker Steve Leialoha. The page shows "Star Wars" stamped at the top, and it has been signed by Steve Leialoha in the top right corner. A single speech balloon is pasted on the centre panel next to the Majestrix, and is noted by the editor in blue pencil on the right side of the page. On the back of the artwork is a Marvel Comics Group stamp.

Included with the lot is a reference copy of *Star Wars Annual #1*, the comic book in which this art was originally published. Some white-out correction fluid is present, along with aged tape on the back. The artwork shows a cut at the top right corner, but it remains in very good condition. Dimensions: 40 cm x 27 cm (15 3/4" x 10 1/2")

Please note this lot is sold without copyright, reproduction rights, licencing agreements or any other type of legal release.

£700-900



449. Mike Vosburg and Steve Leialoha Hand-Drawn Page 43 Artwork Ω

STAR WARS ANNUAL #1 (1979)

Hand-drawn page 43 artwork by Mike Vosburg and Steve Leialoha featuring Luke Skywalker and Kharys the Majestrix from *Star Wars Annual #1*. The page features nine panels showing Luke engaged in a lightsaber duel with the Majestrix.

This original pencilled-and-inked artwork is drawn on illustration board by penciller Mike Vosburg and inker Steve Leialoha. The page shows "Star Wars" stamped at the top and it has been signed by Steve Leialoha in the top right corner. On the back of the artwork is a Marvel Comics Group stamp, along with a music playlist written in blue pencil. Some white-out correction fluid is present.

Included with the lot is a reference copy of *Star Wars Annual #1*, the comic book in which this art was originally published. The artwork shows a cut at the top right corner, but it remains in very good condition.

Dimensions: 40 cm x 27 cm (15 3/4" x 10 1/2")

Please note this lot is sold without copyright, reproduction rights, licencing agreements or any other type of legal release.

£700-900



450. Don Post Stormtrooper Statue US

STAR WARS: A NEW HOPE (1977)

A Don Post stormtrooper statue from George Lucas' *Star Wars: A New Hope*. The statue was crafted by Don Post Studios as part of a limited-edition run, with this piece being numbered 137.

Made of fibreglass, the statue has been sculpted to resemble the uniform worn by Imperial stormtroopers. Similar to a mannequin, the statue's arms can be removed with ease. Standing with a blaster that is fixed to the right hand and supported by the left, the statue rests atop a custom-made base, which features a plaque with the *Star Wars* logo and edition number engraved into it. The statue shows minor wear and chips to the paint, but remains in very good overall condition.

Dimensions: 48 cm x 104 cm x 181.5 cm (19" x 41" x 71")

£6,000-8,000

451. Don Post Life-size Boba Fett Statue US

STAR WARS: RETURN OF THE JEDI (1983)

A Don Post life-size Boba Fett statue from Richard Marquand's *Star Wars: Return of the Jedi*. Made utilizing original reference materials, this statue was crafted by Don Post Studios in 1996 as part of a limited-edition run, with this piece being numbered 098.

Made largely of fiberglass with a fabric undersuit, this piece has been painted to appear scratched and worn and features all of Boba Fett's signature components, including a pair of grey trousers and matching jacket, tan shoulder and knee guards, and a green chest plate. The statue features a backpack and utility belt which exhibits various pouches of static weaponry, including one pouch that houses a switch that powers a light-up screen on the left side of the armor.

Boba Fett's helmet features an eyepiece extension that can be rotated up and down and lit up at the push of a switch. Boba Fett rests on a base which features a plaque displaying the Star Wars logo and edition number engraved into it. The exterior of the eyepiece is loosened when the switch is flipped and the black visor on the helmet shows cracks to the plastic. However, the statue remains in otherwise good condition. Dimensions: 48 cm x 84 cm x 203 cm (19" x 33" x 80")

£3,000-10,000



452. Replica Darth Vader Costume M

STAR WARS: THE EMPIRE STRIKES BACK (1980)

A replica Darth Vader costume from Irvin Kershner's *Star Wars: The Empire Strikes Back*. Five hundred limited-edition statues of the Sith Lord were created in 1997 by replica costume and prop company Rubies, in collaboration with special-effects artist Michael Burnett.

Standing at seven feet tall, the costume consists of Vader's iconic helmet, a long-sleeved tunic, a sleeveless cape-like tunic, pauldrons, chest armour, an over cape, a chest control box, a pair of gauntlets, a belt, a pair of padded trousers and a pair of black leather heeled boots.

Finished in a gloss black, the helmet is made from a combination of vacuum-formed plastic and fiberglass components. It displays metallic billets and detailing for the mouthpiece. The base layer of the costume is made of padded leather with decorative vertical stitching lines, producing a quilted appearance. A thin black chain is attached to the cape and adorns the front of the chest armour.

Made of resin, the front chest control box contains internal electronics and displays multiple faux-silver and coloured plastic components. The belt features two plastic boxes decorated with green buttons, and a holster containing a lightsaber hilt, which is made of metal.

The costume is displayed on a wooden base finished in grey, with a presentation plaque stating this is number "407 of 500" made. The back of the helmet and one of the boots display exposed wiring. The lot displays minor wear, including scratches on the control box, paint splatters on one of the gauntlets and damage to the display base.

Dimensions: 49 cm x 99 cm x 213 cm (19 1/2" x 39" x 84")

As this item contains electronic components, every effort has been made to describe them accurately. However, no guarantee or warranty is made as to the functionality, lifespan or safety of those components. It is entirely incumbent on the new owner to satisfy themselves as to their safe use and maintenance.

As this item is oversized it will require a specialist shipping service with additional costs. Please contact us prior to purchasing to request a quote.

£6,000-8,000



453. Location Reconnaissance and Assorted Ephemera †Δ

STAR WARS: THE EMPIRE STRIKES BACK (1980)

Location reconnaissance and assorted ephemera from Irvin Kershner's *Star Wars: The Empire Strikes Back*. Printed on white A4 paper, the location reconnaissance contains data gathered prior to filming, to calculate whether the logistics of the selected locations would work.

Created for use during the production, the set of ephemera consists of five sheets of A4 paper with production letterheads, a fact book and a faux-silver invitation to a principal photography wrap party held at Elstree Studios. The location documents show minor wear from production use, including folded corners, marks and scratches. Dimensions (paperwork): 30 cm x 21 cm x 1.5 cm (12" x 8 ¼" x ¾"); (invitation): 21 cm x 10 cm x 0.1 cm (8 ¼" x 4" x ¼")

£300-500



454. Pair of Tauntaun Stop-Motion Sequence Paper Slates Ω

STAR WARS: THE EMPIRE STRIKES BACK (1980)

A pair of tauntaun ILM paper slates from Irvin Kershner's *Star Wars: The Empire Strikes Back*. Phil Tippett animated the tauntauns for the film using stop-motion. These paper slates were used to separate shots during the opening sequence, and Han's (Harrison Ford) search for Luke (Mark Hamill).

The slates are printed on paper with an ILM letterhead, and show boxes printed for the "roll no.", "date", "scene", "sequence", "take no.", and "element" fields, which are filled out with marker. The piece is dated "3-5-80", with the sequence noted as "opening". The slates show wear due to age and production, with one sheet including a folded strip of tape adhered to the top right corner, with the bottom right corner torn away. Dimensions: 22 cm x 28 cm (8 ½" x 11")

£800-1,200

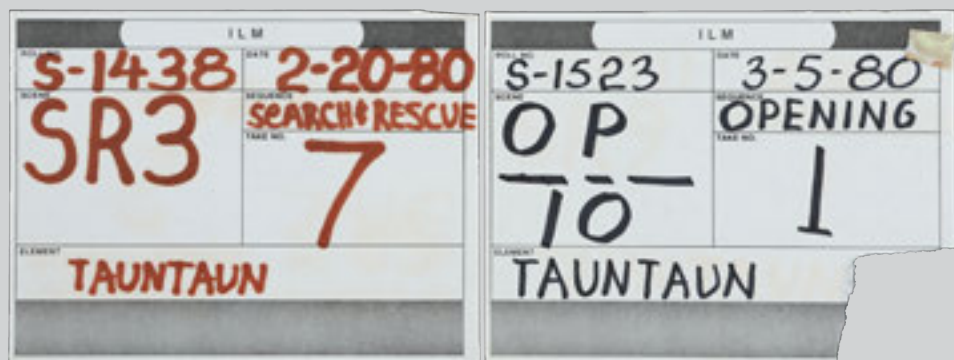

455. Brian Johnson's Personal Script M

STAR WARS: THE EMPIRE STRIKES BACK (1980)

A partial script from the production of Irvin Kershner's *Star Wars: The Empire Strikes Back*. Leigh Brackett wrote the first draft but after her death in March 1978, Lucas rewrote it to become this second draft. Given to Oscar®-winning special effects artist Johnson personally by Lucas, this gave the special effects team a feel for the opening of the movie on the ice-planet Hoth, the rest of which had likely yet to be written.

The pages are bound in a yellow card cover stamped in blue ink detailing Johnson's department, and his name hand-written in black ink above. The script comprises of 24 single-sided white pages and is dated April 1978, credited to Leigh Brackett and George Lucas. Some of the story content differs from the final cut, including describing the Tauntaun creatures as lizards. The final page lists subsequent Hoth scene details. The script remains in good condition with light wear and marks to the cover. Dimensions: 0.5 cm x 22 cm x 28 cm (¼" x 8 ¾" x 11")

£1,000-1,500

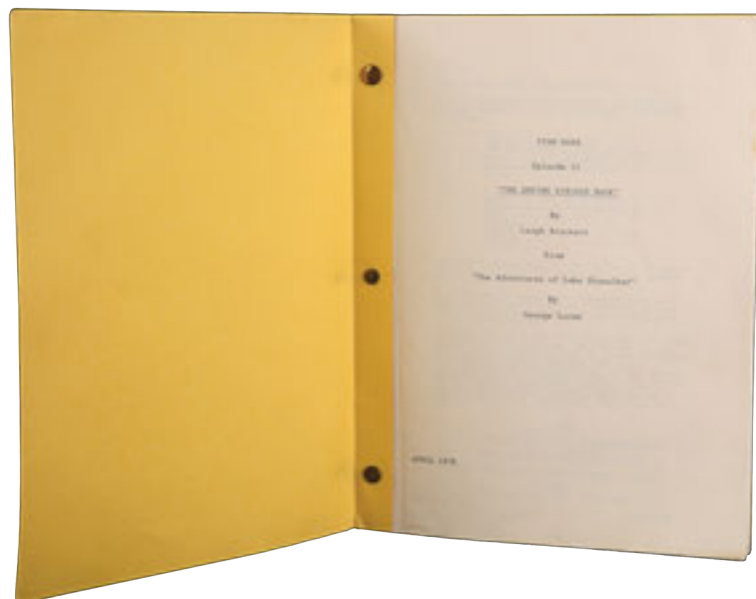

456. Irvin Kershner Autographed Photograph M

STAR WARS: THE EMPIRE STRIKES BACK (1980)

An autographed photograph of director Irvin Kershner on the set of *Star Wars: The Empire Strikes Back*. The photograph shows Kershner looking ahead and leaning towards a Panavision camera, which has a Darth Vader promotional patch adhered to it. Kershner's has signed in silver-coloured marker on the left side. The photograph displays a minor surface scratch.

Dimensions: 20 cm x 25.5 cm (8" x 10")

£200-300

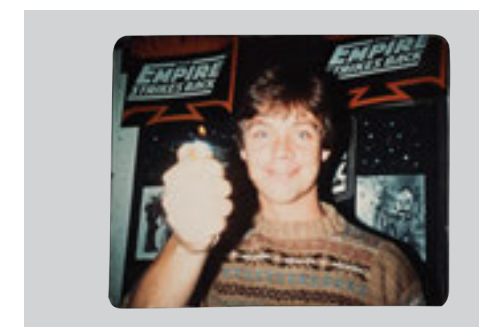

457. Mark Hamill Autographed Vintage Forbidden Planet Flyer M

STAR WARS: THE EMPIRE STRIKES BACK (1980)

A vintage Forbidden Planet flyer autographed by Mark Hamill. The flyer was distributed by the legendary London comic-book store to promote an event, which boasted Dave Prowse and Anthony Daniels as attendees, just prior to the release of *The Empire Strikes Back*. The two-day event on 22 and 23 May 1980 also promised a visit from one of the "American stars", namely Mark Hamill. The flyer is autographed in blue ballpoint, also included are two candid colour photos of Hamill at the event.

Dimensions (flyer): 21 cm x 15 cm (8 ¼" x 6")

£400-600



458. Title Logo Paperweight †Δ

STAR WARS: THE EMPIRE STRIKES BACK (1980)

A title logo paperweight given to cast and crew members working on the set of Irvin Kershner's *Star Wars: The Empire Strikes Back*. Cast from pewter, the square-shaped piece features rounded corners and the film's renowned title artwork on both sides. The outside edges and the film's angled logo are finished in a metallic dark grey, and the lot comes presented in a thin blue box. Minor scratches and paint wear are present on the paperweight and the box displays signs of use, including creases, small rips and damage to the blue finish.

Dimensions (out of box): 7 cm x 8.5 cm x 0.5 cm (2 ¾" x 3 ½" x ¼"); (within box): 9 cm x 10 cm x 1 cm (3 ¾" x 4" x ½")

£500-700

459. Bespin Guard Uniform †

STAR WARS: THE EMPIRE STRIKES BACK (1980)

A Bespin Guard uniform from Irvin Kershner's *Star Wars: The Empire Strikes Back*. The Bespin guards appeared on Cloud City and were administered by Lando Calrissian (Billy Dee Williams), under the control of his cyborg aide Lobot (John Hollis).

The uniform comprises a blue cotton collarless jacket and matching pair of trousers. Decorative faux-gold braid has been applied to the jacket and the sleeve cuffs are burgundy with a black trim. The jacket is sealed with green-coloured Velcro and a zip-and-hook fastening feature on the front of the trousers. Two pieces of black elastic are pinned to the hem of the trousers. The uniform displays signs of wear, including frayed seams on the inside of trousers, and a section of the braid has become unattached at the back of the jacket neckline.

£4,000-6,000



460. Jason Palmer Hand-Painted 25th Anniversary Celebration III Artwork Ω

STAR WARS: THE EMPIRE STRIKES BACK (1980)

Hand-painted artwork by Jason Palmer for *Star Wars* Celebration III, honouring Irvin Kershner's *Star Wars: The Empire Strikes Back*.

The mixed media artwork is rendered on sturdy illustration board using airbrush, watercolours and pastels. Presented in a landscape format, the art shows the principal cast members overlapping with key moments from the film, such as the Battle of Hoth, the asteroid chase, and Luke's showdown against Darth Vader inside Cloud City on Bespin. At the bottom right of the work are the artist's initials.

Dimensions: 81 cm x 48 cm x 1 cm (32" x 19" x ¼")

£2,200-2,600

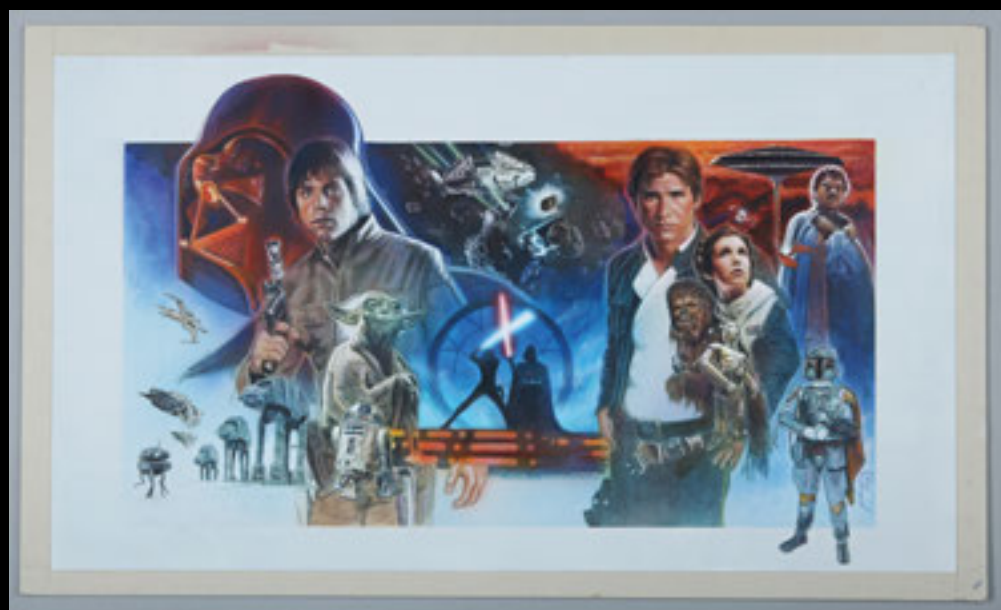

ScreenProd / Photononstop / Alamy Stock Photo



The cynical space pirate's costume remained largely unchanged throughout the original trilogy. Costume designer John Mollo, who won one of his Oscars for his work on the original Star Wars: A New Hope, described Han Solo's look as "a mixture of a cowboy and a more orthodox space sort of thing." The straightforward garb spoke to George Lucas's description of the character in the fourth draft of Star Wars: "A mercenary in a starship, simple, sentimental and cocksure of himself."

The jacket is the only significant Han Solo costume piece from the original trilogy ever to come to public auction. It featured prominently on marketing materials and consumer products relating to the film, including the famous 'Gone With the Wind'-style theatrical poster featuring artwork by Tom Jung. Countless pieces of merchandise have been created featuring the jacket, ranging from drinking glasses to action figures. It is the embodiment of one of the most revered characters in cinema.

The Empire Strikes Back remains a high-point of the Star Wars saga. A 2014 Empire magazine list of great movies, as voted by fans, listed Empire as the greatest motion picture ever made. It was the highest grossing film of 1980, earning nearly twice as much as the number-two earner and at that time was the third-highest

grossing film in history, behind only the original Star Wars and Jaws. The film has the honour of being selected to be archived by the U.S. Library of Congress.

Academy-Award nominated Harrison Ford is one of the world's most beloved actors, having portrayed Han Solo in addition to George Lucas's other brainchild—Indiana Jones, as well as many other timeless characters. Ford received the AFI Life Achievement Award in 2000, and in 1997 was ranked by Empire Magazine as number one on a list of "The Top 100 Movie Stars of All Time."

This historic piece has been conserved by noted textile conservationists Janie Lightfoot & Co. and displays only minor instances of loose threading and minimal wear as a result of production use. It is presented on a bust display and remains in excellent condition. Included with the jacket are several 8x10 reference photos including production stills and screen captures.

Dimensions (displayed): 58 cm x 68 cm x 167 cm (22 ¾" x 26 ¾" x 65 ¾")

£500,000 - £1,000,000

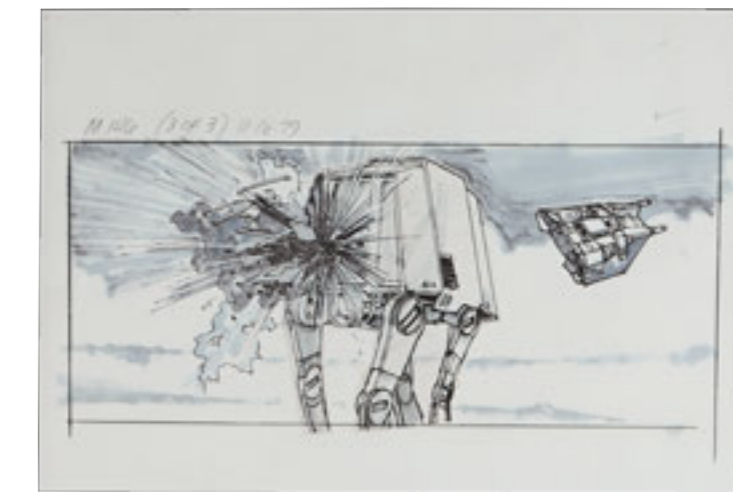
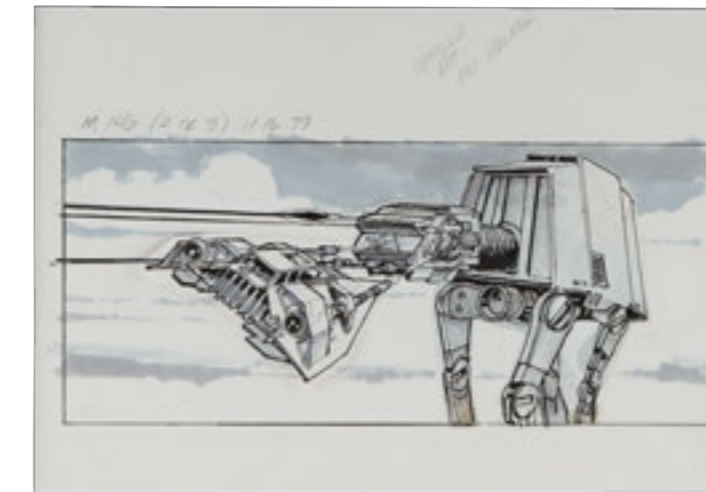

461. Dave Carson Hand-Drawn Imperial Walker Storyboards Ω

STAR WARS: THE EMPIRE STRIKES BACK (1980)

A pair of hand-drawn Imperial walker (AT-AT) storyboards from Irvin Kershner's Star Wars: The Empire Strikes Back.

Illustrated by Industrial Light & Magic artist Dave Carson using pen and marker on paper, the first storyboard is labelled "M146 (2 of 3)", dated "11-16-79", and shows a rebel snowspeeder firing on an AT-AT at close range during the Battle of Hoth.

The second storyboard is labelled "M146 (3 of 3)", dated "11-16-79", and shows the same rebel snowspeeder flying off to the right of the AT-AT it has just attacked.

The storyboards are displayed in a bespoke wooden frame, and both storyboards remain in very fine condition. Dimensions (each): 25.5 cm x 18 cm (10" x 7"); (frame): 67.5 cm x 31 cm x 2.5 cm (26 ½" x 12 ¼" x 1")

Please note this lot is sold without copyright, reproduction rights, licencing agreements or any other type of legal releases.

£2,000-3,000



462. Set of Assorted Crew Patches M

STAR WARS: THE EMPIRE STRIKES BACK (1980)

A set of assorted crew patches from the production of Irvin Kershner's *Star Wars: The Empire Strikes Back*. Numerous designs were offered to crew members, who used them to customise their snowsuits for filming in the Norwegian tundra.

The lot comprises nine embroidered patches, featuring an assortment of designs and text based on the *Star Wars* sequel, from companies that worked on the production to designs featuring the Sith Lord Darth Vader. A shield-shaped patch shows a printed mountain scene with the text "Ustaoset, Høyfjellshotel", one of the production's filming locations.

The set is completed by a laminated white patch featuring the film's title printed in blue. Several of the embroidered patches display minor plucks, and the laminated patch exhibits small marks on the front.

Dimensions (largest patch): 13 cm x 8.5 cm x 0.2 cm (5 ¼" x 3 ½" x ¼")

£600-800

463. Han Solo's (Harrison Ford) Jacket M

STAR WARS: THE EMPIRE STRIKES BACK (1980)

Han Solo's (Harrison Ford) jacket from Irvin Kershner's *Star Wars: The Empire Strikes Back*. The Empire jacket was a subtle update of Solo's vest from the original film, maintaining a similar pocket configuration and cut, with the addition of sleeves and a collar.

This exact jacket Solo jacket was used for sequences on Cloud City and screen matches numerous shots in the film. Unique identifiers include the placement, sizing, and fold lines of the pockets, as well as a specific internal stitch-line within the collar that is visible in a close-up shot of Ford. At least one other jacket was used for filming and the jackets can be differentiated by the their pocket placement.

Designed by Academy Award®-winning costume designer John Mollo, the jacket was manufactured by the small independent tailor Caledonian Costumes, a firm started by former Bermans & Nathans employee Victor Somkowitz.

Made of a cotton woollen blend with a polyester satin lining, it features a mandarin collar, pockets on both sides at the chest and waist, a large pocket on the rear,

a faux-pocket on the left arm, shoulder panel detailing and visible stitched detailing at the upper arm, elbow and cuffs. It shares several styling and cut details with Luke Skywalker's (Mark Hamill) jacket worn on Dagobah and in Cloud City, notably the stitched detailing on the arms.

Several colours were considered before the final design was selected, in consultation with George Lucas and director Irvin Kershner. Although it appeared navy blue in the film, the jacket is deliberately a blue-grey colour. Designer Mollo stated that blues tend to appear black on film, and for that reason a garment intended to read as blue needed to be made in a lighter colour.

The jacket does not display any fasteners as it was designed to be worn open, as with Solo's vest in *A New Hope*. Lucas famously did not want any visible fasteners on the costumes of *Star Wars* as he felt they were too close to the styling of modern-day Earth. The creator of *Star Wars* felt he did not want the costumes to stand out in the film. Mollo stated that Lucas instructed him that the costumes of the films should not appear "spacey."

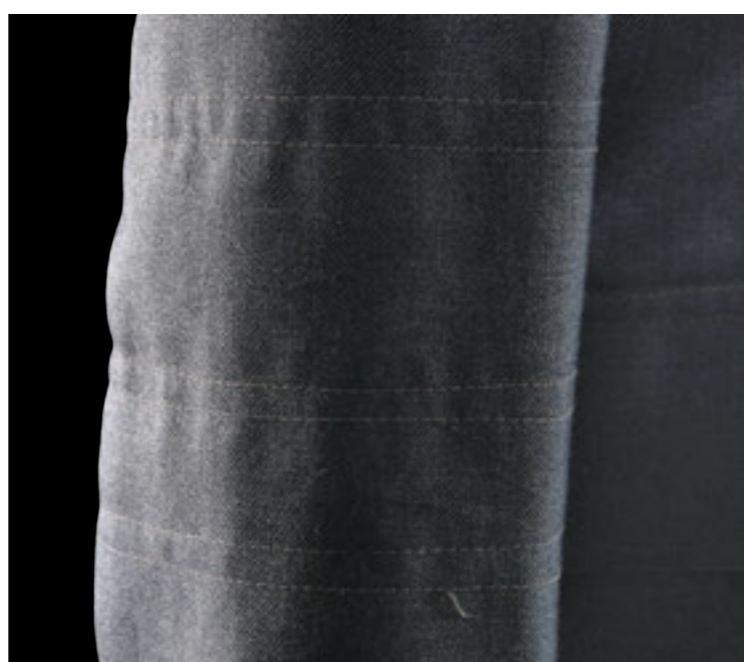

464. Han Solo's (Harrison Ford) Welding Goggles M

STAR WARS: THE EMPIRE STRIKES BACK (1980)

Han Solo's (Harrison Ford) welding goggles from Irvin Kershner's *Star Wars: The Empire Strikes Back*. Solo wore his goggles while he attempted to repair the Millennium Falcon's hyperdrive in an asteroid, shortly before narrowly escaping the titanic space slug residing there.

Inspired by the concept of a used future, *Star Wars* creator George Lucas designed the original series to look dirty and dingy, with technology being constantly reused long past its prime. The Millennium Falcon is an old junk heap that runs on a wing and a prayer, seemingly held together with leftover scrap and her crew's sheer force of will, always needing Solo to patch it back together.

To create a believable performance and reduce the need for visual effects, the goggles were designed for functional use and protected Ford's eyes when he acted with a real, working welding torch during the scene.

Constructed from commercial off-the-shelf components that were readily available in the 1980s, the goggles consist of a black plastic frame housing two pairs of lens. The lens surround can be unscrewed; when doing so, it reveals that one of the lens pairs are made of tinted glass, designed to reduce the brightness of welding sparks. At the centre of the goggles, secured by a small metal fastening, is a brown faux-leather guard, moulded to fit Ford's nose.

The goggles are displayed on a custom-made stand, but the elastic band that secured them to Ford's head is no longer present. As a result of age and production use, the eyewear shows very minor paint wear on the frame and surface scratches on the lens.

Dimensions (displayed): 14 cm x 17 cm x 25 cm (5 1/2" x 6 3/4" x 10")

£10,000-15,000



465. UK Style A Quad †Δ

STAR WARS: THE EMPIRE STRIKES BACK (1980)

A UK Style A quad poster (F linen-backed condition) from Irvin Kershner's *Star Wars: The Empire Strikes Back*. As the initial release of *The Empire Strikes Back* was in London, many posters were framed and displayed in the London Underground. For three years, London Underground trimmed UK quad posters as their dimensions were too big for the frames they used.

an orange background, which was later changed to darker tones, making this design particularly rare. Originally folded, the poster has been carefully restored along its fold lines, exhibits a small restored tear, and displays light wear around the edges.

Dimensions: 103 cm x 71 cm (40 1/2" x 28")

£3,000-4,000

Referred to as the "Gone with the Wind" style, the linen-backed poster features painted artwork by award-winning artist Roger Kastel, who also produced work for *Jaws* and *Doc Savage*. The poster features Han Solo and Princess Leia against



466. AFA-Graded Han Solo Palitoy Action Figure M

STAR WARS: THE EMPIRE STRIKES BACK (1980)

A Han Solo action figure, graded by the Action Figure Authority (AFA), from *Star Wars: The Empire Strikes Back*. Housed in its original box, the Palitoy figure shows the Millennium Falcon captain in his Bespin outfit. The front of the box displays an image of Han Solo (Harrison Ford) with the *Star Wars* logo printed above in white and red, and the back shows the 45 figures that were part of the collection.

Adhered to the bottom of its plastic protective casing is an AFA sticker with the toy's grading figure (70 EX+). Minor wear and damage are present on the back and edges of the box, and the action figure shows some paint wear.

Dimensions: 25 cm x 18 cm x 4 cm (10" x 7 1/4" x 1 3/4")

£300-500



467. Darth Vader Helmet Cast M

**STAR WARS:
THE EMPIRE STRIKES BACK (1980)**

A Darth Vader helmet casting from Irvin Kershner's *Star Wars: The Empire Strikes Back*. Vader wore his signature helmet throughout the film as he continued to pursue Luke Skywalker (Mark Hamill) and the Rebel Alliance.

The cast was taken from original production moulds during the making of the film and cast in black fibreglass. It was ultimately not needed for shooting and therefore never finished. The helmet is assembled in two parts; the mask and the dome which have been crudely pieced together with Velcro and masking tape, with silver-painted detailing on the screws around the mouth vent. The lenses are made from vac-form plastic, with metal mesh crudely glued to the inside of the mask for the chin vent. The casting, which originated from a crew member on the film, is accompanied by a framed invitation to the London Premiere of *The Empire Strikes Back* in Leicester Square on Sunday 4th May 1980. The Velcro has begun to come away from the helmet as a result of age, however it remains in good overall condition.

Dimensions (assembled): 37 cm x 33 x 37 cm (14 1/2" x 13" x 14 1/2")

£2,000-3,000

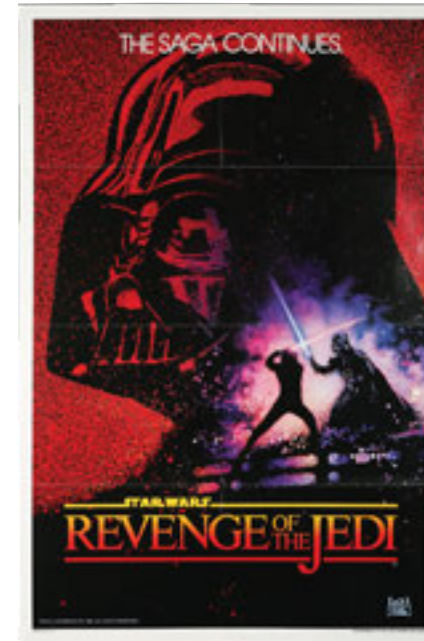

469. US One-Sheet Teaser Poster M

STAR WARS: RETURN OF THE JEDI (1983)

A US one-sheet teaser poster (tri-folded G condition) from Richard Marquand's *Star Wars: Return of the Jedi*. Designed by Drew Struzan, the poster features an illustration of Darth Vader's helmet, with Luke Skywalker (Mark Hamill) and the Sith Lord dueling with lightsabers.

The artwork displays the title "Revenge of the Jedi", the original name of the sixth episode, which was ultimately renamed for the film's release by George Lucas. Two versions of the poster were created; a dated version and an undated version, with this example being one of the latter iterations. Only a small number of the undated versions made it to theatres, making this variety of the poster a rarer find. The lot displays prominent fold lines.

Dimensions: 104 cm x 68.5 cm (41" x 27")

£800-1,200



470. Carrie Fisher Autographed Photograph M

STAR WARS: RETURN OF THE JEDI (1983)

An autographed promotional photograph from Richard Marquand's *Star Wars: Return of the Jedi*. The photograph shows a close up of Princess Leia (Carrie Fisher) on the Forest Moon of Endor.

The photo has been autographed by Fisher in black marker, and she refers to herself as "Jabbas girlfriend" and displays a message addressed to "David". The date "18-03-98" and the numbers "47/5" have been written in pencil on the back. Minor marks are present on the back and the photograph displays light wear to the top left corner.

Dimensions: 25.5 cm x 20.5 cm (10" x 8")

£100-150



468. Dennis Muren's Personal Miniature Storyboard Set Ω

STAR WARS: RETURN OF THE JEDI (1983)

Dennis Muren's personal miniature storyboard set from Richard Marquand's *Star Wars: Return of the Jedi*. Issued to visual effects artist Dennis Muren, this collection includes 162 storyboards from numerous FX sequences, including Jabba's Palace, the Endor bike chase and the Battle of Endor. Storyboard sets such as this were on hand during the production as a visual reference guide for complicated sequences.

The printed storyboards have been reduced in size from the original artwork and are bound together with a front-and-back card cover. Storyboard sets were reduced in size in order for technicians to have manageable copies handy as they worked on set. Each page includes an ILM stamp for studio-tracking purposes. The paper shows minor wear due to production use, but remains in fine condition. Dimensions: 14 cm x 12 cm x 2 cm (5 1/2" x 4 3/4" x 3/4")

Please note this lot is sold without copyright, reproduction rights, licensing agreements or any other type of legal release.

£1,500-2,500



471. Richard Marquand "Revenge of the Jedi" Crew Gift Plate M

STAR WARS: RETURN OF THE JEDI (1983)

A crew gift plate from Richard Marquand's *Star Wars: Return of the Jedi*. The director gifted plates to the heads of department who worked on the production.

Handmade by the Chelsea Pottery, the glazed piece displays a light-and-dark brown finish, with the film's original title "Revenge of the Jedi" and the year of filming "1982" decorating the front. Two holes are present at the rear, allowing it to be displayed on a wall. The plate displays minimal wear from use, with minor marks on the back.

Dimensions: 18.5 cm x 18.5 cm x 3 cm (7 1/4" x 7 1/4" x 1 1/4")

£600-800

213.5cm x 89cm
(84" x 35")

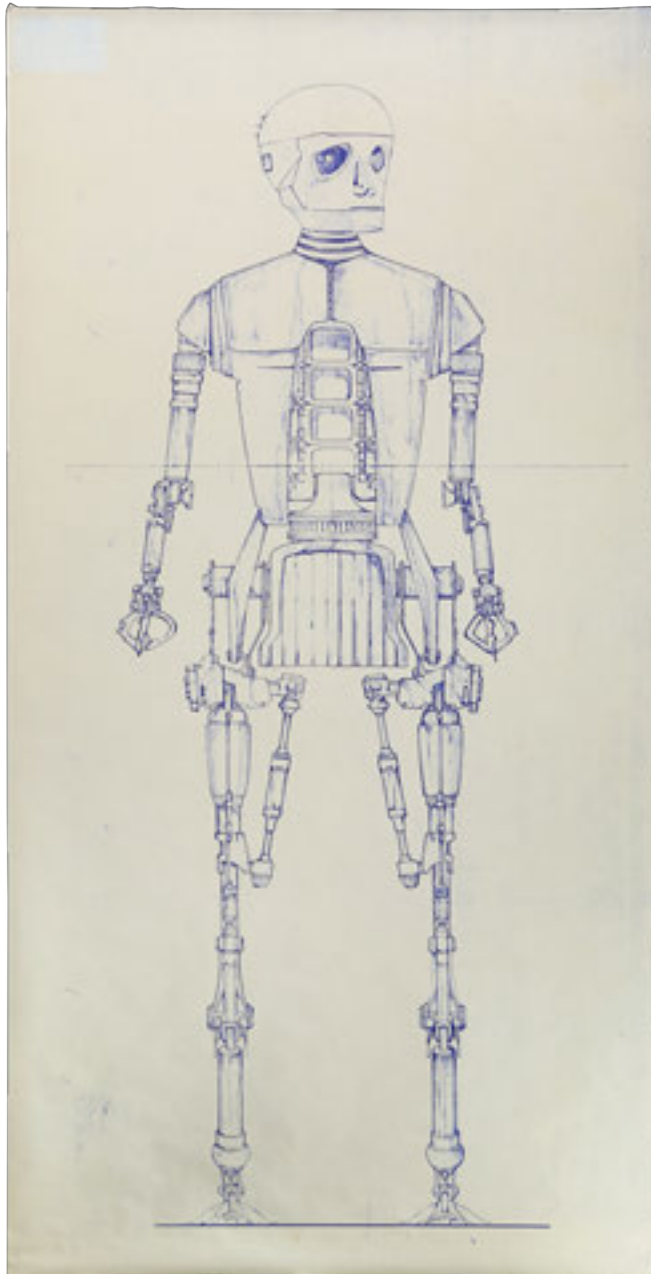

472. Full-Size 8D8 Blueprint ΩΔ

STAR WARS: RETURN OF THE JEDI (1983)

A full-size 8D8 droid blueprint copy from Richard Marquand's *Star Wars: Return of the Jedi*. This blueprint is a modern reproduction taken from a production-used original for an unrealised book project. 8D8 was a droid programmed to torture other droids in Jabba's Palace.

This large blueprint is an early design for 8D8 and shows slight differences to the final appearance of the character. The copy is made from a hand-drawn original by an unnamed draftsman working under the art directors and production designers for the film. The piece is labeled in the bottom left corner, though the writing is faded and difficult to read. The blueprint shows only minor wear and wrinkles throughout and is in fine overall condition.

Dimensions: 213.5 cm x 89 cm (84" x 35")

Please note this lot is sold without copyright, reproduction rights, licensing agreements or any other type of legal releases.

£1,000-1,500

473. Ewok Mask and Fur Set †Δ

STAR WARS: RETURN OF THE JEDI (1983)

An Ewok mask and fur set from Richard Marquand's *Star Wars: Return of the Jedi*. The furry Ewoks helped the Rebels battle Imperial stormtroopers on the forest moon of Endor. This unassembled, unfinished set of components was created for the production by make-up designer Stuart Freeborn and his team, ready to be turned into another of the bold creatures should it have been required for filming.

Made of foam latex and rubber, the set includes a full face mask, solid castings of two tiny feet, six hollow toe castings complete with nail detail, and five sections of foam-latex flashing from the manufacturing process. Also included are a set of prosthetic Ewok teeth and denture moulds, one of which is hand-marked "JP", and two spherical amber plastic eye moulds, uncut from their square flanges. The collection is completed by two strips of grey-brown Ewok fur.

Each foam-latex item is intact but shows notable staining and wear from use during production. The small latex feet have thin latex flashing around their circumference, each indicating where they were attached to a larger piece. The mask displays signs of aging, including cracks and tears around the back and edges. Each of the toes shows cracking around the edges, while the teeth exhibit light marking and discolouration.

£2,000-3,000

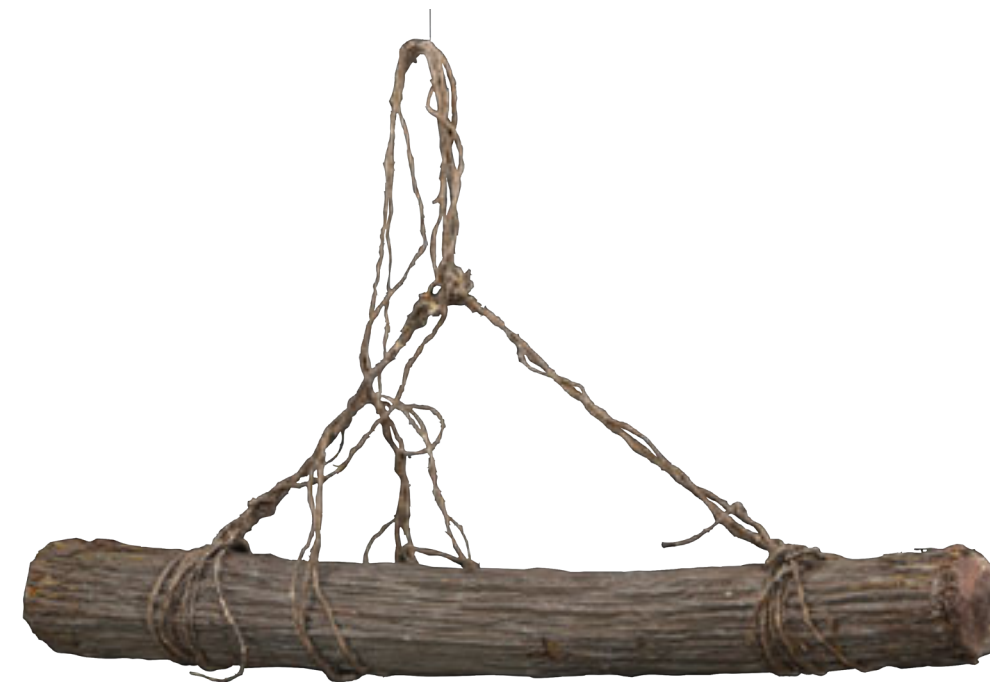

474. Model Miniature Ewok Log Used For AT-ST Smashing Ω

STAR WARS: RETURN OF THE JEDI (1983)

A model miniature Ewok log, used for smashing an Imperial AT-ST, from Richard Marquand's *Star Wars: Return of the Jedi*. Ewoks used a pair of tree trunks rigged as a trap to pummel a formidable AT-ST during the battle of Endor.

This faux log is made of biscuit foam which has been textured and furnished with pieces of real tree bark for realism. Each end is capped with a small, circular piece of wood. A small metal pin is also present at one end; this served as an anchoring point for the log during production. The piece is wrapped with twine, which appears as thick rope on the miniature set. The log is cracked in two places, but remains as one solid piece and is in fine overall condition.

Dimensions: 102 cm x 11.5 cm x 11.5 cm (40" x 4 1/2" x 4 1/2")

£2,000-3,000



475. Rebel Wrist Communicator ΩΔ

STAR WARS: RETURN OF THE JEDI (1983)

A Rebel wrist communicator from Richard Marquand's *Star Wars: Return of the Jedi*. Rebel Alliance soldiers wore wrist communicators during the Battle of Endor.

The wrist communicator is made of vacuum-formed plastic with a stretchy tan-coloured nylon band that secures with Velcro. The strap shows annotation in marker that reads "Wrist Watch", "Rebel Foot Soldier #20" and "BH1014". "#20" indicated that it was the 20th communicator made as they were all numbered, and "BH" is a reference to Blue Harvest, the film's production title. There is another annotation written on the interior which indicates the direction the device should be worn. The lot shows minor wear to the paint due to production use and age, but is in very fine condition.

Dimensions: 8 cm x 10 cm x 5 cm (3" x 4" x 2")

£3,000-5,000



476. Jabba the Hutt Production Face Casting US**STAR WARS: RETURN OF THE JEDI (1983)**

A production casting of Jabba the Hutt's face made for Richard Marquand's *Star Wars: Return of the Jedi*. The appliance was one of the first test skins produced for the vile gangster, but was deemed too thick and dense a casting to be usable on the puppet. The film-used Jabba puppet was destroyed after filming and this is the only production casting of the character's face that exists.

The casting was used during production for 'slime tests' and was ultimately taken home by animatronics engineer John Coppinger, who sculpted the character for the film.

The eyes consist of vacuum-formed plastic covers over grey-coloured fibreglass inner eye forms. The Jabba skin resides on a bespoke fibreglass display form that was sculpted to support the foam in its proper position.

Jabba's face casting has undergone sympathetic restoration to some areas of the foam which have hardened due to age. The back of the skin has some areas that are backed with fabric to aid the preservation of the appliance. The skin has also been treated by hand with protective sealant. The lot remains in good condition.

Dimensions: 117 cm x 74 cm x 66 cm (46" x 29" x 26")

£15,000-20,000

**477. Jabba the Hutt Barge Gargoyle Ω****STAR WARS: RETURN OF THE JEDI (1983)**

A gargoyle from Jabba the Hutt's barge from Richard Marquand's *Star Wars: Return of the Jedi*. One-eyed gargoyle heads were affixed to Jabba's flying barge, and were also seen on his main platform within his palace.

The gargoyle head is made of fibreglass, with a metal ring attached inside its mouth. The figure is painted brown, with green highlights to resemble rusted metal. The knocker ring and setting are made of welded metal and are similarly painted to match the head.

The head is cast into a hat-shaped fibreglass bowl which was screwed into the larger set. Screw holes are present around the base, with the knocker-ring setting bolt protruding through the backside. The gargoyle shows wear due to use and age, with paint missing on the knocker ring as well as broken teeth, but remains in fair condition.

Dimensions: 35.5 cm x 35.5 cm x 33 cm (14" x 14" x 13")

£3,000-5,000



478. Blue Harvest Crew Cap Ω**STAR WARS: RETURN OF THE JEDI (1983)**

A "Blue Harvest" crew cap from the production of Richard Marquand's *Star Wars: Return of the Jedi*. This hat was custom-made by The Thinking Cap Co. and displays an embroidered "Blue Harvest" patch using the *Star Wars* font.

"Blue Harvest" was a fictitious title used by Lucasfilm to help disguise the fact it was shooting one of the most anticipated films of all time. The hat is made from grey fabric and includes an adjustable black plastic sizing band. Showing minor signs of wear due to age, the cap remains in very fine condition.

Dimensions: 18 cm x 25 cm x 10 cm (7" x 10 ½" x 4")

£1,000-1,500

**479. Sarlacc Tooth** Ω**STAR WARS: RETURN OF THE JEDI (1983)**

A sarlacc tooth from Richard Marquand's *Star Wars: Return of the Jedi*. Jabba the Hutt sentenced Luke Skywalker and his friends to die by being cast into the Great Pit of Carkoon, where the sarlacc would digest its victims over a thousand years. This tooth was part of the cavern in the sand, which served as the mouth of the dreaded sarlacc.

The tooth is made of foam with a thin urethane skin applied on top. The piece is painted in shades of tan and brown, giving it an earthy feel. The foam is rigid and some of the urethane and paint has cracked due to age, but the piece remains in very fine condition.

Dimensions: 30 cm x 5.5 cm x 5.5 cm (11 ¾" x 2 ¼" x 2 ¼")

£2,000-3,000

**480. C-3PO's (Anthony Daniels) Hands** Ω**STAR WARS: THE EMPIRE STRIKES BACK (1980);
STAR WARS: RETURN OF THE JEDI (1983)**

C-3PO's (Anthony Daniels) hands from Irvin Kershner's *Star Wars: The Empire Strikes Back* and Richard Marquand's *Star Wars: Return of the Jedi*. The C-3PO costumes were heavily revised following the production of *Star Wars: A New Hope*. As part of the overall upgrade, the hands were simplified, switching from their original vacuum-formed plastic construction to a one-piece construction in cast urethane, making them hardier, easier to fit and more straightforward to manufacture.

These one-piece gloves are cast in yellow urethane and feature detailed knuckles and ridges along the back of each hand. Plated screw detailing is fitted above the fingers, with metal rings around the finger joints and holes for securing additional detailing components, while square 'contact' detailing is sculpted into the palm. A press-stud fitting runs across each wrist to secure the glove in place. Two cuts are present on each hand — one running from the wrists to the palms, one at the rear of the thumbs — to allow easy fitting and removal. A faux-silver basecoat covers the hands, with painted cables running up the fingers. Accompanying the lot is a letter of authenticity from Anthony Daniels' son, Chris Kinnear.

Displaying minor signs of wear, the gloves have lost some of their reflective coating, revealing the base paint layers and tinted urethane beneath. The stud fitting on the right glove has broken down the middle. The urethane displays some scratches, though it remains supple and malleable, with minimal tearing.

Dimensions (each): 25 cm x 15 cm x 7 cm (10" x 6" x 2 ¾")

£20,000-30,000

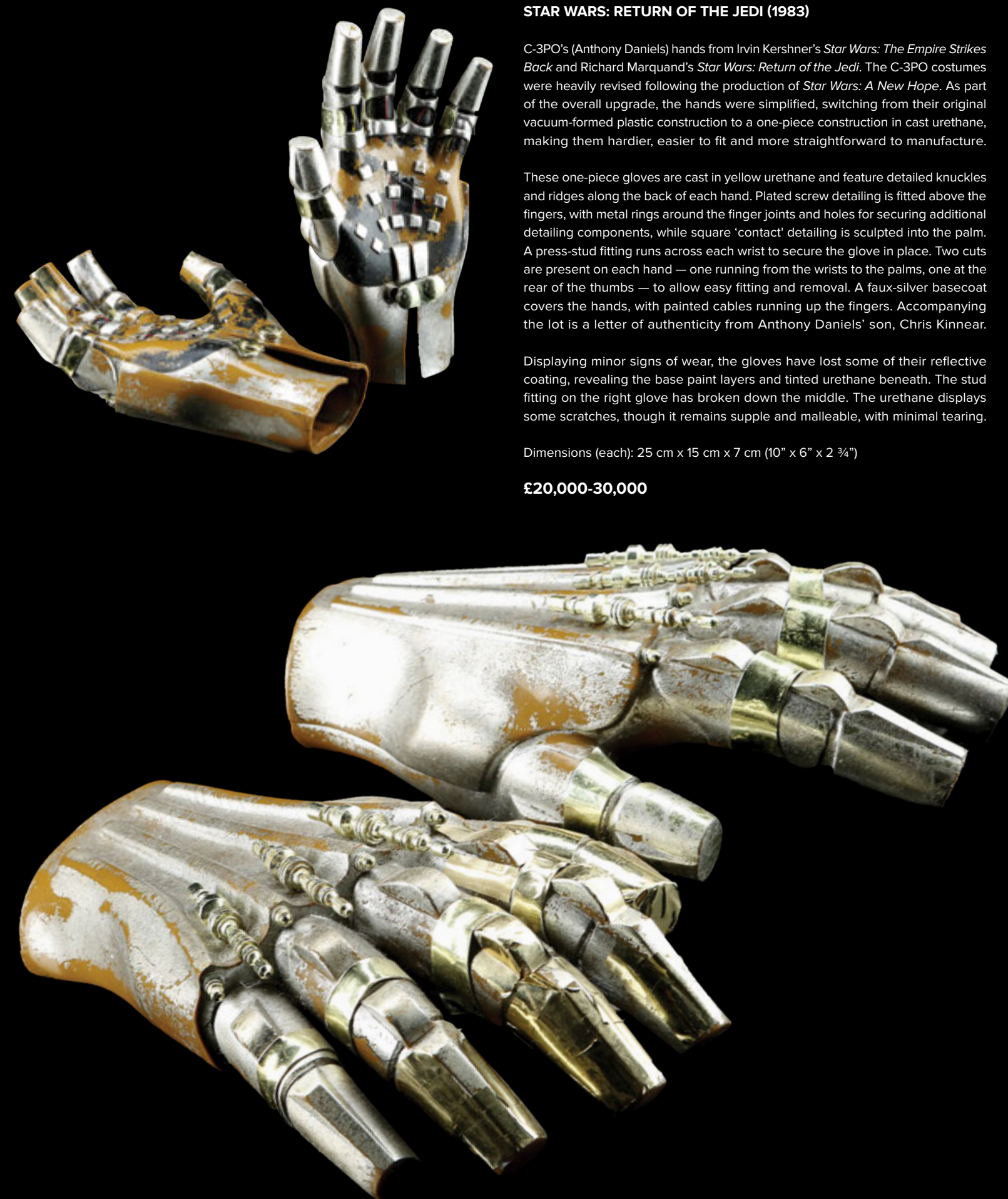

481. Crew Autographed Megaphone Ω

INDUSTRIAL LIGHT & MAGIC

A megaphone autographed by numerous key staff from Industrial Light & Magic. Issued as a parting gift to former ILM general manager Thomas G Smith, who oversaw visual effects for classics such as *Raiders of the Lost Ark*, *E.T. The Extra-Terrestrial*, *Star Wars: Return of the Jedi* and *Poltergeist*, the megaphone is signed by various effects artists and model makers, including Dave Carson, Dennis Muren, Ken Ralston, Lorne Peterson, Mike Fulmer, Mike McAlister, Norman Reynolds, Steve Gawley, and Tom St. Amand, among others. The cone-shaped megaphone is made of thick plastic with a metal grip and mouthpiece. The piece remains in very fine condition.

Dimensions: 66 cm x 27 cm x 27 cm (26" x 10 1/2" x 10 1/2")

£4,000-6,000

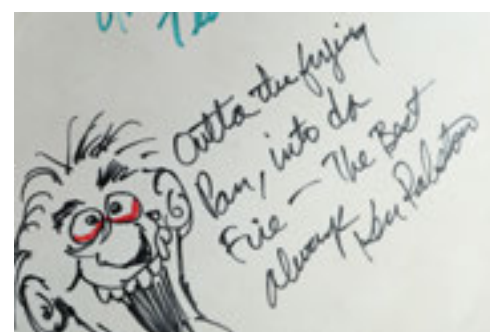

482. Apple Box Ω

INDUSTRIAL LIGHT & MAGIC

An apple box used by Industrial Light & Magic at its San Rafael, California facility. Apple boxes are commonly used on film sets as tools for propping up or supporting items. This piece is a plywood block that is painted black and features the stencilled words "ILM STAGE" in white on the top panel.

The box shows notable wear due to production use and age, with paint flaking and wood chips. The piece remains in fair condition.

Dimensions: 51cm x 30 cm x 10 cm (20" x 12" x 4")

£600-800

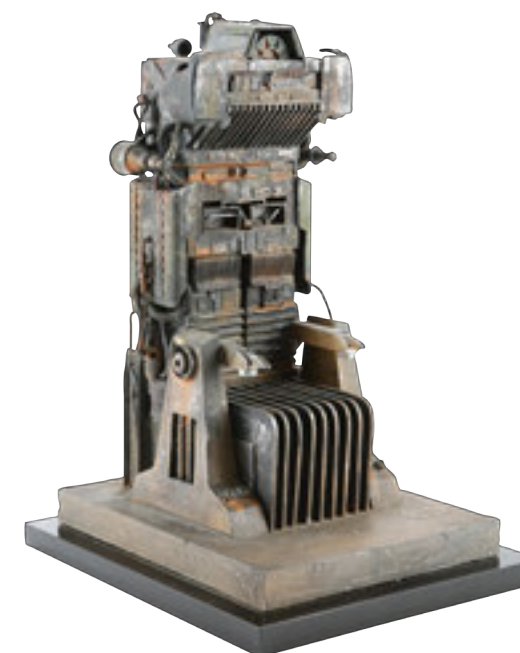

483. Terak's (Carel Struycken) Throne Maquette Ω

EWOKS: THE BATTLE FOR ENDOR (1985)

A maquette of Terak's (Carel Struycken) throne from Jim and Ken Wheat's *Star Wars* spin-off film *Ewoks: The Battle For Endor*. Terak was chief of the Marauders, a gang of pirates who crashed on the forest moon of Endor. Terak sat on a throne inside the castle built by the Marauders.

This makeshift throne maquette was made by Industrial Light & Magic and is constructed from multiple resin and plastic components. Notably, this piece is kit-bashed from components recognisable as belonging to a 74-Z speeder bike. It is painted to resemble rusting metal. The piece is presented on a custom-made acrylic base which has a note attached to the bottom. This note is addressed to Tom Smith, a producer of the film, and features a hand-drawn sketch of an Ewok by model maker Bill George, along with a thank you. The piece shows minimal wear and is in very fine overall condition.

Dimensions (on base): 20.5 cm x 16.5 cm x 28 cm (8" x 6 1/2" x 11")

£800-1,000

484. Cast-and-Crew Autographed Stormtrooper Helmet †Δ

STAR WARS TRILOGY (1977-83)

An autographed replica stormtrooper helmet from the original *Star Wars* trilogy. Made of white vacuum-formed plastic, the helmet displays a black rubber trim along the brow and neck, green acrylic lenses installed in the eye holes and various decals, including blue tube stripes on the cheeks.

The helmet displays 23 autographs in black marker by various cast and crew, including David Prowse, Kenny Baker, Jeremy Bulloch, Billy Dee Williams, producer Gary Kurtz and a collection of Stormtroopers. Minor marks and wear are present on the piece and some of the autographs have faded slightly. The lot comes presented on a display stand.

Dimensions (displayed): 40 cm x 40 cm x 40 cm (15 3/4" x 15 3/4" x 15 3/4")

£600-800

485. Ralph McQuarrie Hand-Drawn Illustration - Bespin Floating City Ruins Ω

THE ILLUSTRATED STAR WARS UNIVERSE (1995)

A Ralph McQuarrie hand-drawn illustration of the Tatooini skiff from author Kevin J. Anderson's 1995 book *The Illustrated Star Wars Universe*. This collection of new and re-purposed concept art from the original trilogy was compiled in order to focus on eight in-universe planets.

The sketch is rendered in pencil on paper. The image depicts two figures on a futuristic bike in the ruins of the Cloud City on Bespin. The lot shows minor wear to the paper, but remains in very fine condition.

Dimensions: 28 cm x 21.5 cm (11" x 8 1/2")

Please note this lot is sold without copyright, reproduction rights, licensing agreements or any other type of legal releases.

£2,000-3,000





486. Ralph McQuarrie Hand-Drawn Illustration — Hammerhead (Mamow Nadon) Ω

STAR WARS: THE MOS EISLEY CANTINA POP-UP BOOK (1995)

A Ralph McQuarrie hand-drawn illustration of Hammerhead (Mamow Nadon), made for the illustrated *Mos Eisley Cantina Pop-Up Book* released in 1995. McQuarrie served as the primary illustrator for this book. The image depicts the Ithorian Mamow Nadon, a botanist who was exiled to Tatooine from his home planet.

The sketch is rendered in pencil on thin vellum paper. McQuarrie created pieces such as this in order to transfer a drawing outline that would be the basis for a painting. A pinline borders the image and is meant to represent the edges of the book's page. The lot shows wear, including small holes that have been stabilised with clear tape. Additionally, tears are present at the bottom of the paper, and the left side exhibits wrinkling. Overall, this lot is in fair condition.

Dimensions: 35.5 cm x 30.5 cm (14" x 11")

Please note this lot is sold without copyright, reproduction rights, licensing agreements or any other type of legal releases.

£2,500-3,500

487. Ralph McQuarrie Hand-Drawn Illustration - Jabba's Palace Gate Concept Sketch Ω

THE ILLUSTRATED STAR WARS UNIVERSE (1995)

A Ralph McQuarrie hand-drawn illustration of a gate to Jabba's Palace from author Kevin J. Anderson's 1995 book *The Illustrated Star Wars Universe*. This collection of new and re-purposed concept art from the original trilogy was compiled in order to focus on eight in-universe planets.

The sketch is rendered in pencil on paper and is outlined with a red line. Additionally, a color test is applied at one corner. The image depicts a gate-style structure on a bridge with multiple figures walking beneath for scale. This design later influenced a set piece in *The Force Awakens*. McQuarrie's gate is clearly seen at the entrance for Niima Outpost on Jakku. The lot shows minor wear to the paper, but remains in very fine condition.

Dimensions: 28 cm x 21.5 cm (11" x 8 1/2")

Please note this lot is sold without copyright, reproduction rights, licensing agreements or any other type of legal releases.

£2,000-3,000

488. Promotional Prints of Rey and Finn, Stormtroopers and Kylo Ren M

STAR WARS: THE FORCE AWAKENS (2015)

A set of promotional prints from J.J. Abrams' *Star Wars: The Force Awakens*. These prints were part of the charity auction *Star Wars: Force For Change*, held in 2015 in support of UNICEF Kid Power. The lot consists of three prints showing images of Rey (Daisy Ridley), Finn (John Boyega), BB8, Kylo Ren (Adam Driver) and a group of First Order stormtroopers.

Each print is presented in a black card frame with the movie title artwork printed in yellow and white, and all three are numbered as 166 out of 286. Each print is in mint condition and a *Star Wars: Force For Change* certificate of authenticity is adhered to the back of the Stormtrooper print.

Dimensions (each): 28 cm x 43.5 cm x 0.2 cm (11" x 17 1/4" x 1/4")

£300-500



489. Miniature Helmets Crew Gift †Δ

ROGUE ONE: A STAR WARS STORY (2016)

A collection of miniature helmets given as gifts to crew who worked on Gareth Edwards' *Star Wars* prequel *Rogue One: A Star Wars Story*. The special set was gifted only to Heads of Departments and created by Propshop, the company behind many spectacular props and costume components.

battle-worn on-screen counterparts. They are presented in a row on a custom-made base finished with textured black paint and bearing a small plaque featuring the film's title. Also included is the original card shipping box with Propshop sticker.

Dimensions: 13 cm x 39 cm x 13 cm (5" x 15 1/4" x 5")

The trio consists of a Death Trooper, Stormtrooper and Shoretrooper helmet. They are cast in resin and have been hand-painted and decorated to match their

£800-1,200





490. Baze Malbus (Wen Jiang) Exhibition Costume Display †

STAR WARS: ROGUE ONE: A STAR WARS STORY (2016)

A Baze Malbus (Wen Jiang) exhibition costume display from Gareth Edwards' *Star Wars* prequel *Rogue One: A Star Wars Story*. The freelance assassin wore his attire as he accompanied his friend Chirrut Îmwe (Donnie Yen) and assisted the Rebels during the Battle of Scarif.

World Duty Free and The Walt Disney Company Ltd collaborated to promote the release of the film in late 2016 through a seven-week campaign which took place in Gatwick Airport's South Terminal. Central to the exhibition was a selection of replica lead character costumes, painstakingly created by the same production team who worked on the movie using original production reference. The costume consists of a beige cotton jumpsuit, several armour components mainly on the right side of the costume, a black cape, a white utility belt with adhered brown pouches, a pair of distressed gloves, black Chelsea boots and a barrel-shaped power pack. Finished in red, the resin neck piece features an off-white "V" logo on the front, five individual decorative cartridge-like sections and a black microphone device.

The costume is accompanied by a heavy power pack with its connecting long tube and Baze's heavy repeater cannon. The large blaster is made from cast resin and is finished in shades of faux-silver with red detailing in the middle.

Intentionally distressed for display purposes, the costume comes presented on a custom-made display with a plaque featuring the *Rogue One* title artwork and a description of the character's history.

Dimensions (displayed): 50 cm x 100 cm x 173 cm (19 ¾" x 39 ½" x 68 ¼"); (power pack): 49 cm x 36 cm x 33 cm (19 ¼" x 14 ¼" x 13"); (cord): 47 cm x 47 cm x 10 cm (18 ½" x 18 ½" x 4"); (blaster): 29 cm x 72 cm x 9 cm (11" x 28 ½" x 3 ½")

As this item is oversized it will require a specialist shipping service with additional costs. Please contact us prior to purchasing to request a quote.

£10,000 – 20,000



491. Bodhi Rook (Riz Ahmed) Exhibition Costume Display †

ROGUE ONE: A STAR WARS STORY (2016)

A Bodhi Rook (Riz Ahmed) exhibition costume display from Gareth Edwards' *Star Wars* prequel *Rogue One: A Star Wars Story*. The former Imperial pilot wore his costume throughout the film, adding the vest to his attire when he helped the Rebels during the Battle of Scarif.

World Duty Free and The Walt Disney Company Ltd collaborated to promote the release of the film in late 2016 through a seven-week campaign which took place in Gatwick Airport's South Terminal. Central to the exhibition was a selection of replica lead character costumes, painstakingly created by the same production team who worked on the movie using original production reference. The costume consists of transparent rubber goggles with a black elastic strap, distressed custom grey overalls, a brown survival vest and a pair of brown Chelsea boots. A circular plastic Imperial "cog" insignia decorates both sleeves of the overalls, with multiple faux-silver diagnostic cylinders and a resin comm pad on the left sleeve.

Featuring a zip fastening, the vest exhibits various pockets constructed from cotton, with an Imperial comm link finished in faux silver and several other matching components adhered to the garment. Minor intentional wear is present on the costume, including scratches on the goggles, applied discolouration and a small hole on the right sleeve. The costume is presented on a custom-made display with a plaque featuring the *Rogue One* title artwork and a description of the character's history.

Dimensions (displayed): 50 cm x 100 cm x 165 cm (19 ¾" x 39 ½" x 65")

As this item is oversized it will require a specialist shipping service with additional costs. Please contact us prior to purchasing to request a quote.

£10,000-20,000



492. Chirrut Îmwe (Donnie Yen) Exhibition Costume Display †

ROGUE ONE: A STAR WARS STORY (2016)

A Chirrut Îmwe (Donnie Yen) exhibition costume display from Gareth Edwards' *Star Wars* prequel *Rogue One: A Star Wars Story*. Chirrut wore his costume throughout the film, from his first appearance on the planet Jedha through to the Rebel assault during the Battle of Scarif.

World Duty Free and The Walt Disney Company Ltd collaborated to promote the release of the film in late 2016 through a seven-week campaign which took place in Gatwick Airport's South Terminal. Central to the exhibition was a selection of replica lead character costumes, painstakingly created by the same production team who worked on the movie using original production reference. The costume comprises a grey-blue wrap-over top, a cape-like piece draped over one shoulder, a white leather harness, a bracer with resin armour, a pair of grey trousers, a red skirt, a black woven asymmetric skirt with decorative red stripe and a pair of brown Chelsea boots. One half of the top is made from a suede-like fabric with decorative lines of yellow stitching, various pockets and padded sections.

The costume is accompanied by a staff made of fibreglass which has been finished to resemble the appearance of wood. Resin components finished in faux silver feature at the top end and along the grip. Minor wear is present on the costume, with the display base and the staff displaying an intentional split horizontal line along the middle. The costume is presented on a custom-made display with a plaque featuring the *Rogue One* title artwork and a description of the character's history.

Dimensions (display): 50 cm x 100 cm x 159 cm (19 ¾" x 39 ½" x 62 ¾");
(staff): 133 cm x 5 cm x 6 cm (52 ½" x 2" x 2 ½")

As this item is oversized it will require a specialist shipping service with additional costs. Please contact us prior to purchasing to request a quote.

£10,000-20,000



493. K-2SO Droid Exhibition Display †

ROGUE ONE: A STAR WARS STORY (2016)

A K-2SO droid exhibition display from Gareth Edwards' *Star Wars* prequel *Rogue One: A Star Wars Story*. Originally created for the Galactic Empire's armed forces, K-2SO (Alan Tudyk) was reprogrammed to assist the Rebel Alliance, before becoming co-pilot to Cassian Andor (Diego Luna). The security droid appeared throughout the film, sacrificing himself to save Cassian and Jyn Erso (Felicity Jones) during the Battle of Scarif.

World Duty Free and The Walt Disney Company Ltd collaborated to promote the release of the film in late 2016 with a seven-week campaign which took place in Gatwick Airport's South Terminal. The exhibition featured a selection of replica lead character props and costumes. These were created by the production team who worked on the movie using original production reference. The character was realised using CGI and motion capture in the film.

Inspired by unused designs by concept artist Ralph McQuarrie, K-2SO was originally intended to be a black protocol droid and the Imperial version of C-3PO. The final version of the droid took elements from previous designs in the original trilogy: the chest armour referenced the exterior of an AT-AT commander seen in *The Empire Strikes Back*; the triangular mouth resembled that of the RA-7 protocol droids; and the head shape was influenced by stormtrooper helmets.

Constructed from a combination of fibreglass, resin and metal, the droid consists of a tall skeletal figure with human-like limbs and mechanical components throughout. The head of the droid displays two rounded acrylic eyes and a cut-out section adorns the front of the torso. Finished in dark shades of grey, K-2SO has strips of yellow around his shoulders and legs, and white Imperial insignias decorate both shoulders.

The K-2SO droid displays minor paint wear and faux-silver marks, and is mounted on a custom-made display with a plaque featuring the *Rogue One* title artwork and a description of the character's history.

Dimensions (displayed): 75 cm x 100 cm x 216 cm (29 1/2" x 39 1/2" x 85 1/4")

As this item is oversized it will require a specialist shipping service with additional costs. Please contact us prior to purchasing to request a quote.

£15,000-25,000



494. Captain Cassian Andor (Diego Luna) Exhibition Costume Display †

ROGUE ONE: A STAR WARS STORY (2016)

A Captain Cassian Andor (Diego Luna) exhibition costume display from Gareth Edwards' *Star Wars* prequel *Rogue One: A Star Wars Story*. The Rebel Alliance intelligence officer wore his costume throughout the film as he led the operation to steal the plans for the Death Star from the planet Scarif, alongside Jyn Erso (Felicity Jones).

World Duty Free and The Walt Disney Company Ltd collaborated to promote the release of the film in late 2016 through a seven-week campaign which took place in Gatwick Airport's South Terminal. Central to the exhibition was a selection of replica lead character costumes, painstakingly created by the same production team who worked on the movie using original production reference. The costume consists of a brown cotton jacket, a beige top with an overlapping section at the front, khaki combat trousers, a khaki utility belt, a black leather holster and a pair of brown boots.

Decorative lines of stitching decorate the jacket with light-coloured strip detailing running down both sleeves. Two captain insignias finished in faux silver are adhered to the front of the jacket, highlighting Cassian's rank within the Rebel Alliance. A zip runs down the front and the cuffs feature Velcro. The trousers have multiple pockets and the belt features removable plastic energy pellets, finished in faux silver to replicate the appearance of metal.

Made of plastic, a replica version of a Rebel Alliance A280-CFE blaster is housed within the holster. Based on the receiver of an AR-15 rifle, the weapon is finished in dark grey with faux-silver highlights. The blaster displays minor glue residue and paint wear. Showing only minor wear throughout, the costume is presented on a custom-made display with a plaque featuring the *Rogue One* title artwork and a description of the character's history.

Dimensions (displayed): 50 cm x 100 cm x 167 cm (19 ¾" x 39 ½" x 65 ¾")

As this item is oversized it will require a specialist shipping service with additional costs. Please contact us prior to purchasing to request a quote

£15,000-25,000

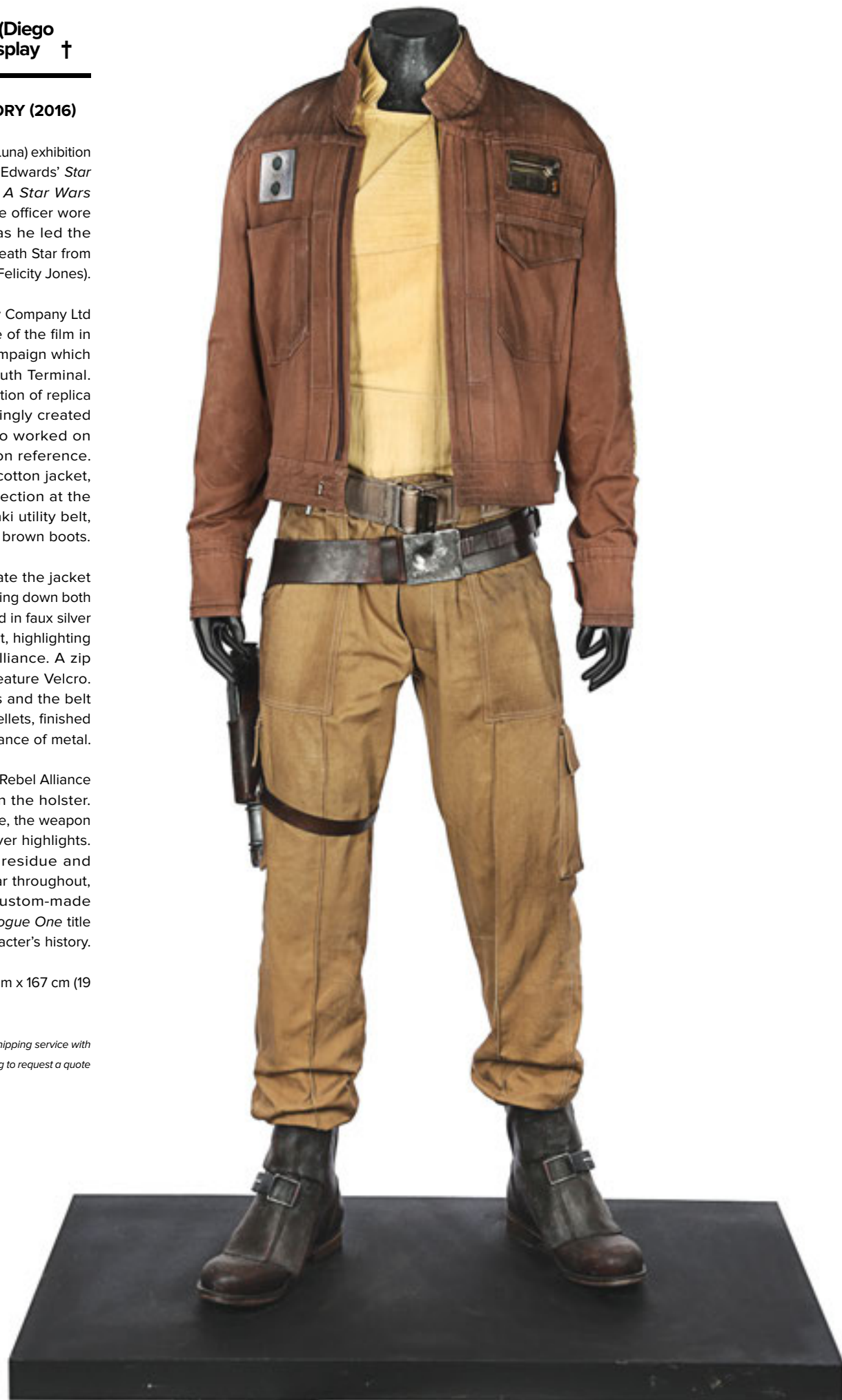

495. Jyn Erso (Felicity Jones) Exhibition Costume Display †

ROGUE ONE: A STAR WARS STORY (2016)

A Jyn Erso (Felicity Jones) exhibition costume display from Gareth Edwards' *Star Wars* prequel *Rogue One: A Star Wars Story*. Jyn wore her costume throughout the majority of the film, adding the scarf to her attire when she visited the planet Jedha with Captain Cassian Andor (Diego Luna) and K-2SO (Alan Tudyk).

World Duty Free and The Walt Disney Company Ltd collaborated to promote the release of the film in late 2016 through a seven-week campaign which took place in Gatwick Airport's South Terminal. Central to the exhibition was a selection of replica lead character costumes, painstakingly created by the same production team who worked on the movie using original production reference.

The costume consists of a grey scarf, a brown utility vest, a bomber-style jacket, a grey top with an overlapping collar, a pair of brown leather fingerless gloves, a pair of loose-fitting black trousers, a belt with a brown leather holster and a pair of brown boots.

Light-coloured strip detailing runs down both sleeves of the khaki jacket and multiple lines of stitching adorn the garment. Padded at the back, the brown vest features an elasticated waistband, a black tubing strip with a hook running down the front and a decorative faux-silver Rebel Alliance badge. Multiple pintucks feature on the bottom half of the trousers and several stitches have been used to keep the costume's components in place.

Housed within the holster is a stunt version of a Rebel Alliance A180 pistol. Finished in black and faux silver, the weapon is based on a Luger pistol and is made of plastic. A resin tonfa baton is clipped onto the holster and is finished in shades of dark grey.

Showing minor wear, the costume is presented on a custom-made display with a plaque featuring the *Rogue One* title artwork and a description of the character's history.

Dimensions (displayed): 50 cm x 100 cm x 156 cm
(19 ¾" x 39 ½" x 61 ½")

As this item is oversized it will require a specialist shipping service with additional costs. Please contact us prior to purchasing to request a quote.

£15,000-25,000

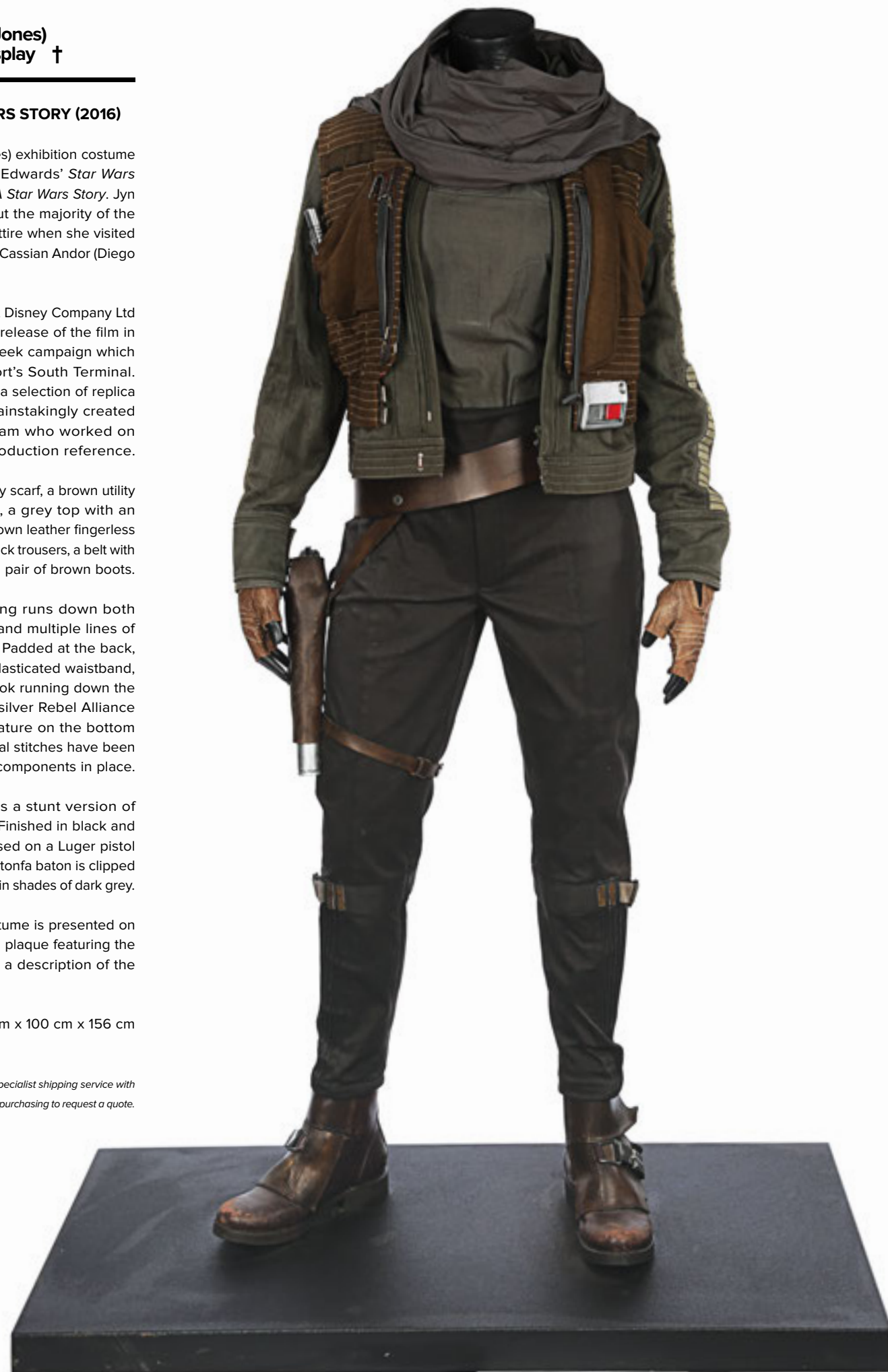

496. First Order Stormtrooper Helmet

STAR WARS: THE LAST JEDI (2017)

A First Order stormtrooper helmet from Rian Johnson's *Star Wars: The Last Jedi*. First Order stormtroopers wore their helmets throughout the film, aboard Supreme Leader Snoke's (Andy Serkis) flagship, the Supremacy, which served as the headquarters of the First Order. This helmet was donated by Lucasfilm, via costume designer Michael Kaplan, to the UK children's charity NSPCC.

Director Rian Johnson decided to subtly modify aspects of the helmet to produce a more threatening appearance. The appearance of First Order stormtroopers in *The Last Jedi* was heavily influenced by the design of the original trilogy's Imperial stormtroopers and differs slightly from the uniform seen in *The Force Awakens*. Changes included the shape of the nose ridge, a thinner mouth and added 'teeth' detailing.

The main body of the helmet is cast in polyurethane, a denser and more battle-appropriate material than the vacuum-formed ABS plastic used to make the original stormtrooper helmets, which were prone to cracking and breakages through use. Multiple vents run down both sides, and the left side of the helmet displays a fitted

metal aerator. Clips feature on the dome of the helmet, and several parts of the piece are finished in black, including the acrylic bubble lenses fitted in the eye recesses, the brow line, the mesh grill on the mouth and the prominent teeth detailing.

The inside of the helmet displays a sticker reading "B8-37", the number "37" written in black marker, and several pieces of foam that have been adhered for comfort during wear. The helmet's interior has been signed by Michael Kaplan.

The lot displays signs of production use, including minor wear and marks, notably on the underside of the neck. Glue residue is present on the inside of the aerator. The lot is accompanied by a letter of authenticity on Lucasfilm stationery, signed by Michael Kaplan. Dimensions: 32 cm x 27 cm x 30 cm (12 3/4" x 10 3/4" x 12")

All hammer price proceeds from this item are being donated to the NSPCC. This lot is zero rated for VAT purposes.

£30,000 – 50,000



In aid of

NSPCC

The NSPCC is the UK's leading children's charity fighting to end child abuse and keep children safe. They protect children at risk, help children who've been abused to rebuild their lives, and work to find the best ways of preventing child abuse from ever happening. So, whether a child needs a helping hand, a parent is finding it tough, a law needs to change, or government needs to do more, the NSPCC will be there – fighting for every childhood. We can all play a part in keeping children safe. Abuse changes childhood. But so can we. To find out more, visit nspcc.org.uk





497. SFX Crew Jacket M

498. Gold-Plated Han Solo Millennium Falcon Lucky Dice Crew Gift and T-Shirt ⚡

499. Daniel Jackson's (Michael Shanks) Uniform M

500. Samantha Carter's (Amanda Tapping) Uniform and Dog Tag M

501. Teal'c's (Christopher Judge) Uniform M

502. Jack O'Neill's (Richard Dean Anderson) Uniform M

STAR WARS: THE LAST JEDI (2017)

A special-effects crew jacket from Rian Johnson's *Star Wars: The Last Jedi*. Jackets were gifted to members of the special-effects department who worked on the production.

Made from navy blue polyester, the quilted jacket displays the embroidered text "VIII" in yellow on the right breast, with "SFX Crew 2016" in white below. A zip runs down the front and the garment features two pockets with metal popper fastenings. Labelled as a size medium, the jacket comes with its original tags attached to the inside neck loop, with light marks present on the right sleeve.

£200-300

SOLO: A STAR WARS STORY (2018)

A Han Solo Millennium Falcon lucky dice crew gift and T-shirt from *Solo: A Star Wars Story*. Gifted to the heads of department, the crew gift consists of a short chain with two gold-plated dice featuring decorative cast-in symbols. The gift comes presented on a grey stand, in a plastic, foam-lined playing-card style box.

Accompanying the crew gift is a blue cotton T-shirt. The garment features the film's title with the text "2 EFX Crew 2017" on the right sleeve, the names of various effects-team crew members and an image of Han Solo's famous starship, printed in several colours on the back. The shirt is marked as a size large and the crew gift box displays minor wear. Dimensions (box on stand): 8 cm x 7 cm x 11 cm (3 ¼" x 2 ¾" x 4 ½")

£600-800

STARGATE SG-1 (TV SERIES 1997-2007)

Daniel Jackson's (Michael Shanks) SG-1 uniform from the sci-fi television show *Stargate SG-1*. The team's civilian member wore his U.S. Air Force clothing throughout the series, both on off-world missions and within the top-secret Earth base.

The uniform consists of a matching blue jacket (labelled "Daniel 03/03") and trousers, with a black t-shirt labelled "Daniel" within. The jacket includes two replica mission patches to complete the aesthetic.

£600-800

STARGATE SG-1 (TV SERIES 1997-2007)

Samantha Carter's (Amanda Tapping) SG-1 uniform and dog tag from the sci-fi television show *Stargate SG-1*. Major Carter wore her U.S. Air Force clothing throughout the series, both on off-world missions and within the top-secret Earth base.

The uniform consists of a green zip-up jacket with black nylon lining, ribbed cuffs and collar, a pair of matching trousers and a black vest top. The trousers include a handwritten label reading "CARTER 5/05 P", the top is sized "S" and the jacket is accompanied by two replica Velcro-backed mission patches to complete the aesthetic. Also included is a single metal dog tag stamped with Carter's information, hung from a short ball-link chain.

£600-800

STARGATE SG-1 (TV SERIES 1997-2007)

Teal'c's (Christopher Judge) SG-1 uniform from the sci-fi television show *Stargate SG-1*. The Jaffa warrior wore his U.S. Air Force clothing throughout the series, both on off-world missions and within the top-secret Earth base.

The outfit consists of a desert camouflage zip-up jacket, a pair of matching trousers and a brown T-shirt. The jacket, trousers and T-shirt include handwritten labels reading "TEAL'C", "Teal'c" and "Teal'c SGX L" respectively. The jacket includes a wardrobe tag featuring the character's name, with two replica Velcro-backed mission patches to complete the aesthetic. The left jacket cuff has a small hole present from production use.

£600-800

STARGATE SG-1 (TV SERIES 1997-2007)

Jack O'Neill's (Richard Dean Anderson) SG-1 uniform from the sci-fi television show *Stargate SG-1*. Colonel O'Neill wore his U.S. Air Force clothing throughout the series, both on off-world missions and within the top-secret Earth base.

The uniform consists of a green zip-up jacket with ribbed cuffs and collar, a pair of matching trousers and a black T-shirt. There are handwritten labels in each component, reading "O'Neill", "RDA" and "O'NEILL" respectively. The jacket includes two Velcro-backed replica mission patches to complete the aesthetic.

£800-1,200

503. Light-Up Asgard Stone M**STARGATE SG-1 (TV SERIES 1997 - 2007)**

A light-up Asgard stone from the sci-fi television show *Stargate SG-1*. Asgard stones were used by the Asgard and the Tau'ri in multiple episodes of the series, to retrieve information when placed on a console in a specific location.

The stone is made of plastic with an iridescent white finish. Faux-gold Asgard symbols decorate the bottom edge and the back features a white felt piece. Internal LED lights illuminate the stone and are activated by a small hidden button on the back. The stone displays minor wear to the symbols, a mark on the outer rim and the felt has begun to peel away. The lot is accompanied by a studio certificate of authenticity. Dimensions: 8.5 cm x 6.5 cm x 4 cm (3 1/2" x 2 3/4" x 1 3/4")

As this item contains electronic components, every effort has been made to describe them accurately. However, no guarantee or warranty is made as to functionality, lifespan or safety of those components. It is entirely incumbent on the new owner to satisfy themselves as to their safe use and maintenance.

£600-800**504. Ra's (Jay Williams) Mask Ω****STARGATE SG-1 (TV SERIES, 1997 - 2007)**

Ra's (Jay Williams) mask from the sci-fi television series *Stargate SG-1*. This mask was made for Ra's appearance in the finale of the show's eighth season. Ra wore his mask after SG-1 traveled back in time and created an alternate timeline.

This large mask is produced from fibreglass. The exterior of the mask features intricate designs and it is painted to look as though it is made of bronze, complete with portions of faux oxidation. The mask is also ornamented with reflected lenses and extended earrings that extend with the piece's long headdress.

A helmet is present at the interior of the mask, enabling the large piece to be worn snugly on the performer's head. Additionally, a urethane collar is included. This collar is painted with the same colors as the mask and hides the wearer's neck when worn. The lot has undergone sympathetic restoration to the face, which was damaged following the production, but remains in very fine overall condition.

Dimensions (mask): 61 cm x 56 cm x 84 cm (24" x 22" x 33");
 (collar): 20.5 cm x 15 cm x 13 cm (8" x 6" x 5")

£3,000-5,000**505. Zat Gun M****STARGATE SG-1 (TV SERIES 1997 - 2007)**

A Zat gun from the sci-fi television show *Stargate SG-1*. Zat guns were used by the Jaffa, Tok'ra and the SG-1 team in multiple episodes throughout the series.

Made of dense rubber, the weapon is shaped like a serpent and comes fixed in an open state. The gun has been finished in black with green accents and the lower end of the piece is finished in purple. Cast-in line detailing features all over and pieces of thin black rubber have been applied to cover hinges. The Zat gun shows wear to the paintwork and damage to one side, exposing the core of the piece. This lot is accompanied by a studio certificate of authenticity.

Dimensions: 28 cm x 8 cm x 18 cm (11" x 3 1/4" x 7 1/4")

£800-1,200**506. SFX Light-Up Replicator Disruptor M****STARGATE SG-1 (TV SERIES, 1997 - 2007)**

A special effects light-up Replicator Disruptor from the sci-fi television show *Stargate SG-1*. Created by Colonel Jack O'Neill (Richard Dean Anderson), the weapon was used in multiple episodes to sever communication between the advanced robot species known as the Replicators.

The majority of the disruptor is constructed from resin, with pieces of foam adhered to the interior. Finished in shades of blue and grey, with metallic paint used for detailing, the front panel of the weapon displays circuitry-style patterns. The back displays an opening which allows its user to insert their hand and grab a handle within. Housing internal electronics, it features two switches that illuminate two spirals situated behind the front piece, and five sections on the front panel. The weapon shows minor paint wear from use on production and is presented on a display base.

Dimensions (displayed): 48 cm x 35 cm x 45 cm
 (19" x 13 3/4" x 17 3/4")

This item contains electronic components. While every effort has been made to describe them accurately, no guarantee or warranty is made as to the functionality, lifespan or safety of those components. It is entirely incumbent on the new owner to satisfy themselves as to their safe use and maintenance.

£3,000-5,000



507. Merlin's (Matthew Walker) Light-Up Staff M

STARGATE SG-1 (TV SERIES 1997 - 2007)

Merlin's (Matthew Walker) light-up staff from the sci-fi television show *Stargate SG-1*. Merlin carried his staff in multiple episodes throughout the ninth and 10th series as he created the anti-Orl weapon known as the Sangraal.

The staff is made from a combination of wood and cast resin, finished in pale blue paint. Shades of blue and purple have been used to detail the decorative pattern on the top section, and the head of the staff features an encased blue sphere made of resin.

Powered by two AA batteries within the staff, internal lights illuminate the sphere when the top section is screwed on securely. The lot displays minor scuff marks from use on production and additional paint wear, most noticeable on the head of the staff. The piece is accompanied by a studio certificate of authenticity. Dimensions: 184 cm x 7 cm x 7 cm (72 1/2" x 2 3/4" x 2 3/4")

As this item contains electronic components, every effort has been made to describe them accurately. However, no guarantee or warranty is made as to functionality, lifespan or safety of those components. It is entirely incumbent on the new owner to satisfy themselves as to their safe use and maintenance.

£2,000-3,000



508. Kara'Kesh Ribbon Device Ω

STARGATE SG-1 (TV SERIES, 1997 - 2007)

A Kara'Kesh ribbon device from the sci-fi television series *Stargate SG-1*. Used most frequently by Goa'uld Underlords, the Kara'Kesh was worn on the left hand and was a multi-functional weapon capable of projecting kinetic energy, as well as shielding against attacks.

The device comprises a series of aluminium finger tips and rings that attach via spiral wire to a clear acrylic gem located at the palm of the hand, with a faux crystal encased on the back of the hand. The palm gem is housed in an aluminium casing that spirals down the forearm like a ribbon. The prop features a battery door hidden behind the palm gem, and includes an on/off switch at the base of the forearm ribbon. Also included is a battery powered remote control for the prop. The piece shows minor scratches to the paint, but remains in very fine condition. Dimensions: 39 cm x 20 cm x 13 cm (15" x 8" x 5")

As this item contains electronic components, every effort has been made to describe them accurately. However, no guarantee or warranty is made as to the functionality, lifespan or safety of those components. It is entirely incumbent on the new owner to satisfy themselves as to their safe use and maintenance.

£4,000-6,000



509. Miniature Death Glider M

STARGATE SG-1 (TV SERIES 1997-2007)

A model miniature Death Glider from the sci-fi television show *Stargate SG-1*. The Goa'uld used their distinctive ships throughout the series, which were capable of flying in both space and planetary atmospheres. The model screen matches to the Season 2 opening episode 'The Serpent's Lair', SG-1 and Bra'tac escape Apophis' ship in two gliders that come under attack, sustaining heavy damage.

The glider is constructed from a lightweight expanding rigid foam covered in a rigid skin, assembled in three parts which form the body and heavily curved wings. The cockpit, made from resin and clear acrylic, contains a seat and hand-painted controls. Earlier paint marks suggest this particular cockpit replaced an earlier canopy. Below the wings are two resin laser cannons.

The surface is painted metallic blue and purple, and etched with curved, gold-painted lines. There are assorted battle-damage marks representing laser blasts, and a thin layer of grey paint has been applied to resemble smoke and burn damage. The ship is in good condition, with small chips to the paint and hot glue residue where it has been assembled. Dimensions: 59 cm x 103 cm x 26 cm (23 1/2" x 40 1/4" x 10 1/2")

£6,000-£8,000

510. Ronon's (Jason Momoa) Sword M**STARGATE: ATLANTIS (TV SERIES 2004 - 2009)**

Ronon's (Jason Momoa) sword from the sci-fi television show *Stargate: Atlantis*. Ronon carried his sword in multiple episodes throughout the series, notably in the fifth season episode 'Broken Ties', when Ronon is captured by Tyre (Mark Dacascos) and transformed into a Wraith worshipper.

Custom-made for the production, the sword features an asymmetrical aluminium blade with a cut-out design. Displaying a textured surface, the blade has been finished in faux-silver paint with shades of blue applied. The weapon's grip is made of resin and has been finished in shades of brown and detailed to replicate the appearance of bone. Strips of tan leather are wrapped around the grip. Intentionally distressed for the production, the sword displays minor scuff marks and paint wear, and slight discolouration is present on the leather. The lot is accompanied by a studio certificate of authenticity.

Dimensions: 81 cm x 15 cm x 5 cm (32" x 6" x 2")

£2,000-3,000

**511. Wraith Stunner Pistol and Holster M****STARGATE: ATLANTIS (TV 2004 - 2009)**

A Wraith pistol and holster from the sci-fi television show *Stargate: Atlantis*. The Wraith, a vampiric species that harvest and feed on the life force of other beings, carried pistols from the second season of the show, as an alternative to their large rifle counterpart.

The stunner is cast in hard rubber with a bio-mechanical-style design, decorated with shades of blue and brass paint. At the centre of each side is a translucent yellow window which originally lit up via a switch below the barrel; however, this does not currently function. The pistol sits inside a holster made of leather and rubber, painted blue and grey with metal fasteners and leather straps. The weapon has light wear to the paint, and the metal components of the holster display light tarnishing.

Dimensions (holstered): 38 cm x 20 cm x 8 cm

This item contains electronic components. While every effort has been made to describe them accurately, no guarantee or warranty is made as to the functionality, lifespan or safety of those components. It is entirely incumbent on the new owner to satisfy themselves as to their safe use and maintenance.

£3,000-5,000

**512. Thor Hero Animatronic Puppet M****STARGATE: ATLANTIS (TV SERIES 2004 - 2009)**

A Thor hero animatronic puppet from the sci-fi television show *Stargate: Atlantis*. The advanced race led by Supreme Commander Thor featured in the show's later seasons. This version of the puppet was the final one created by the special-effects team and was used to portray Thor and several other Asgard.

The piece has green / brown silicone skin, with shades of blue and red applied to create vein detailing and cast-in lines, highlighting the species' skin texture. Two black plastic eyes, a set of visible plastic teeth and a faux-gold plated emblem with blue plastic jewels adorn the alien's face.

The puppet displays long, moveable limbs with plastic nails applied. Housed inside is a metal skeleton which contains an array of cables, wires and controls to work its functional limbs. Both elbow joints display a lever which features an incorporated bicycle brake cable and a handle which, when pressed, causes the wrist to bend. Mounted onto a metal pole, the back of the puppet displays an opening with popper and hook-and-eye fastenings, with wires and plastic cables running from the rear, towards the base.

One of the puppet's wrists does not function properly when the handle is pressed and the silicone displays very minor wear. The animatronic puppet comes displayed on a black base which shows minor scratches. The lot is accompanied by a studio certificate of authenticity.

Dimensions: 46 cm x 60 cm x 138 cm (18 1/4" x 23 3/4" x 54 1/2")

This item contains electronic and mechanical components. While every effort is made to describe them accurately, no guarantee or warranty is made as to the functionality, lifespan or safety of those components. It is entirely incumbent on the new owner to satisfy themselves as to their safe use and maintenance.

£6,000-8,000





513. Ronald Greer's (Jamil Walker Smith) Ancient Spacesuit M

SGU STARGATE UNIVERSE (TV SERIES, 2009 - 2011)

Ronald Greer's (Jamil Walker Smith) Ancient spacesuit from the sci-fi series *SGU Stargate Universe*. Sergeant Ronald Greer wore his spacesuit for extra-vehicular activity in various episodes, notably when he and Young (Louis Ferreira) avoided the lockdown during the mutiny aboard Destiny and opened the door for the military during the episode titled "Divided".

The costume consists of a helmet; a quilted faux-silver fabric undersuit; a large back plate with integrated equipment detailing; raised geometric shoulder pieces; layered armour plating covering the majority of the body; a ridged Velcro-fastened belt; and a pair of thick boots. Various pipes connect to a breathing apparatus located beneath a transparent visor on the helmet. The soft torso armour underneath the plating is made of rubber and decorated with raised patterns. Green paint has been used to highlight certain components on the top layer of the chest armour. The suit incorporates electronics which illuminate multiple parts of the armour and helmet, and is finished in varying metallic shades. It shows minor wear and is presented on a custom-made display.

Dimensions (displayed): 39 cm x 72 cm x 192 cm (15 ½" x 28 ½" x 75 ¾")

As this item contains electronic components, every effort has been made to describe them accurately. However, no guarantee or warranty is made as to the functionality, lifespan or safety of those components. It is entirely incumbent on the new owner to satisfy themselves as to their safe use and maintenance.

£3,000-5,000

514. Battle-Damaged Federation Corvette Transport Model Miniature M

STARSHIP TROOPERS (1997)

A battle-damaged Federation Corvette transport model miniature spaceship from Paul Verhoeven's sci-fi action film *Starship Troopers*. The cornerstone of the Federation fleet, UCF Corvettes came under heavy attack during the failed invasion of Klendathu. Upon returning to the battlestation Ticonderoga, the full extent of the destruction wrought upon the fleet by the alien "arachnids" was revealed.

Constructed by Sony Pictures Imageworks' Thunderstone model shop, this highly detailed mid-size miniature is made from cast resin components, with additional resin and styrene detailing to bring the engine nacelles, communications tower, bridge, gun turrets and fighter-deck scaffolds to life. Fibre-optic strands are still present; these illuminate 'windows' when lit. Plasma damage is applied to the hull of the vessel, with burned bulkheads revealing open decks and compartments. Additional burn marks are hand-painted on the hull in purple, marring the battleship's grey finish.

The model includes two interchangeable hull sections which allowed the ship to be used several times as different vessels during the Ticonderoga sequences. A support beam is fixed to the base of the ship, where it was likely mounted during production, and sits on a custom-made display stand.

Dimensions (displayed): 30 cm x 86 cm x 38 cm (11" x 34" x 15")

This item contains electronic components. While every effort is made to describe them accurately, no guarantee or warranty is made as to the functionality, lifespan or safety of those components. It is entirely incumbent on the new owner to satisfy themselves as to their safe use and maintenance.

£3,000-5,000

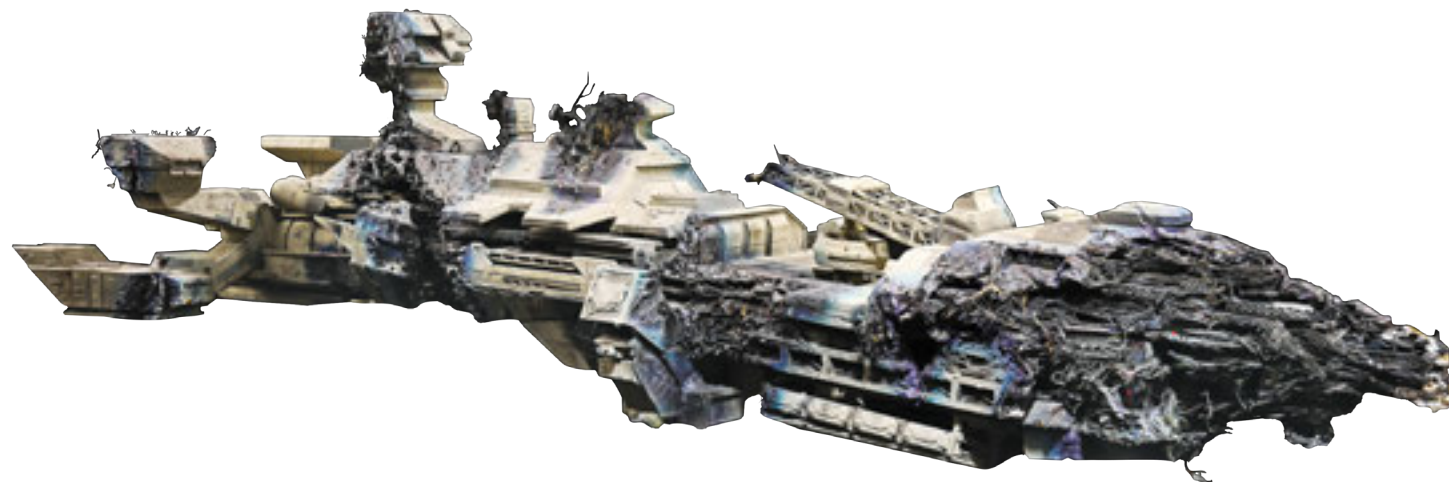

515. Jusef Sardu's (Robert Maillet) Master Transformation Costume Ω

THE STRAIN (TV SERIES, 2014 - 2017)

Jusef Sardu's (Robert Maillet) Master transformation costume from Guillermo del Toro and Chuck Hogan's horror series *The Strain*. The Master used Jusef Sardu, a Polish man with gigantism, as a host.

This imposing costume was designed by Academy Award®-winning costume designer Luis Sequeira, and consists of a large cloak, an undercoat, a vest, a tunic and a pair of boots. The large cloak is made of hand-dyed and shredded fabrics that are designed to make it look tattered and worn, with thick ropes also hanging from it. The necklace is produced from resin pieces cast in the shape of small pieces of bone, painted and coated in certain places with dried blood. Attached to the necklace is a tag marked, "Young Master". A shirt, worn under the vest, and an ornate velvet undercoat complete the costume. Each boot is a size 11.5 (US) and is made from leather, and each garment is marked as being a stunt piece. The costume shows intentional signs of wear and is in very fine condition.

£1,500-2,500

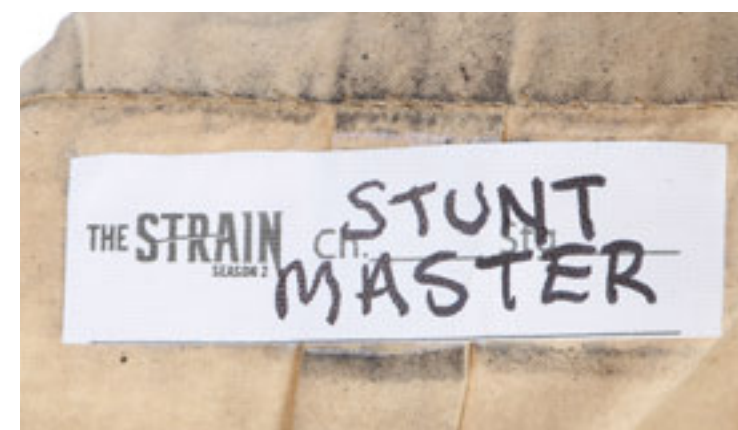

516. Occido Lumen Stunt Book Ω

THE STRAIN (TV SERIES, 2014 - 2017)

A stunt Occido Lumen book from Guillermo del Toro and Chuck Hogan's horror series, *The Strain*. Introduced in the second season, the Occido Lumen was a key artefact in the series, an ancient text which held the key to killing the Master (Robin Atkin Downes), and thereby end the vampire uprising.

This stunt version is made of soft foam and is painted faux silver to mimic the pure silver construction of the fictional book. The cover and spine display elaborate cast-in symbols and extravagant iconography. The foam remains soft, but the paint is flaking in numerous areas due to production use and age. However, the prop remains in good overall condition.

Dimensions: 26 cm x 32 cm x 7 cm (10 ¼" x 12 ¾" x 2 ¾")

£1,500-2,500

517. Production Paperwork Archive M

STRAW DOGS (1971)

An phenomenal archive of production paperwork from the Sam Peckinpah thriller *Straw Dogs*. This extensive collection of documents covers the entire eight month production complete with three shooting scripts, seven folders containing daily filming reports, hundreds of memos, letters, contracts, call sheets and telexes, and countless additional loose pages of working documents.

Much of the communication is from legendary director Sam Peckinpah, and many of the memos are signed or initialed. Perhaps most interesting is a letter from the director to producer Dan Melnick regarding Susan George's reluctance to appear in the infamous assault scene and the legal ramifications therein. It was this shocking sequence which has given *Straw Dogs* its notorious reputation.

This fascinating archive remains in very good condition, displaying signs of natural wear from use on the production, with some additional wear from use and time spent in storage. Dimensions: 52 cm x 38 cm x 20 cm (20 1/2" x 15" x 8")

£800-1,200



518. Christopher Reeve Autographed Photograph †Δ

SUPERMAN (1978)

An autographed photograph of Christopher Reeve from the promotion of Richard Donner's 1978 superhero film *Superman*. This arresting 8" x 10" black-and-white publicity still depicts Reeve in full costume as Superman, striking a strong pose on the parapet of a building against a New York cityscape, his cape flowing in the breeze.

It is autographed in blue ink, "To Steve - Yours, Christopher Reeve" at the top left corner. On the rear, "87/7" is handwritten in pencil. The photograph shows very minor age-related yellowing and wear around the edges. Dimensions: 25 cm x 21 cm (10" x 8 1/4")

£300-500



519. Daily Planet "Twin Nuclear Missiles Test Confirmed" Newspaper Front Page M

SUPERMAN (1978)

A *Daily Planet* "Twin Nuclear Missiles Test Confirmed" newspaper front page from Richard Donner's superhero film *Superman*. Lex Luthor (Gene Hackman) was handed a newspaper featuring this headline by Otis (Ned Beatty) and bragged to Miss Teschmacher (Valerie Perrine) that he would execute the greatest real-estate swindle in history.

Printed on newspaper stock, the single-sided front cover features the *Daily Planet* logo at the top with the headlines "Twin Nuclear Missiles Test Confirmed" and "Live Warheads to be Used" in bold. Several articles surround a black-and-white image of a missile. The newspaper shows signs of production use, including light wear to the edges of the page and minor discoloration.

Dimensions: 58 cm x 42.5 cm (23" x 16 3/4")

£400-600



520. Daily Planet Envelope, Production Call Sheet, and Behind-the-Scenes Photographs Ω

SUPERMAN (1978) / SUPERMAN II (1980)

A Daily Planet envelope, production call sheet, and behind-the-scenes photographs from Richard Donner's superhero film *Superman* and its sequel, Richard Lester's *Superman II*. The envelope is made of paper and features the Daily Planet newspaper logo printed at the upper left corner. The call sheet is printed on US legal paper, dated 28th July 1977, and details the day's schedule and production requirements.

The nine small behind-the-scenes color photographs are from *Superman II*, showing Superman (Christopher Reeve), Lex Luthor (Gene Hackman), Lois Lane (Margot Kidder), General Zod (Terence Stamp) and others inside the Fortress of Solitude.

The 11 8 x 10 black-and-white photographs are from both the original film and its sequel, and show the actors on set. Some photos show minor creases due to production use and age, but the set remains in very fine condition. Dimensions (call sheet): 36 cm x 22 cm (14" x 8 1/2"); (envelope): 22 cm x 11 cm (8 3/4" x 11 cm); (small photographs): 9 cm x 5 cm (3 1/2" x 5"); (large photographs): 20 cm x 26 cm (8" x 10")

£800-1,000



521. Kryptonite Shard Ω

SUPERMAN (1978)

A kryptonite shard from Richard Donner's superhero film *Superman*. Lex Luthor (Gene Hackman) placed a piece of kryptonite around Superman's (Christopher Reeve) neck in order to render the Man of Steel powerless.

This piece was originally part of the kryptonite necklace utilised by Lex Luthor. It is made of clear resin and shaped like a naturally occurring crystal. The shard is finished with a green tint, giving it the appearance of the alien mineral. The back of the shard shows evidence that it was once part of a larger piece. Overall, this lot is in fine condition.

Dimensions: 5 cm x 4 cm x 2.5 cm (2" x 1 1/2" x 1")

£800-1,200



522. Large Fortress of Solitude Crystal ΩΔ**SUPERMAN (1978)**

A prop crystal from Richard Donner's superhero film *Superman*. Crystals were seen in the Fortress of Solitude when Superman (Christopher Reeve) summoned the consciousness of his father Jor-El (Marlon Brando).

The piece is made of clear resin and shows some wear from production use, but remains in fine overall condition.

Dimensions: 46 cm x 3 cm x 5 cm (18 ¼" x 1" x 2")

£3,000-£5,000

**523. Young Clark Kent's (Jeff East) Wooden Football Ω****SUPERMAN (1978)**

Young Clark Kent's (Jeff East) wooden football from Richard Donner's superhero film *Superman*. Early in the film, a frustrated young Clark Kent kicked a football, which was launched hundreds of feet into the air due to his remarkable strength. To achieve this shot, a wooden football was propelled via an air cannon.

This football is made of solid wood, and both the stitching and a pair of white lines are painted on with broad brushstrokes. The football shows wear to the paint and surface due to production use and age, but remains in fine condition. Dimensions: 29 cm x 16 cm x 16 cm (11 ½" x 6 ¼" x 6 ¼")

£1,500-2,500

**524. General Zod's (Terence Stamp) Beard and Moustache †Δ****SUPERMAN II (1980)**

General Zod's (Terence Stamp) beard and moustache from Richard Lester's superhero sequel *Superman II*. Appliances were used by the make-up department for scenes throughout the film, as General Zod, Ursa (Sarah Douglas) and Non (Jack O'Halloran) threatened Earth after escaping the Phantom Zone. The same appliances were also used during the opening of Richard Donner's *Superman*, as both productions were filmed simultaneously in 1977.

Renowned make-up artist Stuart Freeborn and his team used multiple sets of facial hair appliances, with each piece adhered to the actors' faces using specialist glue. Adhered to pieces of skin-tone mesh, the facial hair pieces consist of a combination of dark brown and grey synthetic hair. The pieces come presented in their original wig box with a label reading "Pinewood Studios, Superman", "Make Up Supervisor Stuart Freeborn" and "4x full beard & moustache set as Terence Stamp".

The facial hair appliances show signs of wear from production use, and several holes are present in the mesh. Dimensions (largest piece): 18 cm x 31 cm x 0.1 cm (7 ¼" x 12 ¼" x ¼"); (wig box): 24.5 cm x 13 cm x 8 cm (9 ¾" x 5 ¼" x 3 ¼")

£400-600



525. Superman (Christopher Reeve) Costume Display 

SUPERMAN (1978) / SUPERMAN II (1980) / SUPERMAN III (1983)

Superman's (Christopher Reeve) costume from Richard Donner's classic superhero film *Superman* and its sequels *Superman II* and *Superman III*, both directed by Richard Lester. A groundbreaking film, the original *Superman* brought a sense of legitimacy to the superhero genre, and earned numerous accolades for its storytelling and visual effects.

The costume was worn in the first two films, which were shot back-to-back, with the cape reused in the third film. The bespoke costume consists of a tunic, a cape, a pair of trunks, a belt, a pair of leggings and a pair of boots.

Superman's instantly recognisable long-sleeve tunic is made of a custom-woven, stretchy blue nylon material manufactured during the production, and displays Superman's classic "S" logo in red and gold on the chest. The tunic has a hidden zipper at the back, and features a Bermans & Nathans wardrobe label stitched near the neck that reads "CHRISTOPHER REEVE 12312 MUSCLES SUPERMAN", as it was designed to be worn with a muscle suit. The leggings are made of the same material, and include a wardrobe label that reads "CHRISTOPHER REEVE WATER SUPERMAN" as it was designed to be worn during shots in a water tank. The tunic and the leggings both include holes at the waist, which allowed the actor to be wired for flying scenes.

The red trunks feature an elastic waistband with a label that reads "CHRISTOPHER REEVE 12312 SUPERMAN NEW", and include a yellow-painted leather belt that fastens at the back with hook-and-bar closures. The knee-length cape is made of red wool, and attaches to the tunic via snap-buttons on the shoulders. The back of the cape features a yellow stitched "S" logo with black threading. Two labels are stitched inside, one reading "REMADE OCT/82 WALK HB 4 NEW CAPE", and the other reading "CHRISTOPHER REEVE WALKING CAPE 14-9-79". This indicates that the cape was made for the original film, and then remade for the third. Superman's knee-high boots are made of red leather, and display "FLYING ONLY" handwritten inside each boot using black ink. The boots close at the back with a zipper hidden behind a leather flap.

The classic costume is mounted on a bespoke mannequin with a painted lifecast of Christopher Reeve screwed in place. The statue is mounted to a metal base in the shape of Superman's emblem, with a rod entering the left boot through the zipper, which is stitched shut. The complete costume shows minor wear due to production use and age, with one missing cape shoulder button and a few stray threads on the cape, along with a few moth holes. The costume remains in otherwise very fine condition. Dimensions (on display): 91.5 cm x 51 cm x 198 cm (36" x 20" x 78")

£60,000-80,000



526. Superman's (Christopher Reeve) Green Crystal Ω

SUPERMAN II (1980)

Superman's (Christopher Reeve) green crystal from Richard Lester's superhero sequel *Superman II*. After Superman created the Fortress of Solitude in the first film using the Crystal of Knowledge, the crystal made a second appearance in the sequel when it restored Superman's powers by exhausting the last of Jor-El's (Marlon Brando) energy.

This piece is made of clear resin and is tinted green. The crystal has five faces, making it fit with the Kryptonian aesthetic of the Fortress of Solitude. The lot shows some signs of wear, including slight scratching to the surface, and is in fine overall condition. Dimensions: 20 cm x 2.5 cm x 1.5 cm (8" x 1" x ½")

£5,000-7,000



527. Production-Used Script †Δ

SUPERMAN II (1980)

A production-used script from Richard Lester's superhero sequel *Superman II*. Written by David and Leslie Newman, this second draft is dated 20th July 1979 and was issued to construction manager Terry Apsey.

The script is bound in a blue card cover with script clips, and consists of 140 A4 pages printed on white paper. The script displays wear from production use, including minor marks on the card cover, marks due to corrosion on the metal clips and folds in some of the pages.

Dimensions: 30 cm x 21 cm x 2 cm (12" x 8 ¼" x ¾")

£300-500



528. Daily Planet "Superman Extinguishes Flames" Newspaper M

SUPERMAN III (1983)

A Daily Planet "Superman Extinguishes Flames" newspaper from Richard Lester's superhero sequel *Superman III*. The production-made newspaper refers to the moment 'evil' Superman (Christopher Reeve) blew out the Olympic flame, but the sequence was ultimately not used in the final cut of the film.

Consisting of the front and back cover, the piece is printed on newspaper stock with the Daily Planet logo at the top. A black-and-white image of Superman standing proudly features on the front, with various articles surrounding the photo and multiple advertisements adorning the back cover. The newspaper displays minor discoloration, a fold line due to storage, and two small tears on the top edge. Dimensions: 57.5 cm x 42.5 cm (22 ¾" x 16 ¾")

£500-700

529. Gil Kane Hand-Drawn Cover Artwork Ω

SUPERMAN / ACTION COMICS #551 (1984)

Hand-drawn cover artwork by Gil Kane featuring Superman, from *Action Comics* #551. In this issue, the Man of Steel raced against time to save two children in peril.

This original pencilled-and-inked cover artwork is drawn on Bristol board by Gil Kane. The centrepiece of the cover shows Superman straining to pull back a clock hand. Around the clock are five additional drawings of Superman performing heroic deeds.

Pasted onto the artwork is the DC logo, issue block, title art, barcode block and taglines, which read: "THINK YOU'VE HAD A TOUGH DAY", "LOOK WHAT SUPERMAN'S BEEN THROUGH!" and "AND THE DAY ISN'T EVEN OVER YET". On the back of the sheet is a DC Comics stamp and a handwritten date: "7/13/83". Included with the lot is a reference copy of *Action Comics* #551, the comic book in which this art was originally published. Some white-out correction fluid is present, but the artwork remains in very fine condition. Dimensions: 28 cm x 42.5 cm (11" x 16 ¾")

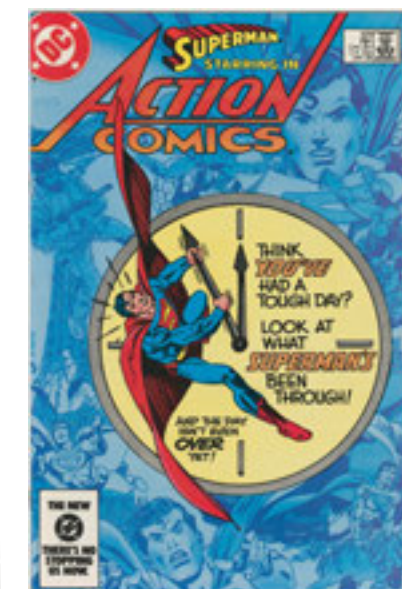

Please note this lot is sold without copyright, reproduction rights, licensing agreements or any other type of legal release.

£3,500-4,500





530. Bernie Wrightson Hand-Drawn Page Six Artwork Ω

SWAMP THING / THE HOUSE OF SECRETS #92 (1971)

Hand-drawn page six artwork by Bernie Wrightson featuring Swamp Thing in his introductory story "Swamp Thing", from *The House of Secrets #92*. The page features five panels with Swamp Thing observing his former friend, Damian Ridge, preparing to murder the love of his life, Linda.

In drawing this story, Wrightson used his friends Mike Kaluta, Louise Jones, Alan Weiss and himself as models. This page features Jones as Linda and Kaluta as Damian. This is one of only five pages in the first Swamp Thing story that features Swamp Thing himself on the page.

This original pencilled-and-inked artwork is drawn on Bristol board by Bernie Wrightson. Included with this lot is a reference copy of Silver Age Classics House of Secrets #92 (1992). This comic book reprinted the story from *The House of Secrets #92*, in which this art was originally published. Some white-out correction fluid is present, and the board has tack holes at the top and bottom. However, the artwork is in very good condition. Dimensions: 40 cm x 27 cm (15 3/4" x 10 1/2")

Please note this lot is sold without copyright, reproduction rights, licencing agreements or any other type of legal release.

£9,000-12,000

531. Team America Hummer H2 Model Miniature US

TEAM AMERICA: WORLD POLICE (2004)

A Team America Hummer H2 model miniature from Trey Parker's action comedy *Team America: World Police*. Performed by marionette puppets, the film followed Broadway actor Gary Johnston (Trey Parker) who was recruited by the elite counter-terrorism organisation Team America. The group deployed a Hummer while they chased enemy operatives through the streets of Egypt.

This Hummer model is based on the H2 model. It is constructed from a fibreglass shell placed over a steel frame. The outside of the piece is painted with a patriotic red, white and blue theme, and the team's crest is boldly displayed on the bonnet. The Hummer rests on four Kenda Turf Rider lawnmower tires.

Numerous modifications are present on the outside of the vehicle, including resin rockets, resin thrusters and a functioning set of emergency lights, which are powered via a 9-volt battery. The bonnet opens to reveal a ramp that was deployed when the team needed to send an enemy car over the Hummer. This ramp is made of resin. Additionally, the vehicle's grille houses two hidden machine guns. These were originally deployed via mechanisms that have been removed. As a result, the guns must now be revealed manually. The piece shows some wear to the outside, including scratches throughout and missing rockets, but remains in fine overall condition. Dimensions: 178 cm x 85.5 cm x 79 cm (70" x 34" x 31")

This item contains electronic components. While every effort is made to describe them accurately, no guarantee or warranty is made as to the functionality, lifespan or safety of those components. It is entirely incumbent on the new owner to satisfy themselves as to their safe use and maintenance.

£4,000-6,000

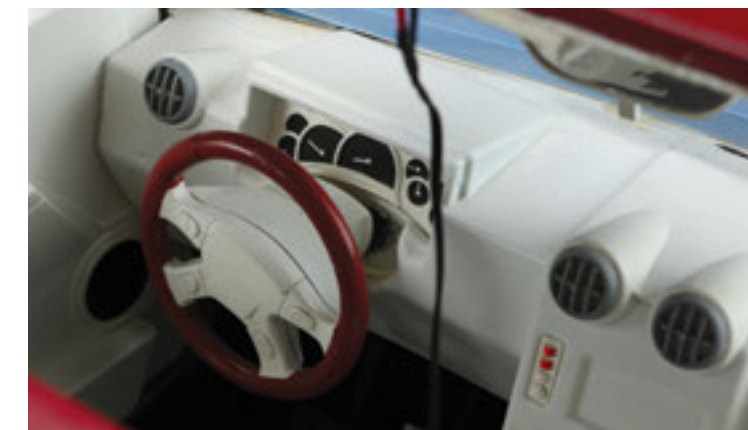

532. Team America's Attack Helicopter Ω

TEAM AMERICA: WORLD POLICE (2004)

Team America's attack helicopter from Trey Parker's action comedy *Team America: World Police*. Performed by marionette puppets, the film followed Broadway actor Gary Johnston (Trey Parker) who was recruited by the elite counter-terrorism organisation Team America. The group used a helicopter in numerous missions, and when they travelled to Egypt.

The piece features a set of wires emerging from the tail. These wires, hidden by keeping the tail off-screen, powered a small motor inside the helicopter that rotated its blades. These components have not been tested for functionality. The helicopter shows wear from storage, such as blades that are reattached with glue and a missing rear landing wheel. However, the piece remains in fine overall condition. Dimensions: 48 cm x 13 cm x 13 cm (19" x 19" x 5")

This model helicopter consists of a fibreglass shell with resin components. The front of the helicopter contains faux tinted windows and the piece is painted to have a patriotic theme. Portions of the model have been covered with coloured tape by the production. This helicopter screen-matches to the scene in which the Team America aircraft are seen flying in formation.

This item contains electronic components. While every effort is made to describe them accurately, no guarantee or warranty is made as to the functionality, lifespan or safety of those components. It is entirely incumbent on the new owner to satisfy themselves as to their safe use and maintenance.

£2,000-3,000



533. Spottswode's Lamborghini Diablo Limousine Model Miniature US

TEAM AMERICA: WORLD POLICE (2004)

Spottswode's Lamborghini Diablo limousine model miniature from Trey Parker's action comedy *Team America: World Police*. Performed by marionette puppets, the film followed Broadway actor Gary Johnston, who was recruited by the elite counter-terrorism organisation Team America. Gary accepted a ride from Spottswode early in the film, who drove the limousine, which doubled as a jet, to the Team America headquarters.

The bespoke limousine consists of a fibreglass shell with resin, plastic, wood and metal components. The vehicle features numerous dark-tinted faux windows, with three on the left, two each on the right, front and back, and two sunroofs.

On the left side of the limousine is a functioning door, which opens to reveal luxurious seating within. The miniature shows wear due to production use, with one of the side mirrors missing, along with the front left headlight. The lot remains in good overall condition.

Dimensions: 312 cm x 84 cm x 48 cm (112" x 33" x 19")

£2,000-3,000



534. Lilia's (Debra Paget) Slave Costume Ω

THE TEN COMMANDMENTS (1956)

Lilia's (Debra Paget) slave costume from Cecil B. DeMille's Biblical epic *The Ten Commandments*. Lilia, a Hebrew slave who married Joshua (John Derek), wore her slave outfit in numerous scenes.

The costume consists of a burgundy-coloured woven tunic with a striped sash, and a red headscarf. The sleeveless tunic ties at one shoulder and has a Paramount wardrobe label hand-stitched inside that has "Lilia #1" written on it in black ink. The costume shows wear due to age and intentional production distressing, with frayed edges and dirt applied throughout.

£4,000-6,000

535. The Terminator's Blown-Up Endoskeleton Skull Fragment Ω

THE TERMINATOR (1984)

The Terminator's blown-up endoskeleton skull fragment from James Cameron's sci-fi action film *The Terminator*. Kyle Reese (Michael Biehn) used a pipe bomb to blow up the Terminator (Arnold Schwarzenegger) in an industrial warehouse.

Created by Stan Winston Studio, this skull was part of a full-size ceramic endoskeleton that was rigged with charges and blown up by the Second Unit. The skull is painted to resemble metal and is cast over a metal support rod. Numerous wires are still embedded in the head, which were previously rigged

for the explosives used to detonate the prop. Accompanying this item is a letter of authenticity from set dresser Gregory R. Wolf. The item exhibits wear due to production use and age, with breaks in the plaster due to the nature of the scene. The piece remains in fair condition.

Dimensions: 15 cm x 20 cm x 15.5 cm (6" x 8" x 6 1/2")

£2,000-3,000



536. The Terminator's (Arnold Schwarzenegger) Jacket Ω

THE TERMINATOR (1984)

The Terminator's (Arnold Schwarzenegger) jacket from James Cameron's sci-fi action film *The Terminator*. Sent by Skynet from the year 2029, the Terminator was an advanced cyborg killing machine whose sole mission was to kill Sarah Connor (Linda Hamilton), a woman whose unborn son was the key to humanity's salvation. The Terminator acquired a punk jacket and outfit when he first time-travelled to 1984 Los Angeles, and wore the ensemble in numerous scenes.

The commercially produced jacket is made of grey cotton and is modified to appear more punk, with metal-studded faux-leather components stitched to portions of the jacket, along with decorative chains attached to the left shoulder. Faux leather is also stitched to the interior of the collar. The jacket shows production distressing, with stage blood applied around the numerous bullet-holes created by Kyle Reese's (Michael Biehn) shotgun blasts.

The costume is outfitted with padding at the shoulders, and has additional heavy nylon material inside the right sleeve that is believed to be fire retardant material for a stunt in which the Terminator runs through fire while pursuing Kyle and Sarah Connor.

Accompanying this lot are 30 vintage lobby cards and photographs showing Arnold Schwarzenegger in costume as the Terminator. Accompanying the jacket is a letter of authenticity attributing its original purchase from the Retake Room in Los Angeles, a company that sold movie wardrobe items during the 1980s and 1990s. The item exhibits intentional wear due to production use and age, with some fabric hardening where the stage blood has dried. The jacket remains in otherwise good condition.

Dimensions (photographs): 20 cm x 25.5 cm (8" x 10")

£20,000-30,000



537. Revised Production Script and Eight Production Binders Ω

TERMINATOR 2: JUDGMENT DAY (1991)

A revised production script and eight production binders from James Cameron's sci-fi action sequel *Terminator 2: Judgment Day*. Bound with three brads, the revised draft script is dated "July 18, 1990", with each page featuring production-tracking stamps that read "T20099" and "Property of Lightstorm Entertainment, Inc. Not for Duplication". The script comprises 124 US letter pages and includes handwritten annotations on the first six pages.

Additionally, this lot includes eight production binders, which contain printed concept artwork, printed storyboards, rough hand-drawn sketches, calendars, scene breakdowns, shooting schedules, production slides, memos, invoices, faxes and other production documentation. The binders and their contents remain in good condition.

Dimensions (combined): 35.5 cm x 51 cm x 30.5 cm (14" x 20" x 12")

£2,000-3,000



538. Sarah Connor's (Linda Hamilton) Jacket Ω

TERMINATOR 2: JUDGEMENT DAY (1991)

Sarah Connor's (Linda Hamilton) jacket from James Cameron's sci-fi action sequel *Terminator 2: Judgment Day*. Sarah took this jacket from Chet's Auto Shop, a temporary hideout, after being rescued from Pescadero State Hospital. She also wore it later when she brought her son John (Edward Furlong) and the Terminator (Arnold Schwarzenegger) to retrieve her weapons stash from Enrique (Castulo Guerra). This jacket screen-matches to numerous scenes, including the one in which Sarah leaves Chet's Auto Shop.

The jacket is made of faded blue denim, with tan corduroy collar and cuffs. The interior of the jacket shows stage blood from Sarah's injury, inflicted by the T-1000 (Robert Patrick) in an elevator. The jacket was modified for the production, with the most of the buttons removed, and heavy beads stitched inside the bottom-right front hem to weigh it down. The item shows intentional distressing, but remains in very fine condition.

£3,000-5,000



539. T-1000 (Robert Patrick) Bullet-Hit Appliances Ω

TERMINATOR 2: JUDGEMENT DAY (1991)

T-1000 (Robert Patrick) bullet-hit appliances from James Cameron's sci-fi action sequel *Terminator 2: Judgment Day*. Made of liquid metal, the T-1000 was an advanced Terminator that could shapeshift into any solid form it touched. As it was made of a mimetic polyalloy, the T-1000 would display rippled impact hits whenever it was shot.

The lot consists of seven appliances. The bullet-hits are made of foam latex, with most shaped in circular layers with a ripple effect. The foam is painted in a metallic silver colour, and three of the bullet-hits are glued to Spandex material. The largest appliance consists of two overlapping bullet-hits that are melded together. The foam has become brittle on one of the bullets, and most show flaking to the paint; however, the set remains in good overall condition.

Dimensions (largest): 20 cm x 13 cm x 5 cm (8" x 5" x 2"); (smallest): 6 cm x 6 cm x 2.5 cm (2 1/2" x 2 1/4" x 1")

£1,500-2,000

540. The Terminator's (Arnold Schwarzenegger) Hero Rose Box Ω

TERMINATOR 2: JUDGEMENT DAY (1991)

The Terminator's (Arnold Schwarzenegger) hero rose box from James Cameron's sci-fi action sequel *Terminator 2: Judgment Day*. The Terminator hid his shotgun inside a box of roses when he tracked John Connor (Edward Furlong) to a local mall.

The piece consists of a modified gold-coloured present box with a sheet of clear plastic glued over a wavy viewing hole, cut out to display the roses inside. The lid shows numerous wrinkles from being handled, which screen-matches the box to the scenes in which the Terminator carries it through the crowded mall. The roses feature felt flower petals with plastic stems and leaves. The lot shows minor wear, but remains in very fine condition.

Dimensions: 76 cm x 13 cm x 9 cm (30" x 5" x 3 1/2")

£4,000-6,000



Moviestore Collection/REX/Shutterstock

541. T-1000 Bullet-Hit Shirt M**TERMINATOR 2: JUDGMENT DAY (1991)**

The T-1000's (Robert Patrick) bullet-hit shirt from James Cameron's sci-fi action sequel *Terminator 2: Judgment Day*. The T-1000 wore its police shirt during the asylum sequence as it chased The Terminator (Arnold Schwarzenegger), Sarah Connor (Linda Hamilton) and her son John (Edward Furlong), before transforming its arms into claws to hook onto their car. Throughout the sequence, The Terminator and Sarah shot him with their shotgun and pistol respectively, opening up holes in the T-1000's liquid metal body. The film won numerous awards including Academy Awards® for Best Visual Effects and Best Make-Up.

Made from a polyester blend, the shirt is based on a navy blue police uniform, with an official label stitched to the bottom. Each sleeve tapers into a fibreglass bar, ending in a claw. The costume would have been used when steel or rubber stunt versions weren't required, and was for transitional sequences which occurred between those in which the T-1000 exited the hospital garage, was dragged by the car and shot by The Terminator over his shoulder.

The shirt fastens with six large, blue plastic buttons and features two pockets and epaulettes. Twelve foam-latex 'bullet holes' cover its front, with two large holes on the back. These are finished in faux-silver paint, designed to replicate bullet hits on the T-1000's liquid metal body. Age and production use are evident, including paint chips, minor stains and some deterioration of the foam latex. The right sleeve is partly torn at the elbow.

Dimensions (on stand): 35 cm x 60 cm x 162 cm (13 ¾" x 23 ¾" x 63 ¾")

£10,000-15,000

**542. The Terminator's (Arnold Schwarzenegger) Battle-Damaged Leather Gloves with Endoskeleton Fingers Ω****TERMINATOR 2: JUDGMENT DAY (1991)**

The Terminator's (Arnold Schwarzenegger) battle-damaged leather gloves with endoskeleton fingers from James Cameron's sci-fi action sequel *Terminator 2: Judgment Day*. The Terminator damaged his hands after he crashed into a steel mill at the climax of the film.

The gloves are made of black leather and feature urethane appliances stitched inside. Parts of the glove are distressed and torn by the production, to expose the appliances underneath, which resemble the Terminator's bloody hands with robotic fingers. The gloves include foam hands to help them keep their shape. They show intentional wear, but remain in very fine condition.

Dimensions (each): 18 cm x 25 cm x 8 cm (7" x 9 ¾" x 3")

£4,000-6,000

**543. The Terminator's (Arnold Schwarzenegger) Battle-Damaged Chest Appliance Ω****TERMINATOR 2: JUDGMENT DAY (1991)**

The Terminator's (Arnold Schwarzenegger) battle-damaged chest appliance from James Cameron's sci-fi action sequel *Terminator 2: Judgment Day*. The Terminator sustained significant damage to his body after the attack on Cyberdyne, and later when he confronted the T-1000 (Robert Patrick) at the steel mill.

Worn under the Terminator's torn shirt, the appliance simulated damaged, bloody skin, with the T-800's metal endoskeleton appearing beneath. The skin is made of foam latex and is distressed to appear charred, torn and bloody. Beneath the skin is a dense urethane endoskeleton, which is painted metallic silver and grey. The appliance is backed with black material that is attached to elastic bands for fastening to the actor. The foam-latex skin has become brittle around the edges of the appliance, but the piece remains in otherwise good condition.

Dimensions: 37 cm x 30 cm x 8 cm (14 ½" x 11 ¾" x 3")

£4,000-6,000

544. The Terminator's (Arnold Schwarzenegger) Costume Ω

TERMINATOR 2: JUDGEMENT DAY (1991)

The Terminator's (Arnold Schwarzenegger) costume from James Cameron's sci-fi action sequel *Terminator 2: Judgment Day*. The Terminator wore his signature costume throughout the film after he stole it from a biker at a bar. This costume is distressed from the Terminator's encounter with S.W.A.T. at Cyberdyne Systems near the end of the film.

The costume is comprised of a custom-made black leather jacket, a matching pair of black artificial leather trousers with a leather belt, grey Hanes Beefy-T T-shirt, marked size extra-large, a bandolier and a pair of motorcycle boots, marked size 12. The leather zip-up jacket is distressed to look hard-worn, riddled with bullet holes sustained from the attack on Cyberdyne, and scratches to the leather. The interior lining shows production incisions to insert squibs for FX shots. Worn under the jacket is a grey T-shirt which shows a large hole at the chest where an endoskeleton appliance would have been visible. The trousers close in front with a zipper and snap button, and display a hole at the rear that is covered in black tape. The Harley-Davidson boots appear to be a mismatched pair, are made of leather with varying style of rubber soles, and shows 'A' written inside one boot with silver marker. The bandolier is made of nylon with steel buckles, and includes 11 elastic slots for ammunition. The belt features five resin grenade rounds, which are painted bronze and silver, giving them the impression of being made of metal. Although faded on most, each grenade shows 'PROJ M381' printed on the central silver casing.

Accompanying the jacket is a pair of photographs and a signed letter of authenticity from Guns n' Roses keyboardist, Dizzy Reed, who was gifted the jacket from Schwarzenegger after wrapping the shoot for the music video You Could Be Mine. The costume displays natural wear from use, with some additional corrosion to the buttons, buckles and zippers across the jacket. The trousers show minimal signs of wear, with minor delamination to the faux leather. The bandolier is distressed by the production with tears to the nylon and light paint to appear battle damaged. The lot shows intentional distressing but remains in very fine condition.

£18,000-22,000



545. Light-Up T-800 Terminator Endoskeleton Ω

TERMINATOR 2: JUDGEMENT DAY (1991)

A light-up T-800 Terminator endoskeleton from James Cameron's sci-fi action sequel *Terminator 2: Judgment Day*. Renowned for its groundbreaking visual effects, *Terminator 2* combined both practical and newly pioneered digital effects to set the new standard for action blockbusters, garnering numerous Academy Awards® for its technical achievements. The endoskeleton was created by Cameron's long-time collaborator, Stan Winston Studio. The *Terminator 2* Endoskeletons were actively rebuilt during production and after production of the film; some pieces were harvested for use in the theme park attraction T2:3D and for other related needs. For this reason, few if any of the original Endoskeletons built for the film are in their exact original condition today. The Endoskeleton offered here incorporates components potentially made by Winston after *Terminator 2* production; the head of the piece exhibits a notably different plating finish to the body and may be from T2:3D. Building from the original film's *Terminator* design, the studio was tasked with creating numerous endoskeletons for the sequel's future-war opening sequence, including both cable-controlled puppets and static Endoskeletons.

This Endoskeleton is largely made of chrome-plated two-part resin, with an internal support armature which is found in the torso and engineered into some of the limbs, such as the lower legs. Most of the joints on the piece are practical, including the shoulders, elbows and knees. These pivot points and their accompanying functional compression rods and dummy pistons allow the figure to be poseable, to a degree. One of the fingers on the piece is soft urethane; all other components are rigid resin. The piece is finished with additional dressing, such as real-world pressure hoses and hose fittings that contribute to its realistic appearance.

The T-800 Terminator Endoskeleton is the signature piece for one of the most beloved science-fiction franchises in cinema. The Endoskeleton has undergone minor cosmetic restoration and has been securely mounted to a base for display purposes. Due to the intricate nature of the piece, it remains delicate. The eyes have been restored to function with LED lights, as the original bulbs have since been removed, and are wired to turn on via a hidden switch. Showing some wear due to use and age, with mended breaks to the resin, the *Terminator* Endoskeleton remains in fine condition. This Endoskeleton is showcased in the book *Terminator Vault* by Ian Nathan. Dimensions: 63.5 cm x 28 cm x 190.5 cm (25" x 11" x 75")

Dimensions: 63.5 cm x 28 cm x 190.5 cm (25" x 11" x 75")

This item contains electronic components. While every effort has been made to describe them accurately, no guarantee or warranty is made as to the functionality, lifespan or safety of those components. It is entirely incumbent on the new owner to satisfy themselves as to their safe use and

£200,000-300,000

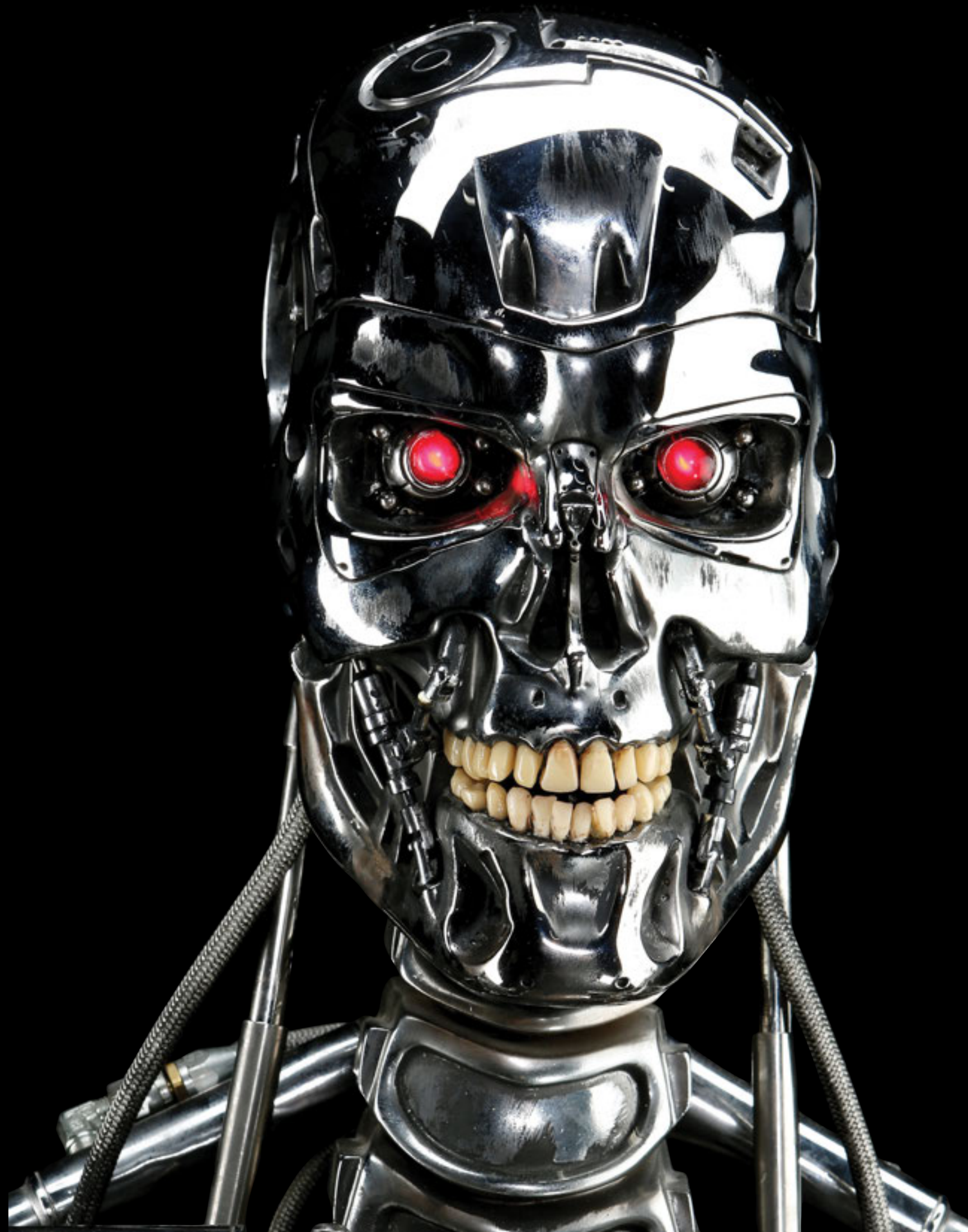

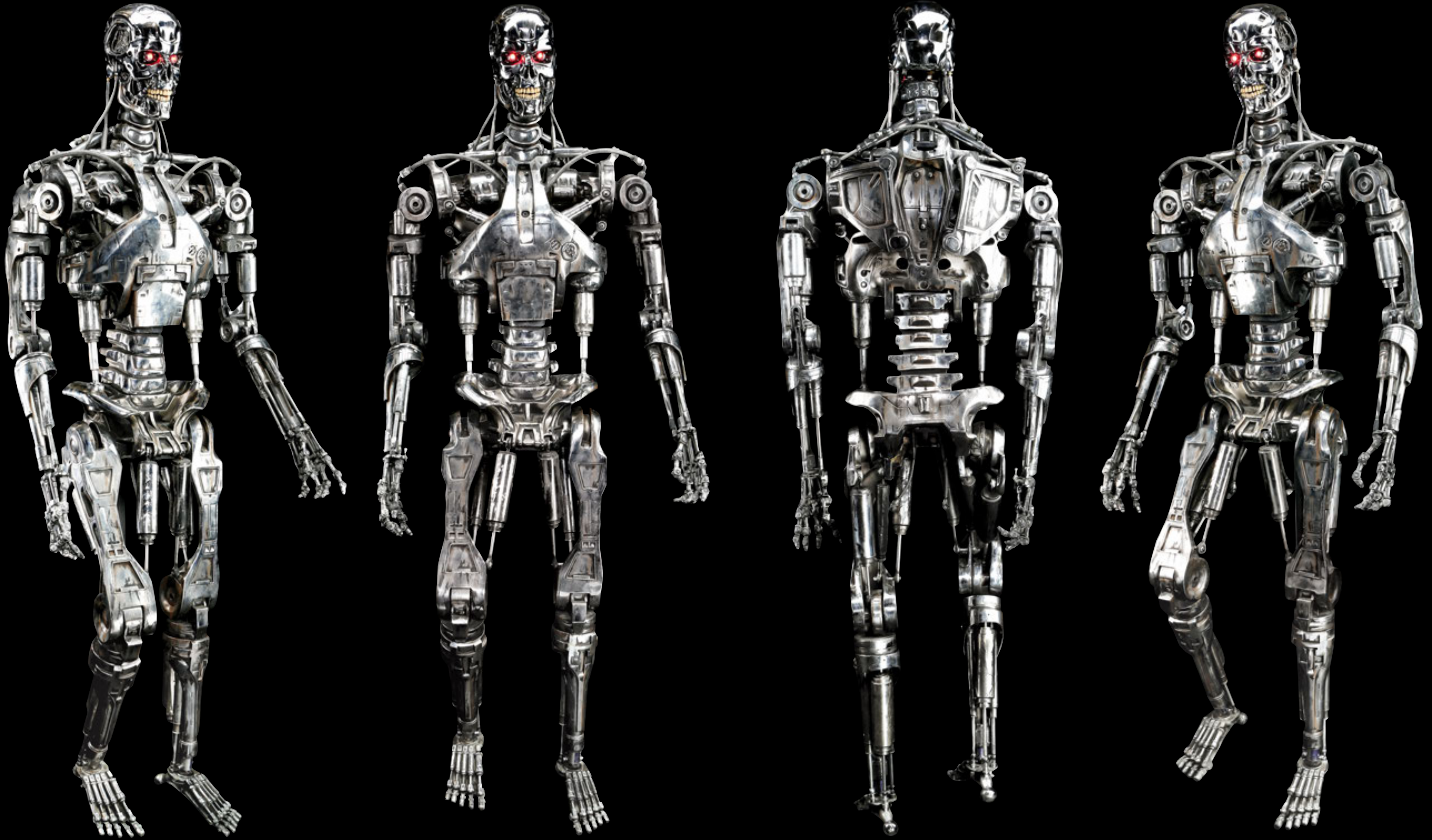

546. Bone Kitchen Knife M**THE TEXAS CHAIN SAW MASSACRE (1974)**

A bone kitchen knife from Tobe Hooper's horror film *The Texas Chain Saw Massacre* (1974). Many household objects found in Leatherface's (Gunnar Hansen) home were made from bones and body parts, including knives found on the wall of the kitchen where he savagely murdered Kirk (William Vail), Pam (Teri McMinn) and Jerry (Allen Danziger).

The handle of the knife is made of animal bone, with a rusty serrated metal blade. The blade has been crudely attached to the inside of the bone handle using a large metal screw and washer. A short length of leather thong, which would have been used to secure it to the set wall, has fallen away from the knife due to age. The knife is accompanied by an autographed photograph of Gunnar Hansen as Leatherface. Created by the production to appear worn and well-used, the knife remains in very good condition. Dimensions (knife): 41.5 cm x 20.5 cm x 8.5 cm (16 1/4" x 8 1/4" x 3 3/4"); (photograph): 50 cm x 40 cm (19 3/4" x 15 3/4")

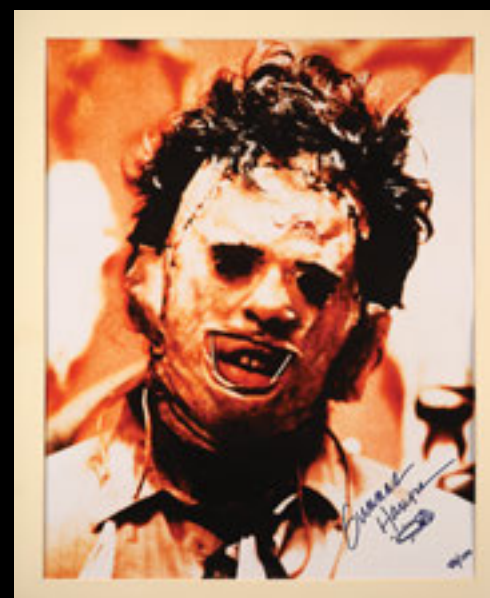
£2,000-3,000**547. Daniel Plainview's (Daniel Day-Lewis) Riding Costume Ω****THERE WILL BE BLOOD (2007)**

Daniel Plainview's (Daniel Day-Lewis) riding costume from Paul Thomas Anderson's Academy Award®-winning period drama *There Will Be Blood*. Nominated for Best Picture, and garnering a Best Actor win for Day-Lewis, the film followed Daniel Plainview in his pursuit of wealth during the oil boom at the end of the 19th century. Plainview wore his riding costume when he rode his horse to see William Bandy (Colton Woodward) in order to purchase his land.

Plainview's costume consists of a reversible coat, a long-sleeve button-up shirt and a pair of riding trousers. The reversible coat was worn with its leather side as the exterior, while the collar and interior are made of brown corduroy. The jodhpur-style riding trousers are made of wool with leather patches stitched between the thighs. The trousers feature a button fly and button-up ankles. All three components feature stitched wardrobe labels that read "Costume design by Mark Bridges". The costume exhibits minor wear due to production use, but remains in very fine condition.

£1,500-2,500

548. Jack Kirby and Dick Ayers Hand-Drawn Page 10 Artwork Ω

THOR / JOURNEY INTO MYSTERY #84 (1962)

Hand-drawn page 10 artwork by Jack Kirby and Dick Ayers featuring Thor facing off against communists for *Journey Into Mystery #84*. Marking only the second appearance of Thor, this issue found the God of Thunder battling the Executioner and the spread of communism. This issue also introduced Thor's love interest, Jane Foster, who appears on this page in the bottom right panel.

Handwritten at the top of the sheet is "Journey Into Mystery 84" and "P. 12". Included with the lot is a reference copy of *Marvel Tales #3* (1966), the first comic book to reprint the Thor story from *Journey into Mystery #84*. The artwork shows minor staining to the front and back, but remains in very good condition.

Dimensions: 56 cm x 34 cm (22" x 13 1/2")

Please note this lot is sold without copyright, reproduction rights, licencing agreements or any other type of legal release.

£15,000-20,000

This original pencilled-and-inked artwork is drawn on Bristol board by penciller Jack Kirby and inker Dick Ayers. The panels show Thor destroying a tank battalion with his hammer, Mjolnir. Most panels contain original handwritten dialogue in pencil that has only been partially erased, allowing insights into the creative process.

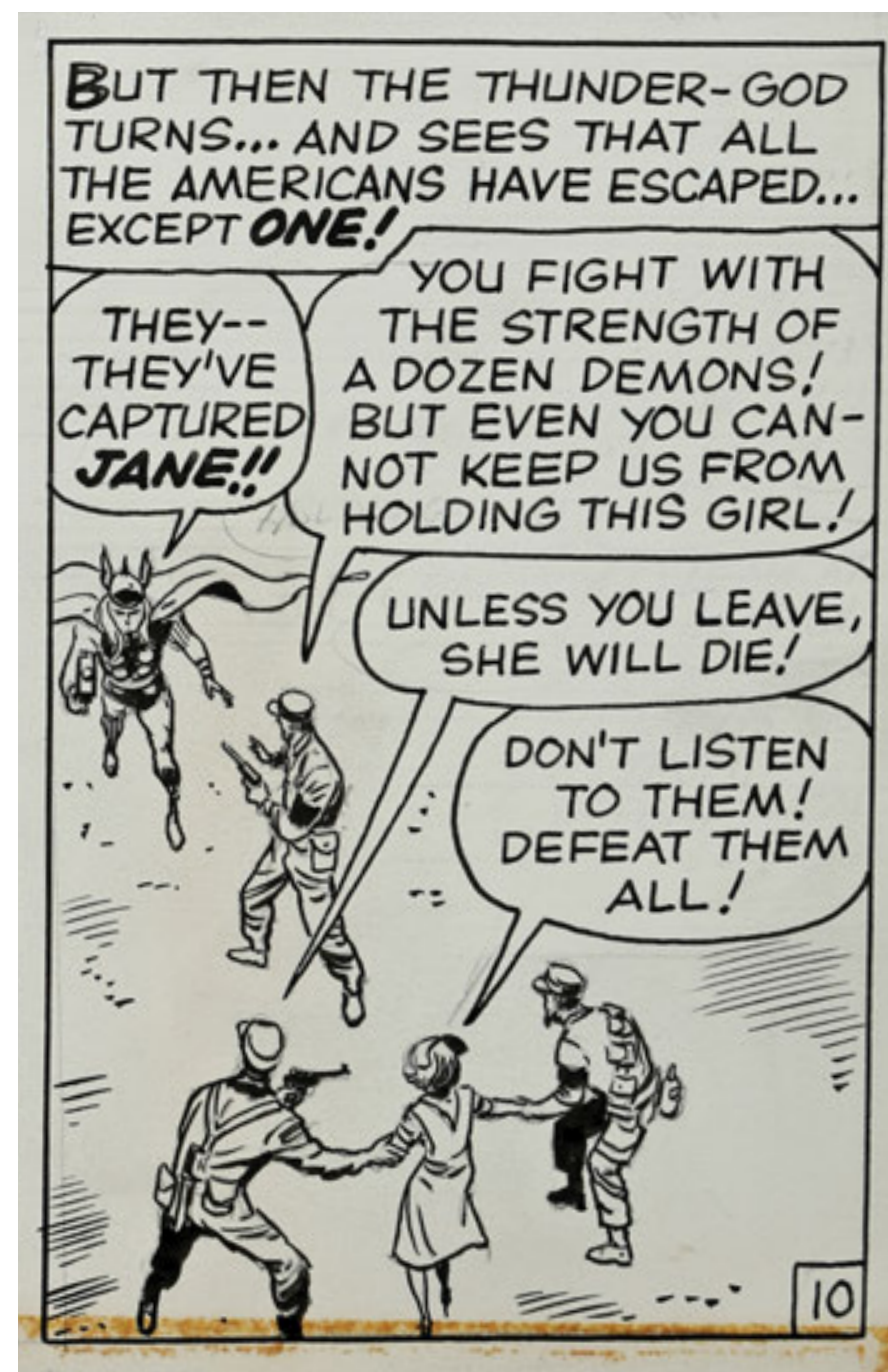

12.

549. Large Scale Model Miniature Titanic Funnel ΔUS

TITANIC (1997)

A large scale model miniature funnel from James Cameron's Academy Award®-winning historical romance *Titanic*. Multiple model miniatures were produced for the disaster film's epic visuals. This particular funnel comes from a large scale 1/8 sized model of the Titanic.

Built by Donald Pennington, this large smokestack is made of metal with a wooden substructure inside for support. The exterior is detailed with cables, a ladder, and faux rivets for added realism. The side of the piece is signed by Pennington in marker and reads '1/8th Scale Funnel Titanic '97 Film Built by Donald Pennington.'

The funnel shows wear from age and use, including marks to the paint and portions of the ladder which are disconnected from the main body, but the lot remains in good condition.

Dimensions: 101.5 cm x 73.5 cm x 244 cm (40" x 29" x 96")

£3,000-10,000

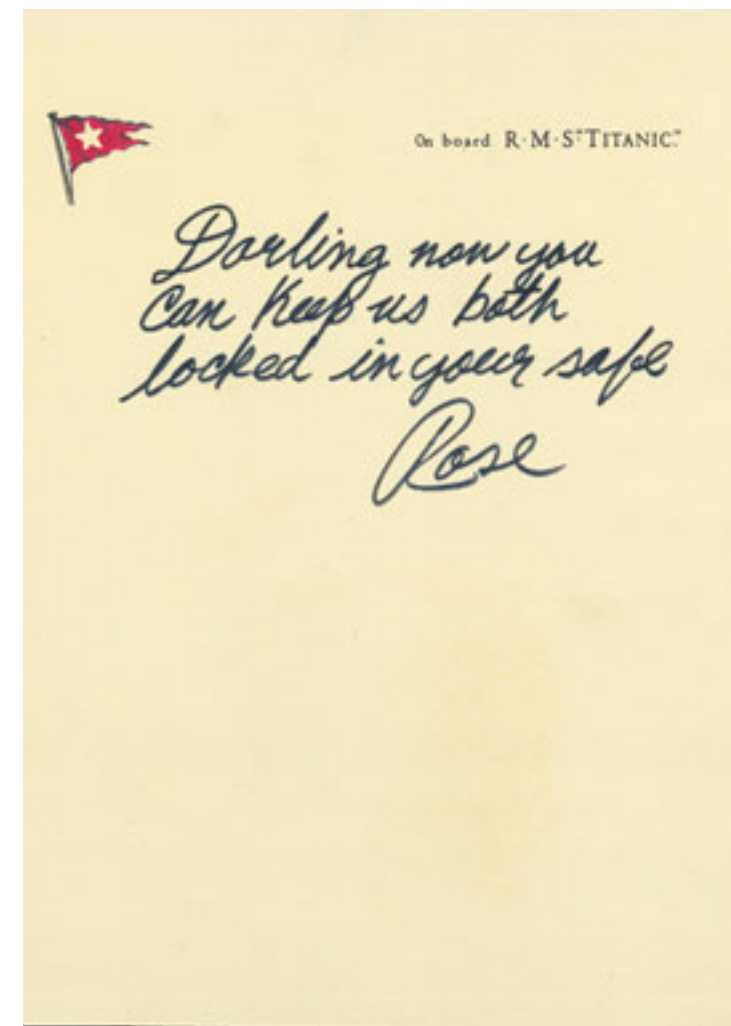
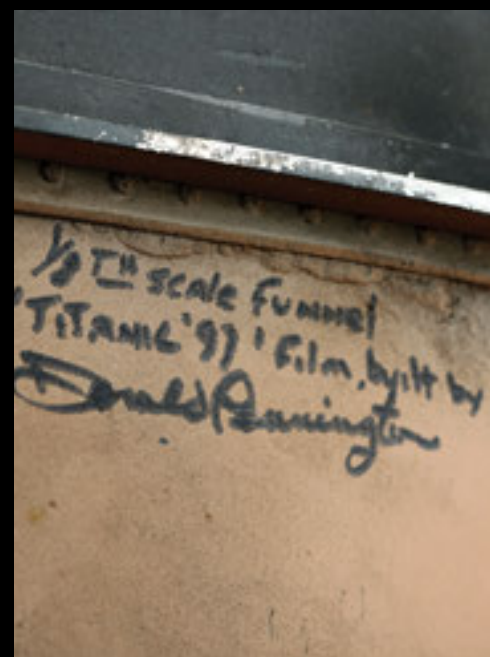

550. Rose's (Kate Winslet) Farewell Note Ω

TITANIC (1997)

Rose's (Kate Winslet) farewell note from James Cameron's Academy Award®-winning historical romance *Titanic*. Rose left a brief letter to her fiancé Cal (Billy Zane), shortly after Jack (Leonardo DiCaprio) drew her portrait. Cal later discovered the note, along with Rose's nude portrait.

The note is written on Titanic stationery, with a red White Star Line flag printed on the left, and "On board R.M.S. "TITANIC"" at the right. Below the letterhead is Rose's note, which reads: "Darling now you can keep us both locked in your safe — Rose" printed in black ink.

Accompanying this lot is a certificate of authenticity from 20th Century Fox. Rose's note shows minor wear due to production use, but remains in very fine condition.

Dimensions: 23.5 cm x 17 cm (9 1/4" x 6 3/4")

£4,000-6,000

551. Doug Quaid's (Arnold Schwarzenegger) Jacket M

TOTAL RECALL (1990)

Doug Quaid's (Arnold Schwarzenegger) jacket from Paul Verhoeven's sci-fi action thriller *Total Recall*. Quaid wore his jacket in numerous scenes throughout the film as he discovered he had his memory wiped, forcing him to forget he was in fact Mars Intelligence agent Carl Hauser.

The jacket is made from green cotton with a light brown lining and decorative tan leather collar. Multiple pockets adorn the garment, along with an elasticated waistband and seam detailing on the back. Metal poppers have been adhered to the cuffs and a gold-coloured zip runs down the front. Loose threads and plucks are present on the pockets, along with minor discolouration and a mark on the waistband from use on production. The jacket is accompanied by a letter of authenticity from the Key Grip on the production, W.C. 'Chunky' Huse.

£1,500-3,000





552. Herb Trimpe Hand-Drawn Cover Artwork Ω

THE TRANSFORMERS #26 (1987)

Hand-drawn cover artwork by Herb Trimpe featuring the introduction of the Mechanic for issue #26 of *The Transformers*. The cover shows the Mechanic brandishing dual rifles with a pile of fallen Autobots behind him.

This original pencilled-and-inked cover artwork is drawn on Bristol board by Herb Trimpe. The title art is not present, with the top of the cover left intentionally blank.

Included with the lot is a reference copy of *Transformers #26*, the comic book in which this art was originally published. Some white-out correction fluid is present

and the board has a staple near the top left corner. The artwork is in very good condition. Dimensions: 43 cm x 28 cm (17" x 11")

Please note this lot is sold without copyright, reproduction rights, licencing agreements or any other type of legal release.

£2,000-2,500

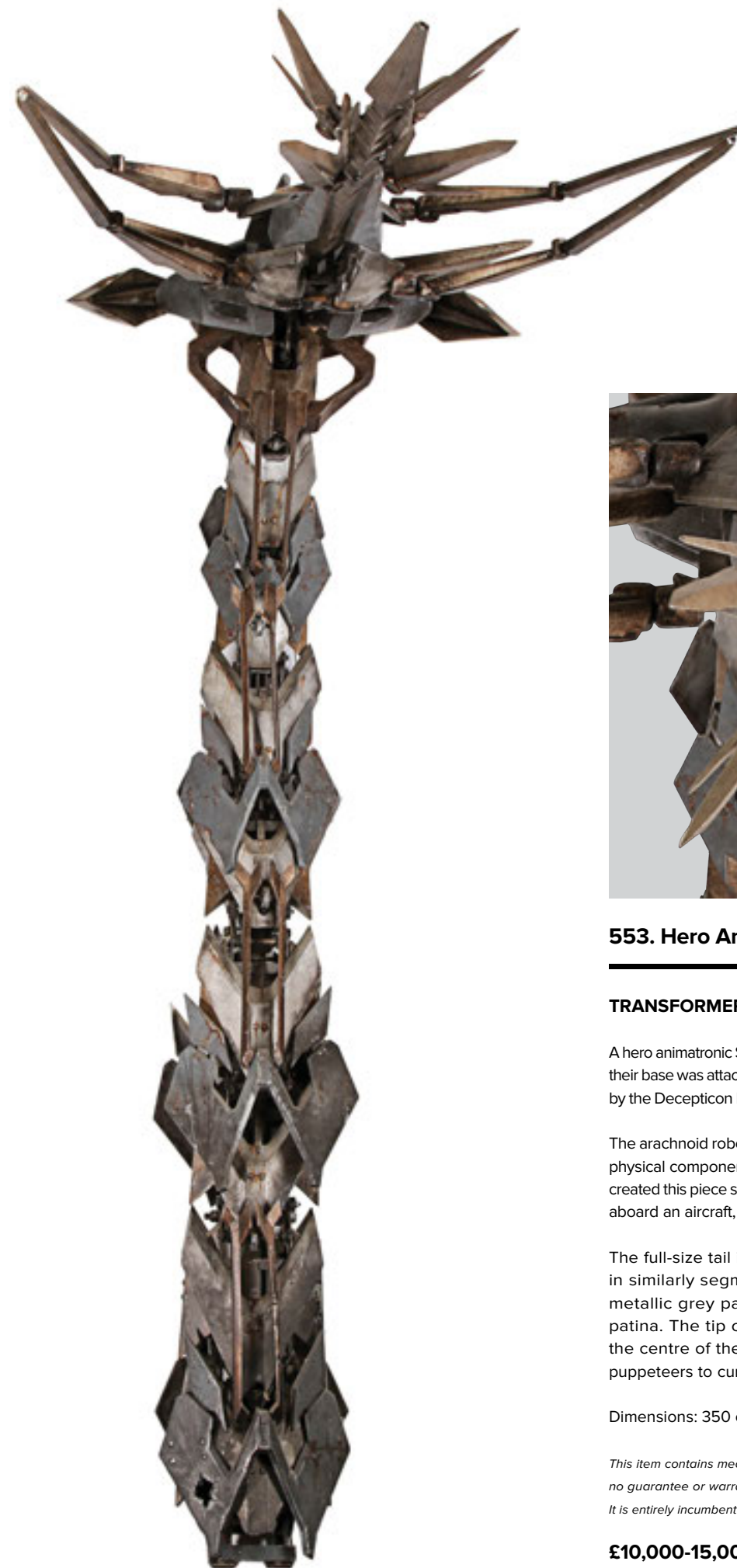

553. Hero Animatronic Scorponok Tail †Δ

TRANSFORMERS (2007)

A hero animatronic Scorponok tail from Michael Bay's sci-fi adventure *Transformers*. After their base was attacked, the surviving soldiers trekked through the Qatar desert, tracked by the Decepticon known as Scorponok, who ambushed them outside a small village.

The arachnid robot was brought to life on screen almost entirely using CGI, the only physical components made were the head and tail. The talented team at KNB EFX created this piece specially for the scene in which the tail was recovered and examined aboard an aircraft, momentarily reanimating and attacking the soldiers once again.

The full-size tail is built around multiple fastened steel segments, covered in similarly segmented fibreglass armour-plating that is decorated with metallic grey paint, dressed with rivets, and given scuffs and an aged patina. The tip of the tail features pointed mandibles. Running through the centre of the rig are lengths of steel cable and rope that allowed the puppeteers to curl and twitch the tail on set. It remains in very good condition.

Dimensions: 350 cm x 85 cm (138" x 34")

This item contains mechanical components. While every effort is made to describe them accurately, no guarantee or warranty is made as to the functionality, lifespan or safety of those components. It is entirely incumbent on the new owner to satisfy themselves as to their safe use and maintenance.

£10,000-15,000



554. Animatronic Scorponok Head M

TRANSFORMERS (2007)

An animatronic Scorponok head from Michael Bay's sci-fi adventure *Transformers*. During Blackout's attack on the US SOCCENT Forward Operations Base in Qatar, his symbiotic counterpart Scorponok was ejected. As the surviving soldiers trekked through the desert to safety, the Decepticon stalked the unit, eventually ambushing them outside a small Bedouin village. The arachnoid robot was brought to life on screen almost entirely using CGI; the only physical components made were the head and tail, built and operated by the talented crew at KNB EFX. It screen-matches to the moment when it raised its head above the sand to spy on the soldiers.

The head is constructed around a steel frame, with assorted hinges, springs and supports, and includes a variety of moving parts controlled with cables: two side panels can move in and out independently; a set of small and large mandibles can be made to pinch together; and the large forward-facing eyes can twitch left and right. Covering the surface are fibreglass panels decorated with rivets, scuffs and other distressed effects to make it appear battle-worn.

It is painted metallic grey and faux bronze, with black accents and splatter effect to add to the aged appearance. "USAF 680360" is stencilled in black paint on the left panel. Sand from the desert film set is still present, and a patch of gaffer tape is adhered to the top of the head, likely to achieve the trickling sand effect when the robot emerged from the ground. The piece remains in very good condition, with a custom-made mounting point to attach it to a secure wall surface.

Dimensions: 68 cm x 60 cm x 71 cm (26" x 23" x 28")

This item contains mechanical components. While every effort is made to describe them accurately, no guarantee or warranty is made as to the functionality, lifespan or safety of those components. It is entirely incumbent on the new owner to satisfy themselves as to their safe use and maintenance.

£20,000-30,000



555. Frenzy Lighting Stand-In Model M**TRANSFORMERS (2007)**

A Frenzy robot lighting stand-in from Michael Bay's sci-fi adventure film *Transformers*. Frenzy is one of the smallest transformers, known for his erratic, hyperactive nature and his skill at espionage. He first appeared when infiltrating Air Force One, hacking the US military mainframe to locate the leader of the evil Decepticons, Megatron. After Mikaela (Megan Fox) decapitated him with an electric saw, he regenerated using the power of the AllSpark and released Megatron from his imprisonment in the ice.

The robots in the movie were brought to life using a combination of CGI and practical props, including this life-size model of Frenzy, created by the talented team at KNB EFX, most likely for use as a lighting stand-in. The components are constructed from hard rubber and resin with a metal internal armature. The model is decorated in assorted metallic shades of paint. There is evidence of repairs to the robot using hot glue, and it comes supported on a custom-made display stand.

Dimensions: 40 cm x 60 cm x 119 cm (15 ¾" x 23 ½" x 47")

£10,000-15,000

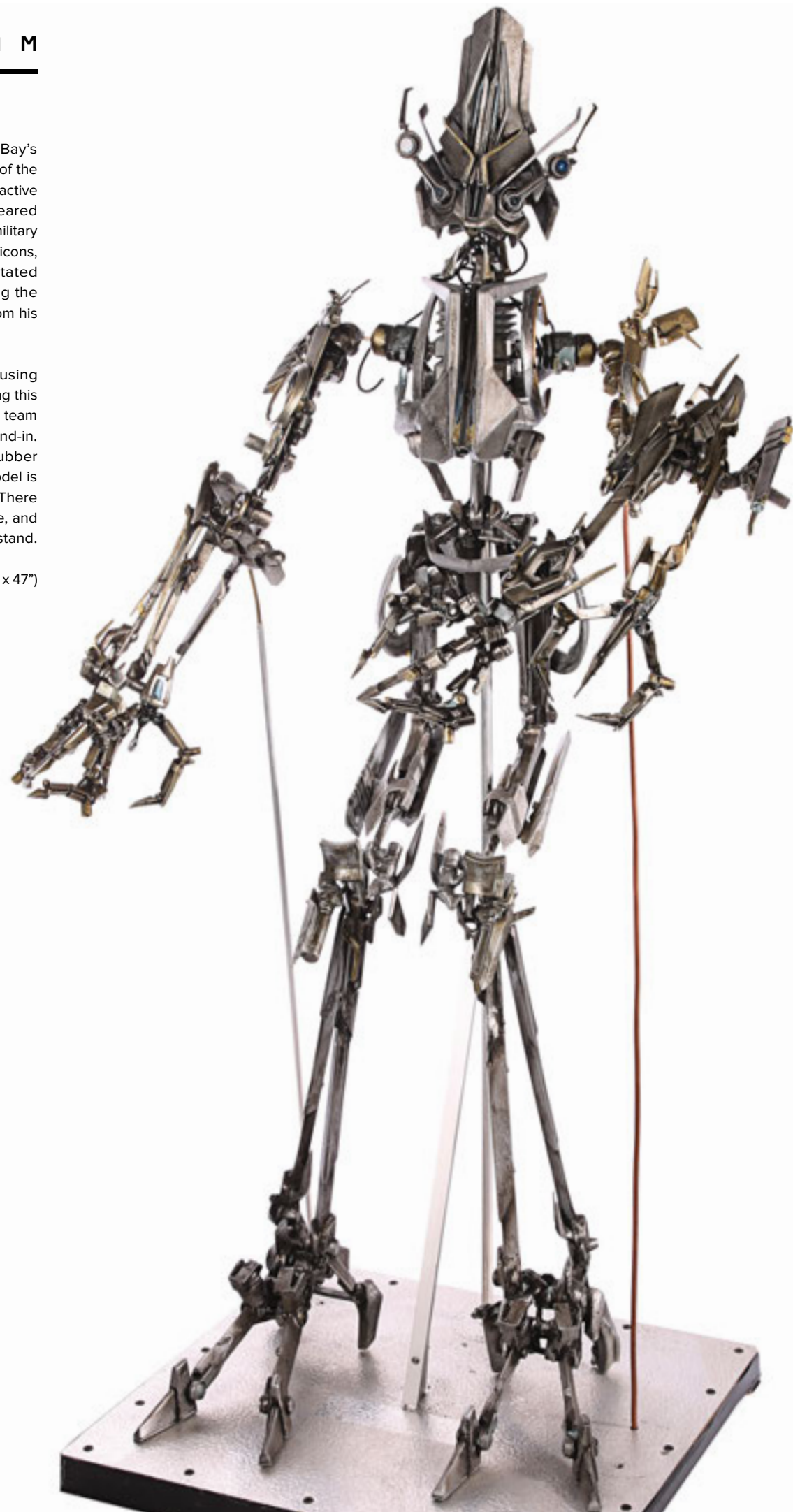
**556. Alice (Isabel Lucas) Decepticon Pretender Rod Puppet M****TRANSFORMERS: REVENGE OF THE FALLEN (2009)**

A rod puppet of Alice (Isabel Lucas) in Decepticon form from Michael Bay's sci-fi adventure sequel *Transformers: Revenge of the Fallen*. After the events of the first *Transformers*, Sam Witwicky (Shia LaBeouf) tried to return to a normal life and went to college. Alice (Isabel Lucas), a Decepticon Pretender, impersonated a student to try and capture Sam on campus. Following several failed attempts to get Sam alone, she seduced him in his dorm room, transforming into her robotic form. When Mikaela (Megan Fox) interrupted the attack, a dramatic chase through the campus ensued.

The robots in the movie were brought to life using a combination of CGI and practical props, the latter created by the talented team at KNB EFX. This puppet was specially created for a scene inside the car during the chase, as director Michael Bay did not want to use CGI for that shot. Ultimately, however, that particular moment did not make it to the final cut.

The piece consists of the chest and head only, built around a steel internal armature supported by a large central metal pole and three rods, allowing the head and shoulders to be lightly moved and posed. Covering the frame are resin components in assorted aggressive shapes, painted metallic grey to resemble metal.

Attached to the head is a volume of Medusa-style hair, a design element added due to the small head needing to look more intimidating. The hair is made of wire in a braided sheath, wrapped with grey-painted plastic, with some strands ending in small arrowhead shapes. The robot's eyes have pink lenses, a deviation from the blue seen in the finished film. It remains in very good condition.

Dimensions: 47 cm x 42 cm x 82 cm (18 ½" x 16 ½" x 32")

£10,000-15,000



557. Achilles' (Brad Pitt) Hero Sword M**TROY (2004)**

Achilles' (Brad Pitt) hero sword from Wolfgang Petersen's mythical epic *Troy*. Achilles wielded his sword throughout the film, using it to brutal effect during his efficient despatch of Boagrius (Nathan Jones) in the opening scenes, as well as in his battles against the Trojan Apollonians and the vicious duel with Hector (Eric Bana).

This is the hero version of this spectacular weapon, used for close-up shots and made from heavyweight materials to the highest standards. The sword blade forms a delicate curved-leaf shape. It is made of solid bronze and decorated with curved inlays coming down from the black, solid-cast resin handle. There are holes to each corner of the grip giving the illusion of rivets. A raised ridge runs down the centre of the blade to just above the tip, and a verdigris patina has been skillfully applied to the handle and base of the blade, to imply age and corrosion. It comes with a letter of inspection from *Troy*'s on-set armourer.

Dimensions: 72 cm x 9 cm x 5 cm (28 1/2" x 3 1/2" x 2")

£8,000-12,000

**558. Production-Used Clapperboard M****TROY (2004)**

A production-used clapperboard from Wolfgang Petersen's mythical epic *Troy*. The clapperboard consists of an acrylic plate with a wooden clapperstick affixed to the top. Used by the 'A' camera unit during filming, the production title "*Troy*" and the names of the director Wolfgang Petersen and cinematographer Roger Pratt are all engraved on the clapperboard in black.

It displays three fields, for scene, slate and take, which have been filled in with black marker. Dated 14th June 2003, the piece was last used for an interior shot during a night shoot. The acrylic shows minor scratches and the clapperstick displays scuff marks and paint wear from production use.

Dimensions: 3 cm x 28 cm x 24 cm (1 1/4" x 11" x 9 1/2")

£1,000-2,000

**559. Paris' (Orlando Bloom) Bow, Quiver and Arrows M****TROY (2004)**

Paris' (Orlando Bloom) bow, quiver and arrows from Wolfgang Petersen's mythical epic *Troy*. Paris used his weapon numerous times during the climatic scenes of the film, most notably as he shot and killed the legendary Greek warrior Achilles (Brad Pitt).

The bow is constructed from wood covered in vellum, with stitching running down the underside. Stamped black hieroglyphs adorn the body and a dark green leather grip with hand-stitched detailing is adhered between the limbs. The ends of the longbow are finished in faux-gold paint and resemble a bird, displaying a black 'beak', and a high-tension bowstring is securely attached.

Made from black leather, the shaped quiver features decorative cream leather pieces with hand-stitching that matches the bow's aesthetic. Attached to the quiver is a thin leather strap, and one side features a decorative pouch with an incorporated scale pattern. A gold-coloured wooden ring is adhered near the top.

A set of six wooden arrows resides within the quiver, with darkened blunt ends where the head would have been attached. The arrows display light grey fletching wrapped with thread. A decorative padded strip is missing from the quiver's strap and the leather on the quiver shows intentional distressing. The hieroglyphs have become faded over time and the lot displays wear from production use, notably on the ends of the bow.

Dimensions: 164 cm x 20 cm x 10 cm (64 3/4" x 8" x 4")

£6,000-8,000



560. Bill Harding's (Bill Paxton) Costume Ω

TWISTER (1996)

Bill Harding's (Bill Paxton) costume from Jan de Bont's action drama *Twister*. Bill wore his tan jacket and jeans at the beginning of the film when he brought divorce papers to his ex, Jo (Helen Hunt). The costume includes Bill's jacket, dress shirt, and jeans.

The jacket is made by Donna Karan, and has a tan-and-brown crosshatch pattern. The long-sleeve dress shirt is made by Anto, featuring a designer label at the neck that reads "BP 1995". The jeans are made by Lee, and are a pepper stonewash colour. Paired with the costume is a production wardrobe tag that reads "Bill Paxton as Bill - 1 - Scn 28-41". The costume shows minor wear due to production use, but remains in very fine condition.

£2,000-3,000

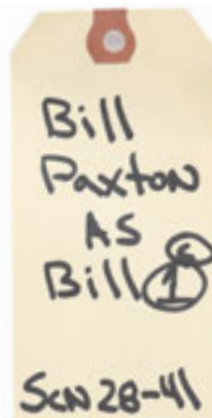

561. Col. Paul Foster's (Michael Billington) SHADO Rifle M

UFO (TV SERIES, 1970 - 1973)

Colonel Paul Foster's (Michael Billington) SHADO rifle from the British sci-fi series *UFO*. Colonel Foster grabbed his rifle when he attempted to kill Commander Ed Straker (Ed Bishop) after he was exposed to a mind-altering implant in the seventh episode of the first series, titled "Kill Straker!"

The rifle was created by noted special effects technician, Derek Meddings. It is made from a combination of wood and resin components finished in black, with a faux-silver metal barrel added to the front to create a futuristic aesthetic to the piece. Cast-in detailing decorates the grip and a long brown leather strap is attached via metal mounts. The trigger features a small button device which

would have been used to produce pyrotechnic effects on set; however, it no longer functions. The barrel displays an indentation on top where a separate sight piece used to be attached, and the weapon shows scratches and paint wear, most notably on the sight. Dimensions: 103 cm x 5 cm x 18 cm (40 ¾" x 2" x 7 ¼")

Ownership of the stunt rifle in this lot is restricted for UK residents to registered re-enactors, galleries or individuals in film, television or theatre production. Please enquire for further details. It is solely the buyer's responsibility to check, prior to bidding, the legal status of this prop within their own country and its importation therein.

£3,000-5,000



562. Violet's (Milla Jovovich) End-Scene Costume †

ULTRAVIOLET (2006)

Violet's (Milla Jovovich) end-scene costume from Kurt Wimmer's sci-fi action film *Ultraviolet*. Violet wore her costume when she fought off numerous guards to rescue Six (Cameron Bright) and battled Daxus (Nick Chinlund).

The red costume consists of a leather jacket, a Lycra zip-up top, a pair of trousers with decorative leather panels, gloves, and knee-high heeled boots. Sections of nylon and satin-like fabric have been incorporated into the jacket, with four plastic poppers adhered to the inside of the collar and outside of the top. The inside of the jacket and waistband are labelled "M" for Milla, the boots display the letter "Y" and the gloves feature the text "Y Double" for Youlia Galenko, Jovovich's stunt double. The costume displays multiple marks and has been intentionally distressed, with paint applied to produce a burnt appearance.

£1,500-2,500



UFO (TV SERIES, 1970 - 1973)

Colonel Paul Foster's (Michael Billington) SHADO rifle from the British sci-fi series *UFO*. Colonel Foster grabbed his rifle when he attempted to kill Commander Ed Straker (Ed Bishop) after he was exposed to a mind-altering implant in the seventh episode of the first series, titled "Kill Straker!"

The rifle was created by noted special effects technician, Derek Meddings. It is made from a combination of wood and resin components finished in black, with a faux-silver metal barrel added to the front to create a futuristic aesthetic to the piece. Cast-in detailing decorates the grip and a long brown leather strap is attached via metal mounts. The trigger features a small button device which

would have been used to produce pyrotechnic effects on set; however, it no longer functions. The barrel displays an indentation on top where a separate sight piece used to be attached, and the weapon shows scratches and paint wear, most notably on the sight. Dimensions: 103 cm x 5 cm x 18 cm (40 ¾" x 2" x 7 ¼")

Ownership of the stunt rifle in this lot is restricted for UK residents to registered re-enactors, galleries or individuals in film, television or theatre production. Please enquire for further details. It is solely the buyer's responsibility to check, prior to bidding, the legal status of this prop within their own country and its importation therein.

£3,000-5,000



563. Production-Used Clapperboard M

UNBREAKABLE (2000)

A clapperboard from M. Night Shyamalan's superhero thriller *Unbreakable*. Used by the 'A' camera unit during filming, the clapperboard is made of acrylic with a wooden clapperstick affixed to the top. Three red outlined boxes feature on the slate, dividing it into fields for roll, scene and take. The production title "*Unbreakable*" is engraved in black across the middle and the names of the director M. Night Shyamalan and director of photography Eduardo Serra are highlighted in red below.

The fields display faded text which would have been applied using black marker during filming. Signs of production use are present on the piece, including scuff marks and tape residue on the back of the clapperstick, and minor surface scratches on the acrylic.

Dimensions: 4 cm x 28 cm x 24 cm (1 ¾" x 11" x 9 ½")

£1,500-2,000

564. Lucian's (Michael Sheen) Necklace M**UNDERWORLD: EVOLUTION (2006)**

Lucian's (Michael Sheen) necklace from Len Wiseman's fantasy horror *Underworld: Evolution*. After his demise in the first film, the Lycan leader's necklace became pivotal to the plot of the sequel. Created by Selene's father (Andrew Kavasas), it provided the key to the prison that held the forsaken original werewolf, William.

Constructed from cast metal, the pendant has a distressed faux-gold paint finish and features a decorative cross pattern with a plastic green stone at the centre. It hangs on a metal-link chain secured to a length of brown leather. The necklace shows evidence of wear from its time spent on the production, including a slight pink paint residue left in the recesses and a length of tape secured to the reverse of the pendant. Dimensions (laid out): 43 cm x 6 cm x 1.5 cm (17" x 2 1/2" x 1/2")

**£1,000-1,500****565. Selene's (Kate Beckinsale) Hero Walther P99 M****UNDERWORLD (2003)**

Selene's (Kate Beckinsale) hero Walther P99 from Len Wiseman's fantasy-horror *Underworld*. One of her favoured weapons, the Death Dealer carried her pistol throughout the film as the age-old conflict raged between Vampires and Lycans. Selene used her weapon when she let off steam at the shooting range, firing the newly developed liquid silver rounds.

Displaying a two-tone finish with a black polymer frame and silver-coloured "Titanium" slide, the 9mm Walther P99 pistol features various original "Walther" and "P99" markings on the slide and grip. Fitted to the bottom of the barrel is an ambidextrous BA-5 laser unit with switches on either side, which remains in a functional state. The firearm has been sympathetically deactivated with the slide, magazine release and trigger still functional. The weapon shows surface scratches throughout and minor wear to the finish, from its time spent on the production.

Dimensions: 18 cm x 3 cm x 13 cm (7" x 1 1/4" x 5")

This weapon has been permanently and sympathetically deactivated to UK legal requirements (at the time of deactivation) and no longer retains any functional capacity to fire. It is accompanied by a proof house certificate of deactivation. The weapon may require further deactivation and re-certification prior to shipping at the buyers expense, based upon current legislation, buyer and weapon location. It is solely the buyer's responsibility to check, prior to bidding, the legal status of this weapon within their own country and the importation thereof.

This item contains electronic components. While every effort has been made to describe them accurately, no guarantee or warranty is made as to the functionality, lifespan or safety of those components. It is entirely incumbent on the new owner to satisfy themselves as to their safe use and maintenance.

£4,000-6,000**566. John's (Richard Herd) Commander Uniform †Δ****V (TV SERIES, 1983 - 1985) / V: THE FINAL BATTLE (TV MINISERIES, 1984)**

John's (Richard Herd) commander uniform from Kenneth Johnson's sci-fi television series *V*. John wore his uniform throughout the series as he led the Visitor fleet, as well as during the miniseries *V: The Final Battle*.

The uniform is composed of a jumpsuit with a pair of bracers. Made from burnt-orange cotton, the jumpsuit features multiple pockets and metal popper fastenings adorning the front of the garment. Constructed from orange quilted suede fabric, the bracers are decorated with lines of black trim and have orange Velcro fastenings.

A label featuring the handwritten text "42, John" is adhered to the inside of the uniform's neckline. Sewn to the lining of a bracer is a white label displaying "Warner Bros. Pictures Inc. label" embroidered in red, and the text "Dick Herd". Unfinished edges on the uniform have begun to fray over time and the piece displays minor marks from production use.

£3,000-5,000**567. V Mask, Hat and Wig M****V FOR VENDETTA (2005)**

A V mask, hat and wig from James McTeigue's dystopian political thriller *V for Vendetta*. Members of the public wore masks, hats and wigs during the final scenes of the film, when they staged a mass uprising against the government in support of V (Hugo Weaving).

Made from durable plastic, the Guy Fawkes mask features an upturned moustache, a thin beard and rosy cheeks. A piece of black elastic is attached to the mask and pieces of foam are adhered to its interior for comfort. The hat is made from black felt, and a synthetic black wig is adhered to the back. The set is displayed on a custom-made stand which features the film's title artwork in red. Displaying light wear from production use, the lot is accompanied by two certificates of authenticity from Warner Bros.

Dimensions (on display): 39 cm x 39 cm x 53 cm (15 1/2" x 15 1/2" x 21")

£2,000-3,000

568. Colonel Claus von Stauffenberg's (Tom Cruise) Cap †Δ

VALKYRIE (2008)

Colonel Claus von Stauffenberg's (Tom Cruise) cap from Bryan Singer's World War Two thriller *Valkyrie*. Von Stauffenberg held and wore his cap throughout the film as he joined a group of disaffected officers who conspired to assassinate Adolf Hitler.

The cap is made from feldgrau (field-grey) cotton, with a dark green felt band and a black plastic peak. Lines of maroon piping adorn the piece and dual faux-silver knotted braid runs across the peak. The front is decorated with a metal German eagle insignia and a faux-silver oak-leaf emblem surrounding a central cockade. The interior is lined with green synthetic fabric and features a brown leather sweatband. A label reading "T.C Hero 2" is adhered to the inside of the sweatband. The cap shows signs of production use, including corrosion on the metal emblems and minor marks on the sweatband.

Dimensions: 24 cm x 23 cm x 17 cm (9 ½" x 9" x 6 ¾")

£1,000-1,500



569. 2nd Unit Clapperboard M

VAN HELSING (2004)

A 2nd unit clapperboard crew gift from Stephen Sommers' fantasy adventure film *Van Helsing*. The clapperboard consists of an acrylic slate with a wooden clapper. The slate is backed with vinyl, on which are printed boxes for information, including roll, scene, date and take. The movie title is incorporated into a lightning-themed banner above the second unit director "Greg Michael", camera "Josh Bleibtreu" and "2nd Unit" in red. Unused during production, the slate has some ink residue from where fields were filled in for aesthetic purposes.

Dimensions: 3 cm x 28 cm x 24 cm (1 ¼" x 11" x 9 ½")

£100-150



570. Van Helsing (Hugh Jackman) Wanted Poster M

VAN HELSING (2004)

A Wanted poster from Stephen Sommers' fantasy-adventure film *Van Helsing*. Van Helsing (Hugh Jackman) encounters posters wanting him dead or alive while hunting down the murderous Mr Hyde (Robbie Coltrane) in Paris.

The poster is printed in black ink on thick, pale brown paper with brown paint added to look like watermarks. The sheet reads "POLICE DEPARTMENT — WANTED POSTER — DEAD OR ALIVE" in French with a sketch of the vampire hunter in his distinctive hat and mask, as well as his name, crime and the reward. It is backed on a foam board for presentation purposes, with a hole at the top and some slight foxing to the edges.

Dimensions: 0.5 cm x 41 cm x 64 cm (½" x 16" x 25 ¼")

£300-500



571. Vatican Secret Order Stake and Crucifixes M

VAN HELSING (2004)

A collection of crucifixes and a stake from Stephen Sommers' fantasy-adventure film *Van Helsing*. The Vatican Secret Order armoury was well stocked with vampire-hunting devices while Van Helsing (Hugh Jackman) briefed Friar Carl (David Wenham) on their mission there, before taking a variety with them to Transylvania.

The set consists of a rubber crucifix stake, decorated to resemble wood; a crucifix cast from resin and painted faux silver; and a long stake made of solid rubber, painted to look like wood with embellishments in faux silver. Each remains in good condition, with a slight curve to the stake.

Dimensions (largest): 58cm x 5 cm x 5 cm (22 ¾" x 2" x 2")

£600-800



572. Dracula and Van Helsing Gentle Giant Studios Reference Maquettes M

VAN HELSING (2004)

A pair of reference maquettes created by visual effects company Gentle Giant Studios for the characters in Stephen Sommers' fantasy-adventure film *Van Helsing*. These statues were digitally sculpted by the team at Gentle Giant Studios as a reference during the making of the movie.

features the film's title, a stake and a small plaque with the Universal logo and the wording "Official reference maquette sculpted by Gentle Giant Studios". Both statues remain in very good condition.

The pair comprises a statue of the transformed Van Helsing in his werewolf form and Dracula in his Hellbeast form. They are made from hand-painted polystone resin, and each character is presented on a graveyard-themed base, which

Dimensions (Dracula): 29 cm x 49 cm x 58 cm (11 ¾" x 19 ½" x 23"); (Van Helsing): 19 cm x 26 cm x 19 cm (7 ½" x 10 ¼" x 7 ½")

£1,500-2,500



573. Werewolf Antiserum Syringe M

VAN HELSING (2004)

A syringe of werewolf antiserum from Stephen Sommers' fantasy-adventure film *Van Helsing*. After Van Helsing (Hugh Jackman) is bitten by the Wolfman (Will Kemp) he discovers Dracula (Richard Roxburgh) has a cure, which companions Anna (Kate Beckinsale) and Carl (David Wenham) force Igor (Kevin J. O'Connor) to lead them to.

Made from machined metal, the antiserum syringe is decorated to look like gold. Inside, a clear acrylic tube is painted vivid red to represent the serum, with two bands of glyphs above and below the serum vial. The syringe needle and plunger are static but can be adjusted via a small screw. The needle is slightly curved and some of the golden paint is scuffed and flaking. However, the syringe remains in otherwise good condition.

Dimensions: 34cm x 3 cm x 3 cm (13 1/2" x 1 1/4" x 1 1/4")

£1,500-2,500

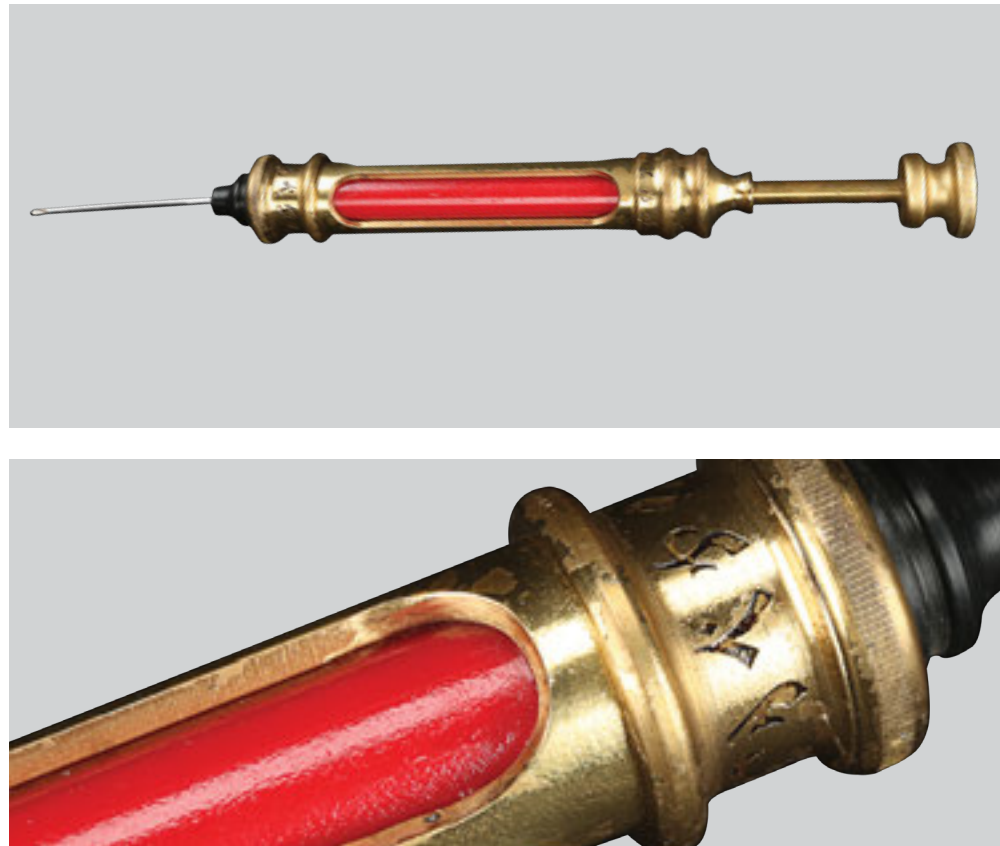

574. Van Helsing's (Hugh Jackman) Stunt Crossbow M

VAN HELSING (2004)

Van Helsing's (Hugh Jackman) stunt crossbow from Stephen Sommers' fantasy-adventure film *Van Helsing*. Van Helsing was given his gas-powered automatic crossbow by its inventor, Friar Carl (David Wenham), and used it in his battle with the brides of Dracula (Richard Roxburgh), killing the vampire Marishka (Josie Maran) after dipping its arrows in holy water. Stunt versions were used during high-action sequences, when it was unsafe or unnecessary to risk damage to the functioning hero weapon.

Cast entirely in solid rubber, the bow is painted to resemble metal and brass, featuring an ornate grip with a ram's head embellishment, a static arrow cartridge beneath and a gas canister at the back. The bow arms fold into the side of the main body, with rope, also cast from rubber, strung between them. The arms have warped slightly with age and some paint has chipped away. Dimensions (open): 93 cm x 73 cm x 26 cm (36 1/2" x 28 3/4" x 10 1/4")

£3,000-5,000



575. Van Helsing's (Hugh Jackman) Hero SFX Tojo Blades Weapon M

VAN HELSING (2004)

Van Helsing's (Hugh Jackman) hero SFX Tojo Blades weapon from Stephen Sommers' fantasy-adventure film *Van Helsing*. Van Helsing used his distinctive spinning weapons to great effect against Mr Hyde (Robbie Coltrane) in Paris, and later during the carriage chase through Transylvania. He also used them to immobilise Dracula's (Richard Roxburgh) faithful servant Igor (Kevin J. O'Connor). Marks on the head of the blades screen match to the sequence in Paris.

The device, fixed in its "open" position, is constructed from aluminium with brass components. The side-mounted spinning head has eight blades, with jagged and smooth edges, placed equally around the circumference. On each side of the head is a wide, decorative brass ring incorporating raised Chinese characters.

The ergonomic handle houses the mechanism which spins the blades, operated by a pump-action spring-loaded trigger. The grip features a Catholic-themed inlay, decorated to look like stained wood. The weapon has intentional scuffs and marks to the blades and head, to make it appear well used. Dimensions: 10 cm x 27 cm x 27cm (4" x 10 1/2" x 10 1/2")

As this item contains mechanical components, every effort has been made to describe them accurately; however no guarantee or warranty is made as to functionality, lifespan or safety of those components. It is entirely incumbent on the new owner to satisfy themselves as to their safe use and maintenance.

£8,000-12,000



576. Van Helsing's (Hugh Jackman) Hero Pistol M**VAN HELSING (2004)**

Van Helsing's (Hugh Jackman) hero pistol from Stephen Sommers' fantasy-adventure film *Van Helsing*. Van Helsing carried his pistols throughout the film, using them to fight Mr Hyde (Robbie Coltrane), the Wolfman (Will Kemp), Frankenstein's Monster (Shuler Hensley) and a sinister Transylvanian undertaker.

The entirely custom-made gun, modelled on a revolver, is cast from grey metal with a painted black tarnish and machined brass embellishments. The barrel incorporates etched Chinese symbols on both faces, while the black grips are made of resin and feature a Holy Cross painted with red and gold-coloured paint.

Intended to replicate the action of the Webley-Fosbery .455 revolver, the barrel can be pulled back to demonstrate the retracting motion. The cylinder rotates

and contains five bullets that are fixed in place. It also has a functioning trigger and hammer mechanism. A brass cap fixed to the butt of the weapon twists off to reveal where a CO2 canister — used to activate the gun's movements — was hidden during filming. It remains in a very good, untested condition.

Dimensions: 33 cm x 5 cm x 18 cm (13" x 2" x 7")

As this item contains mechanical components, every effort has been made to describe them accurately. However, no guarantee or warranty is made as to the functionality, lifespan or safety of those components. It is entirely incumbent on the new owner to satisfy themselves as to their safe use and maintenance.

£10,000-15,000

**577. Van Helsing's (Hugh Jackman) Hero Grappling Gun M****VAN HELSING (2004)**

Van Helsing's (Hugh Jackman) hero grappling gun from Stephen Sommers' fantasy-adventure film *Van Helsing*. The legendary vampire hunter used his grappling gun when battling the murderous Mr. Hyde (Robbie Coltrane) atop the Notre-Dame cathedral in Paris, and during his escape with Anna Valerious (Kate Beckinsale) from Castle Frankenstein.

The weapon is made from a combination of machined metal and brass, decorated to appear weathered and well-used. Inside the barrel is a cast-resin grappling hook with four fold-out prongs, painted grey to resemble metal. A sight folds up from the top and there is a mock safety on the left side. Below the barrel is a static drum of rope. The grip is made from resin painted black, and features a cast-in Holy Cross decorated with red and brass-coloured paint.

Drawing the barrel forwards cocks it in place, and a pull of the trigger releases the barrel back with a snap to reveal the nose of the grappling hook. There are scuffs to the grip revealing the resin beneath, but the grappling gun remains in otherwise very good condition.

Dimensions: 30 cm x 5 cm x 20 cm (11 ¾" x 2" x 8")

As this item contains mechanical components, every effort has been made to describe them accurately; however no guarantee or warranty is made as to functionality, lifespan or safety of those components. It is entirely incumbent on the new owner to satisfy themselves as to their safe use and maintenance.

£10,000-15,000



578. Hutch Stop-Motion Puppet Head Ω**WALLACE AND GROMIT: THE CURSE OF THE WERE-RABBIT (2005)**

A Hutch stop-motion puppet head from Steve Box and Nick Park's animated comedy *Wallace and Gromit: The Curse of the Were-Rabbit*. Hutch was a rabbit imbued with Wallace's intelligence, after an accident occurred when the cheese-loving inventor put the creature through his Mind Manipulation-O-Matic machine.

The head is made of clay over a metal armature, and resembles a grinning rabbit with two buck teeth. The stop-motion head shows some wear to the clay due to age, with breaks to the material at the ears. The piece remains in good overall condition.

Dimensions: 10 cm x 6 cm x 4 cm (3 ¾" x 2 ½" x 1 ½")

£800-1,000

579. Mitchell NC Camera US**WALT DISNEY STUDIOS**

A classic Mitchell 35mm motion picture camera used by Walt Disney Studios for various productions. Developed in 1932 by Mitchell Corporation, the NC camera became a standard piece of equipment for Hollywood movie productions. Mitchell records indicate that this specific NC240 camera was sold to "Walt Disney" on 30 November, 1944. It was likely used on Disney live-action films of the 1940s to 1960s, before other makes of camera took over.

This vintage Mitchell NC camera, serial number 240, includes a 400' Mitchell film magazine and a Mitchell motor. The motor is paired with its original carrying case, marked for the Walt Disney camera department. The camera was later modified for visual effects usage with an updated lens mount. It is no longer on its rack-over base, is untested condition, shows wear to the outer finish from use and is in fair overall condition. Dimensions (camera assembled): 38 cm x 33 cm x 43 cm (15" x 13" x 17"); (motor case): 32 cm x 21.5 cm x 21.5 cm (12 ½" x 8 ½" x 8 ½")

This lot contains electronics components. While every effort is made to describe them accurately, no guarantee or warranty is made as to the functionality, lifespan or safety of those components. It is entirely incumbent on the new owner to satisfy themselves as to their safe use and maintenance.

£2,000-3,000

580. Animator's Desk US**WALT DISNEY STUDIOS**

An animator's desk used by Walt Disney Studios for various productions. This desk is based on a design originally conceived by German industrial designer Kem Weber. Weber was hired by Walt Disney to design and furnish the Disney Animation Studios in Burbank, California. When the studio was redesigned during the 1990s, a new version of the desk was produced, taking heavy influence from Weber's style.

This desk is of the second generation, constructed during the Disney Renaissance of the 1990s. It is made of wood, with a honey maple finish. A custom light table is built into the centre of the desk and is able to be easily manipulated with the turn of a lever. The functionality of the desk is bolstered with drawers designed specifically for the storage of animation tools and materials. A Disney barcode is present on the right side of the drawer compartment. The desk shows some wear from use and storage, including chips to the wood on the side of the left panel and light scratching throughout. However, this lot is in fair overall condition. Dimensions: 183 cm x 70 cm x 141 cm (72" x 27 ½" x 55 ½")

£3,000-5,000

**581. Fox's (Angelina Jolie) Hero Pistol** M**WANTED (2008)**

Fox's (Angelina Jolie) hero pistol from Timur Bekmambetov's action thriller *Wanted*. Fox used her pistol in multiple scenes throughout the film as she trained Wesley (James McAvoy) to become part of the Fraternity, the band of assassins his father worked for. She notably used her weapon when she first met Wesley in a pharmacy and began a shoot-out with Cross (Thomas Kretschmann).

Based on a Safari Arms Matchmaster — a copy of the famous Colt 1911 — the weapon features a nickel finish and carries the serial number "S6904", with swirling patterns decorating the slide and main body. Ivory Resin grips painted to resemble ivory are attached to both sides of the weapon and feature engraved patterns with black shading. Custom components have been added, including a compensator fitted to the end of the barrel and an extended magazine.

The firearm has been sympathetically deactivated, with the slide, hammer, safeties, magazine release and trigger still functional, and is accompanied by a deactivation certificate. The pistol shows minor paint wear on the ivory panels and trigger, and scratches on the top edge.

Dimensions: 26 cm x 5 cm x 18 cm (10 ¼" x 2" x 7 ¼")

This weapon has been permanently and sympathetically deactivated to UK legal requirements (at the time of deactivation) and no longer retains any functional capacity to fire. It is accompanied by a proof house certificate of deactivation. The weapon may require further deactivation and re-certification prior to shipping at the buyers expense, based upon current legislation, buyer and weapon location. It is solely the buyer's responsibility to check, prior to bidding, the legal status of this weapon within their own country and the importation thereof.

£5,000-7,000

**582. Steven Spielberg's Director's Chair** M**WAR HORSE (2011)**

Steven Spielberg's director's chair from his Academy Award-nominated war drama *War Horse*. Director's chairs were used during the production by cast and crew members, with this chair designated for the film's director and producer, Steven Spielberg.

The frame of the foldable chair is made of wood, with a black linen padded seat and back rest. Pockets are attached to the right armrest and to the underside of the chair, with the latter accessible by lifting the seat. The removable chair back is also made from black linen and reads "Steven Spielberg" on one side and "War Horse" on the other in embroidered faux-gold text. The chair displays signs of wear, including a missing screw on the left armrest and two rubber feet no longer present.

Dimensions (unfolded): 70 cm x 65 cm x 116 cm (27 ½" x 25 ¾" x 45 ¾")

£2,000-3,000



583. Background Freddy Krueger (Robert Englund) Mask Ω

WES CRAVEN'S NEW NIGHTMARE (1994)

A background Freddy Krueger (Robert Englund) mask from horror sequel *Wes Craven's New Nightmare*. In the real world, original *A Nightmare on Elm Street* actress Heather Langencamp (as herself) was targeted by Krueger (Robert Englund) as director Wes Craven (playing himself) began production on a new sequel. This mask was made for the freeway sequence, when Heather's son, Dylan (Miko Hughes), crossed the freeway and saw a row of Freddy's behind a median strip.

The Freddy mask is made of slip latex, and utilises Craven's updated look for the demonic killer, with larger patches of skin tissue still present. There are holes at the eyes, nose, mouth and ears, and the back of the mask features a slit for easy access. Handwritten inside the mask in black ink is "#23". The mask remains in very fine condition.

Dimensions: 24 cm x 27 cm x 37 cm (9 1/2" x 10 1/2" x 14 1/2")

£4,000-6,000



585. Hand-Painted Roger Rabbit Animation Cel M

WHO FRAMED ROGER RABBIT (1988)

A hand-painted cel from Robert Zemeckis' Oscar®-winning detective comedy *Who Framed Roger Rabbit*. Cels were used to animate the cartoon characters throughout the film, including the scene in Eddie Valiant's (Bob Hoskins) apartment where Roger beseeches him for his help in proving his innocence.

The cel consists of an image of Roger standing on Valiant's bed. Roger is hand-painted with acrylic on transparent acetate that is laid over a shot of filmed footage. It is displayed in a black glass-fronted frame, surrounded by a white card mount with an original cream seal and a small plaque detailing the film title and release year.

Accompanying the cel is a letter of authenticity from Walt Disney Studios as well as a set of six lobby cards — one featuring the same image. The frame shows minor scratches and wear from storage.

Dimensions: 3 cm x 65.5 cm x 50 cm (1 1/4" x 25 3/4" x 19 3/4")

£1,000-1,500

586. Acme Warehouse Brick M

WHO FRAMED ROGER RABBIT (1988)

An Acme warehouse brick from Robert Zemeckis' Oscar®-winning detective comedy *Who Framed Roger Rabbit*. During the warehouse scenes at the film's climax, a "Ton of Bricks" was dropped on Roger Rabbit's head to aid Judge Doom (Christopher Lloyd) in his capture of the heroic toon. The bricks also fell from the warehouse wall when the Weasel Gang broke through to Toontown.

The brick is made of foam rubber and has a brown-red paint finish with rough edges, pits and cracks for a realistic effect. There are small air bubbles in the foam rubber, and the brick shows minor surface wear from its time spent in storage. Dimensions: 21.5 cm x 10.5 cm x 6.5 cm (8 1/2" x 4 1/4" x 2 1/2")

£100 - 150



584. Bob Hoskins-Autographed Poster and Crew Jackets M

WHO FRAMED ROGER RABBIT (1988)

Two crew jackets and a poster from Robert Zemeckis' Oscar®-winning detective comedy *Who Framed Roger Rabbit*, which were gifted to the heads of department. The first jacket is made of black fleece and has knitted cuffs and collar, with press-stud fastenings. It is marked size small and features an embroidered illustration of Roger Rabbit on the back. The second jacket matches the style of the first, but has a white-striped cotton lining and is marked size extra-large. It also displays embroidered red text on the front and back.

Accompanying the jackets is a Bob Hoskins-autographed poster (EX condition, adhered to a blue card mount). The jackets show production use, including minor stains.

Dimensions (poster): 39 cm x 53.5 cm (15 1/2" x 21")

£200-300

587. Acme Itching Powder, Bomb and Brick M

WHO FRAMED ROGER RABBIT (1988)

A collection of Acme warehouse items from Robert Zemeckis' Oscar®-winning detective comedy *Who Framed Roger Rabbit*. Cartoonish explosives, bricks and products were used to dress the warehouse, most notably towards the end of the film as Roger and Eddie Valiant (Bob Hoskins) foil Judge Doom's (Christopher Lloyd) Toontown destruction.

Made from cardboard, the Itching Powder box has a cream paper covering with printed text, including Acme labels. The biscuit-foam bomb is painted black with a wooden top and string fuse. It features "BOMB" sprayed in white across the front. The brick is constructed from polystyrene with a pale red paint finish. The props display minor wear from production use, with the brick's paint finish worn and exposing the polystyrene beneath.

Dimensions (Itching Powder): 13 cm x 19.5 cm x 35 cm (5" x 7 3/4" x 13 3/4")

£600-800



588. Acme Bird Seed, Itching Powder and Elephant Pills Boxes M**WHO FRAMED ROGER RABBIT (1988)**

A collection of Acme boxes from Robert Zemeckis' Oscar®-winning detective comedy *Who Framed Roger Rabbit*. Assorted boxes formed the vast stock of products and resources stored within the Acme warehouse for use in cartoon productions.

The set includes three decorated cardboard boxes in varying sizes, with printed paper labels covering their sides. The cartoonish products include "Elephant Pills" on a pink background, "Itching Powder" on cream and "Bird Seed" on yellow. All include "Acme" brand labels. The boxes show minor tears, creases and stains throughout.

Dimensions (largest box): 33.5 cm x 25 cm x 20 cm (13 ¼" x 10" x 8")

£600-800

589. Full-Scale Smart Ass Weasel Stand-In Ω**WHO FRAMED ROGER RABBIT (1988)**

A full-scale Smart Ass Weasel stand-in from Robert Zemeckis' Oscar-winning detective comedy *Who Framed Roger Rabbit*. Made to scale, stand-ins were used during the production to help performers by giving them a physical reference to act against during scenes involving animated characters. This stand-in helped the actors with their performances in scenes featuring the lead weasel of Judge Doom's (Christopher Lloyd) Toon Patrol, most notably when Eddie Valiant (Bob Hoskins) confronted the Smart Ass Weasel in his office while washing his socks and concealing Roger Rabbit.

The stand-in is made of foam with a metal armature skeleton for posing, and is made to scale. The foam shows some deterioration, including cracking, dirtying and slight hardening. However, the piece is in fine overall condition.

Dimensions: 38 cm x 50 cm x 100 cm (15" x 19 ¾" x 39 ¼")

£3,000-5,000

**590. Full-Scale Roger Rabbit Stand-In Ω****WHO FRAMED ROGER RABBIT (1988)**

A full-scale Roger Rabbit stand-in from Robert Zemeckis' Oscar®-winning detective comedy *Who Framed Roger Rabbit*. Made to scale, stand-ins were used during the production to help performers by giving them a physical reference to act against during the scenes involving the Toon rabbit. The stand-in was later replaced with the final animated version of Roger.

Made of foam with a metal armature skeleton for posing, the stand-in stops at Roger Rabbit's waist, with the metal armature emerging from the bottom of the waist. Roger shows evidence of age and production use, including a missing tooth and a tear to the right shoulder. Portions of the foam are slightly dry, but the piece remains in fair overall condition.

Dimensions: 23 cm x 20.5 cm x 129.5 cm (12" x 9" x 51")

£2,000-3,000

**591. General Kael's (Pat Roach) Battle Damaged Mask †****WILLOW (1988)**

General Kael's (Pat Roach) battle damaged mask from Ron Howard's fantasy adventure *Willow*. The leader of the Nockmaar army wore his signature skull mask throughout the film, notably towards the end, when Madmartigan (Val Kilmer) smashed his mask in combat during the siege on Nockmaar Castle.

Made of resin reinforced with fiberglass, the mask is finished to resemble the look of worn bone, with faux-silver foil applied to the jaws, teeth and brows. It features a circular plastic component on the forehead and brown-and-white synthetic hair across the crown and jaw. A comfort pad constructed from foam and rubber is secured to the inside of the forehead. Broken for use in the film's closing scenes, the mask shows two missing front teeth and wear on the foil components. A badge formerly attached to the plastic device is no longer present.

Dimensions: 18 cm x 20 cm x 30 cm (7" x 8" x 12")

£2,000-3,000

592. "Wonkavator" Glass Elevator Production Design Copies M

WILLY WONKA & THE CHOCOLATE FACTORY (1971)

A pair of production design copies from Mel Stuart's fantasy musical *Willy Wonka & the Chocolate Factory*. These two pieces of printed artwork helped to illustrate scenes involving the amazing "Wonkavator" and would have been copied for use by the film's production departments.

hold on inside. The other features the top of the elevator bursting through the factory's glass roof. Well-used, the artwork shows minor wear, with a small tear on the bottom right corner of one piece.

Dimensions (each): 30.5 cm x 40.5 cm (12" x 16")

£600-800

Drawn by art director Harper Goff, the first picture shows Wonka operating the elevator with Charlie, Grandpa Joe, Mike Teevee and Mrs. Teevee attempting to

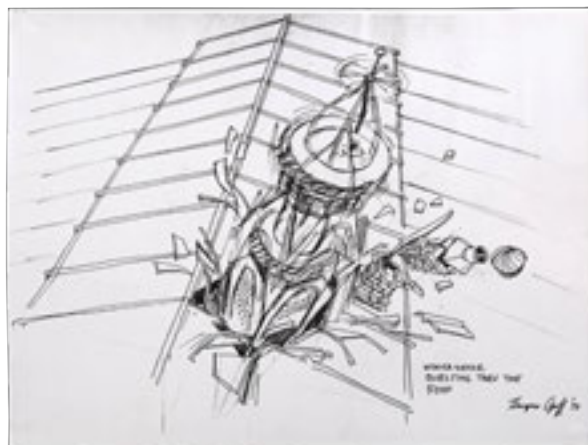

593. Wonka Bar M

WILLY WONKA & THE CHOCOLATE FACTORY (1971)

A Wonka Bar from Mel Stuart's fantasy musical *Willy Wonka & the Chocolate Factory*. Wonka Bars feature throughout this adaptation of Roald Dahl's classic children's story, as Willy Wonka (Gene Wilder) randomly hid five Golden Tickets within the bars' wrappers. It was in such a bar that Charlie Bucket (Peter Ostrum) found his precious ticket and his incredible adventure began.

Props from this beloved film are extremely hard to find, with most destroyed at its Bavarian film studio to allow production to wrap quickly, making way for the immediate filming of *Cabaret*.

The Wonka Bar is accompanied by a letter and photo from one of the actors who portrayed an Oompa Loompa in the film. It is in very good condition, with only a few minor scuffs to the edge and a crease to the top right corner.

Dimensions (Wonka bar): 9 cm x 16 cm x 0.5 cm (3 1/2" x 6" x 1/2")

£8,000-10,000



594. Wolfman (Benicio Del Toro) Transformation Test Bust Ω

THE WOLFMAN (2010)

A Wolfman (Benicio Del Toro) transformation test bust from Joe Johnston's *The Wolfman*. This head was created by Rick Baker's Cinovation studio to propose an approach to a specific transformation sequence in the film. While the transformation scenes were ultimately achieved using CGI, this crucial work established the film's aesthetic early in the production process.

The bust is constructed from a polyfoam core covered with silicone skin. The skin is painted with detail in order to appear as though the character is slowly turning into the Wolfman, and the piece features a set of latex wolf teeth. The bust is presented on a custom-made wooden stand and is in very fine overall condition.

Dimensions (on base): 43 cm x 43 cm x 46 cm (17" x 17" x 18")

£2,000-3,000



595. John Romita Jr. and Duffy Vohland Hand-Drawn Hulk and Wolverine Page One Title Splash UK Reprint Artwork Ω

WOLVERINE / THE MIGHTY WORLD OF MARVEL #199 (1976) / INCREDIBLE HULK #181 (1974)

Hand-drawn page one title splash artwork by John Romita Jr. and Duffy Vohland featuring the Incredible Hulk and Wolverine. This artwork was created in 1976 when *The Incredible Hulk #181* story was reprinted in the UK in *The Mighty World of Marvel #199*. Credited to the original penciller of *The Incredible Hulk #181*, Herb Trimpe, this re-worked splash was pencilled by a young John Romita Jr.

The artwork is drawn in pencil and ink on Bristol board, with the word balloons and synopses pasted on. On the back of the artwork is a Marvel Comics Group stamp and a handwritten note from John Romita Jr. that reads, "One of my first, if not the first, piece for Marvel. — JRJR '14". The artwork was also autographed on the back in 2014 by the writer of the story and co-creator of Wolverine, Len Wein.

Included with the lot is a reference copy of *The Mighty World of Marvel #199*, the comic book in which this art was originally published. The artwork shows glue residue and smudges to the board and remains in fair condition. Dimensions: 44 cm x 28.5 cm (17 1/4" x 11 1/4")

£3,000-4,500



596. Arthur Kipps' (Daniel Radcliffe) Costume †Δ

THE WOMAN IN BLACK (2012)

Arthur Kipps' (Daniel Radcliffe) costume from the period horror *The Woman in Black*. Kipps wore his costume throughout the film, after being sent to the village of Crythin Gifford to manage the estate of the recently deceased Mrs Drablow (Alisa Khazanova).

The costume comprises a grey herringbone waistcoat, with matching trousers and a white collarless cotton shirt. The waistcoat displays brown buttons, with three small pockets and an adjustable back strap. The shirt shows light signs of wear from use, including marks around the collar and cuffs.

£400-600



597. Fisher Sisters' Dresses †Δ

THE WOMAN IN BLACK (2012)

The Fisher sisters' dresses from the period horror *The Woman in Black*. The Fisher sisters wore their dresses during the film's opening scene as they were mysteriously lured to their death by the sinister Woman in Black (Liz White).

The lot comprises two floral dresses, one pink and one blue, with a cream pinafore accompanying the blue dress. The pleated dresses feature long sleeves with a Peter Pan collar and are each secured at the back with hook-and-eye fastenings and a press stud. The pinafore displays frills on the shoulders and is fastened at the back with a single button. Both dresses remain in very good condition.

£200-300



598. Rocking Chair †Δ

THE WOMAN IN BLACK (2012) & THE WOMAN IN BLACK: ANGEL OF DEATH (2014)

A rocking chair from the period horror *The Woman in Black* and its sequel *The Woman in Black 2: Angel of Death*. A rocking chair was found in the nursery of Eel Marsh House, most notably when Arthur Kipps (Daniel Radcliffe) began to explore the mysterious house and witnessed a vision of *The Woman in Black* rocking in her chair.

The rocking chair is comprised of a dark-brown painted wooden frame and purple velour padded upholstery. The button-back chair features turned detailing on the frame and velour padding on the arms. Heavily distressed to appear old and worn during the production of *Angel of Death*, the upholstery has been covered in artificial mud and mould. The cushion has come loose from the front of the seat and there are chips to the painted frame.

Dimensions: 130 cm x 81 cm x 118 cm (51 ¼" x 32" x 42 ½")

£1,000-2,000



599. Cyclops' (James Marsden) Paint-Test Visor M

X-MEN (2000)

Cyclops' (James Marsden) paint-test visor from Bryan Singer's comic-book adaptation *X-Men*. Paint-test items are used by makeup artists to visualise characters, and thereby achieve the right production effect.

Cyclops' visor is made of cast-in resin mixed with aluminium powder to give it a fine metallic finish. Its design is nearly identical to the visors used during production. It is spray-painted metallic dark silver on the left and matte dark silver/grey on the right, with a central dividing line to indicate the visor's use for comparative purposes. The right earpiece features a handwritten sticker inside reading, "Fit Blk Auto Clear W Pearl", referring to the paint on the left half. The visor features minor chips, scratches and imperfections from use during production. A 20th Century Fox certificate of authenticity is included with the item.

Dimensions: 20 cm x 17 cm x 9 cm (8" x 6 ¾" x 3 ½")

£1,500-2,500



600. Wolverine's (Hugh Jackman) Dog Tag and Sideburns †Δ

X-MEN (2000)

Wolverine's (Hugh Jackman) sideburns and dog tag from Bryan Singer's comic-book adaptation *X-Men* (2000). Key to his back story, Wolverine's dog tag appeared in close-up during the cage-fight and motorhome scenes with Rogue (Anna Paquin). The character sported distinctive sideburns throughout the film, created using hairpieces over Hugh Jackman's facial hair to form a feral beard that matched his wolf-like hairstyle.

The rectangular metal dog tag hangs from slender, interlinked metal chains and has "Wolverine" and the digits "458 25 243" stamped on it. The sideburns are made from real hair and feature application glue residue. The dog tag exhibits production wear and scratches from use, while the sideburns show minor wear from use. The sideburns are accompanied by a 20th Century Fox certificate of authenticity.

Dimensions (dog tag on chain): 41.5 cm x 4.5 cm x 0.2 cm (16 ½" x 1 ¾" x ¼"); (sideburns in case): 16 cm x 13.3 cm x 1.8 cm (6" x 5 ¼" x ¾")

£2,000-3,000

601. Wolverine's (Hugh Jackman) Stunt Claws Ω**X-MEN 2 (2003)**

Wolverine's (Hugh Jackman) stunt claws from Bryan Singer's superhero sequel *X-Men 2*. The claws are made of urethane and mounted on machined metal grips. The grips are marked "L2" and "R2" to indicate the correct hand for each claw. The top edges of the claws rolls around the wearer's knuckles, giving the illusion that the blades protrude from Wolverine's skin. The claws are painted a faux-silver colour and are cast with grooves on the sides to simulate sharpened blades.

Accompanying the claws is a letter of authenticity from stunt coordinator Gary Jensen. The claws show minor wear due to production use, but remain in very fine condition. Dimensions (each): 27 cm x 10 cm x 4 cm (10 ½" x 3 ¾" x 1 ½")

£4,000-6,000**602. Young Logan's (Troye Sivan) Stunt Bone Claws** Ω**X-MEN ORIGINS: WOLVERINE (2009)**

Young Logan's (Troye Sivan) stunt bone claws from Gavin Hood's superhero movie *X-Men Origins: Wolverine*. The young Logan — born James Howlett — had bone claws early in the film.

These pieces are specifically made for the young actor's hands. The claws are made of urethane, extending from aluminium grips. Each claw is finished with brown-and-tan paint highlights to make it resemble a length of real bone. A small "L" and "R" are scratched onto the bottom palm grip of each respective set, and each one is labeled "soft". This lot shows minor signs of wear, but remains in very fine overall condition.

Dimensions: 25.5 cm x 6.5 cm x 4 cm (10" x 2 ½" x 1 ½")

£3,000-5,000**603. John Byrne Hand-Drawn Wolverine Artwork Commission** Ω**X-MEN (CIRCA LATE 1970S TO 1980)**

John Byrne hand-drawn fan-commissioned artwork featuring Wolverine from *X-Men*. Commissioned by a fan at a convention, this John Byrne illustration (from the late 1970s or 1980) shows Wolverine slashing down with his claws fully exposed. The pose is very similar to the cover of Wolverine's first solo story in *Uncanny X-Men #133*.

This original pencilled and inked artwork is drawn on illustration paper and shows John Byrne's signature next to Wolverine. Included with this lot is a reference copy of *Uncanny X-Men #133*. The cover to this issue features an image of Wolverine by John Byrne that is similar to the art offered in this lot. The artwork remains in very fine condition.

Dimensions: 27 cm x 35.5 (10 ½" x 14")

Please note this lot is sold without copyright, reproduction rights, licencing agreements or any other type of legal release.

£2,000-3,000**604. Xena's (Lucy Lawless) Balanced Chakram Weapon** M**XENA: WARRIOR PRINCESS (TV SERIES, 1995 - 2001)**

Xena's (Lucy Lawless) balanced Chakram weapon from the fantasy series *Xena: Warrior Princess*. Xena wielded her signature weapon in multiple episodes and passed the Chakram onto Gabrielle (Renée O'Connor) in the season six finale "Friend in Need". The balanced version was formed by merging the Chakram of Light with the Dark Chakram; the complete weapon resembling the Chinese Yin-Yang symbol.

Made of dense rubber, the outer edge of the throwing weapon is finished in faux silver to replicate the appearance of metal. Cast-in texture adorns the central wave design, which has been painted faux bronze and faux gold. The Chakram displays minor scratches on the edges, with marks and paint wear from use on production.

Dimensions: 25 cm x 25 cm x 1 cm (10" x 10" x ½")

£3,000-5,000

Buyer's Guide

Privacy Policy

By registering for this auction, you consent to us contacting you regarding your bidding activity and about important updates regarding the running of the auction. We will not pass your information on to any third parties. You can view our privacy policy at propstore.com/privacy-policy

Buyer's Guide

1. Introduction

This Buyer's Guide contains a brief overview of Prop Store's auction process and the terms under which Lots are made available for sale at auction. A more detailed statement of our Terms and Conditions of Sale follows after this Buyer's Guide. Please read the Buyer's Guide and the Terms and Conditions of Sale carefully. By registering to bid and participate in a Prop Store auction, you will be deemed to have agreed to be bound by them.

2. Definitions

2.1. When the following words are used in this Buyer's Guide, they mean:

Auction	A live sale by auction hosted by Prop Store
Bidder	Any person, properly registered and approved by Prop Store to participate in the Auction who makes or considers making a bid to buy a Lot at Auction
Buyer	The person or organisation making the highest bid or offer for a Lot accepted by the auctioneer, including a principal bidding as agent
Buyer's Premium	A commission of 23% (plus VAT if applicable) of the Hammer Price for a Lot, payable by the Buyer to Prop Store
Conditions of Sale	Prop Store's terms and conditions of sale at auction, from time to time as may be amended, a copy of which appears in the Buyer's Guide
Guarantee of Attribution	Prop Store's limited guarantee relating to the provenance of each Lot, given to the extent set out in Condition 10 of the Terms and Conditions of Sale
Hammer Price	The highest bid for a Lot accepted by the auctioneer at the Auction or the post-Auction sale price of that Lot
Lot	Each item or group of items consigned by the Seller to Prop Store to be made available for sale at an Auction, as detailed in the catalogue
Prop Store	Prop Store Limited (company number 08622002) of Great House Farm, Chenies, Rickmansworth, WD3 6EP
Purchase Price	The Hammer Price plus Buyer's Premium (plus VAT if applicable)
Reserve Price	Where applicable, the minimum price at which the Seller has authorised Prop Store to sell a Lot
Seller	The person or organisation offering the Lot for sale, including their agents or personal representatives

3. Before the Auction

3.1. Bidder Registration

- 3.1.1. Every person or organisation wishing to make a bid is required to register with Prop Store before participating at an Auction.
- 3.1.2. To register, the registration form (available in this Buyer's Guide or online at propstore.com) must be completed in full and Prop Store provided with valid Visa, MasterCard or American Express credit card details to be held on file; and
 - 3.1.2.1. at least one (1) form of ID is required which must include one (1) government-issued photo identification. If this does not state your current address, proof of address will also be required.
 - 3.1.2.2. An organisation must provide a certified copy or original certificate of incorporation, or, in the case of unregistered entities, other evidence satisfactory to Prop Store – contact Prop Store on +44 (0)1494 766485 for confirmation of what will be acceptable;
 - 3.1.2.3 A person registering as an agent to bid on behalf of a third party must bring the appropriate identification documents as set out above for themselves and for the third party on whose behalf they are authorised to make a bid and provide to Prop Store a signed authorisation from the third party confirming their authority to participate at the Auction on that third party's behalf.

3.2. Pre-Auction Viewing

- 3.2.1. Over 250 of the Lots can be previewed at the public exhibition held at ODEON BFI IMAX, 1 Charlie Chaplin Walk, Waterloo, London SE1 8XR from Thursday 6 September – Thursday 20 September, 10:00 am – 9:30 pm on weekdays and 11:00 am – 9:30 pm on weekends. Please enquire if the lot you are interested in is included in the exhibition.
- 3.2.2. During the Pre-Auction Viewing period, as set forth in the Auction catalogue, any Bidder may preview Lots not present in the public exhibition free of charge by appointment with Prop Store.

3.3. Delivery Costs

- 3.3.1. Without any liability, Prop Store can provide shipping estimates before the Auction; a Bidder requiring this information should email shipping@propstore.com including the Lot number and shipping address at least 3 working days before the start of the Auction.

3.4. Bidders outside the U.K.

- 3.4.1. If the Bidder is based outside the United Kingdom, the Bidder should ensure in advance of the Auction that the Lot can be exported from the U.K. and imported into the country of destination. No sale will be cancelled because the Lot may not be imported into the country of destination.
- 3.4.2. Prop Store's recommended third-party independent freight agent, Precision Cargo, can advise Bidders on relevant export licensing regulations and may submit export licence applications upon request. Neither Prop Store nor its freight agents can guarantee that any licences, permits or consents will be granted.

Buyer's Guide

4. At the Auction

- 4.1. Estimates
 - 4.1.1. Estimates represent Prop Store's guide to Bidders and do not give any indication or representation of actual values or likely bids. Estimates do not include any Buyer's Premium or VAT.
 - 4.1.2. Prop Store reserves the right to amend its estimates from time to time.
- 4.2. Reserve Price
 - 4.2.1. The Reserve Price is the minimum price the Seller will accept for a Lot. The Reserve Price will not be more than the lowest estimate given by Prop Store. Prop Store may disclose or keep confidential the Reserve Price at its entire discretion.
- 4.3. Bidding
 - 4.3.1. All bids are by individual Lot unless the auctioneer states to the contrary during the live Auction. Lots will usually be sold in their numbered sequence, unless the auctioneer announces otherwise.
 - 4.3.2. All bids must be made in English only.
 - 4.3.3. The auctioneer may accept bids from Bidders present in the saleroom, via telephone, online or written bids delivered to Prop Store before the Auction commences, either using the form in this Buyer's Guide or the online form at propstore.com.
 - 4.3.4. Telephone Bidders must provide to Prop Store a list of Lots on which they intend to bid at least 24 hours before the start of the Auction. Telephone bids will only be accepted on Lots with low-end estimate of at least £500 and telephone calls may be recorded by or on behalf of Prop Store.
 - 4.3.5. Written bids will be executed at the lowest possible price, taking into account the Reserve Price.
 - 4.3.6. Online bids shall be made in accordance with and subject to the terms of the online auction platform access provider.
 - 4.3.7. The auctioneer may also execute (non-identified) bids on behalf of the Seller up to the Reserve Price only. No bids may be made by the Seller in excess of the Reserve Price.
 - 4.3.8. Save as expressly stated in this Buyer's Guide, Prop Store accepts no liability for errors or omission in respect of bids made online, by telephone or in writing.
 - 4.3.9. The auctioneer may accept or decline bids at his entire discretion.

5. After the Auction

- 5.1. Successful bids
 - 5.1.1. Prop Store will notify successful Bidders and send (by email unless requested otherwise) a payment invoice setting out the Purchase Price and itemising the Hammer Price, Buyer's Premium, and if applicable Buyer's Expenses plus any applicable VAT within 7 calendar days of the end of the Auction.
- 5.2. Payment
 - 5.2.1. Payment is due within 7 calendar days from receipt of invoice and must be made by the Buyer. Payments from any other source will not be accepted and shall be returned by Prop Store.
 - 5.2.2. Payment must be in Pounds Sterling and may be made by electronic transfer, debit card, credit card (up to a maximum of £25,000) Banker's draft or cash (up to a maximum of £5,000). Please quote the Lot number, invoice number and Bidder registration number when making payment to ensure it can be processed as efficiently as possible.
 - 5.2.3. Credit card payments are only acceptable on the express understanding that the Lot is not returnable, refundable nor exchangeable and no charge card credit may be issued in the event of any such return. If payment is made by credit card, Buyer will not undertake any action or effort to stop payment, seek a refund, or attempt a charge back of such amounts – or any Credit Card Fee assessed thereon – by the issuer of the credit card.
 - 5.2.4. **[†]** These lots are sold under standard VAT rules. For buyers within the EEC, 20% VAT will be due on the hammer price; 20% VAT will also be due on the Buyer's premium. If EEC based buyer is a business outside of the U.K. who has provided their VAT number, no VAT will be due. When lots are exported outside the EEC (proof of export required or shipped by Prop Store or through Prop Store's authorised shipper), no VAT will be due on the hammer price; 20% VAT will be due on the Buyer's premium only; unless items are exported to a registered business outside the EEC, in which case no VAT is due.

[Ω] These lots have been temporarily imported from outside the EEC for sale at auction in London. For buyers within the EEC (private individuals or registered businesses), 5% VAT will be due on the hammer price; 20% VAT will also be due on the Buyer's premium. When lots are exported outside the EEC (proof of export required or shipped by Prop Store or through Prop Store's authorised shipper), no VAT will be due.

[M] These lots are sold under the margin scheme. For buyers within the EEC (private individuals or registered businesses), no VAT will be due on the hammer price; 20% VAT will be due on the Buyer's premium. When lots are exported outside the EEC (proof of export required or shipped by Prop Store or through Prop Store's authorised shipper), no VAT is due.

[US] These lots are currently located in Prop Store's Los Angeles facility and will ship directly to the buyer from the Los Angeles facility. For buyers within the EEC (private individuals or registered businesses), no VAT will be charged by Prop Store on the hammer price; 20% VAT will be due on the Buyer's premium. For buyers outside the EEC, no VAT will be charged by Prop Store.
- 5.3. Export and Import
 - 5.3.1. It is the Buyer's sole responsibility to arrange and obtain all necessary export/import licences, permits and any other necessary consents before the Lot is shipped.
 - 5.3.2. Prop Store's third-party independent recommended freight agent will be able to deal with enquiries from Bidders and Buyers on importing and/or exporting of Lots. Precision Cargo is Prop Store's freight agent of choice.
 - 5.3.3. With regards to lots exported outside the EEC, if your Lots are shipped by Prop Store or through Prop Store's authorised shipper, you will not be required to pay VAT when settling your invoice. If you are using any other shipper, or hand carrying your Lots outside the EEC, then VAT will be due on the invoice, which will be refunded once acceptable proof of export is provided by your shipper of choice.
 - 5.3.4. To prove export of your Lots, on Ω Lots, obtain HMRC form C88 through Prop Store's authorised shipper, which must be stamped by HMRC upon leaving the U.K.. On † or margin scheme Lots, obtain Notice 4 07 from Prop Store's authorised shipper, which must be stamped by HMRC upon leaving the U.K.. In all cases Lots must be exported within no more than 3 months of the sale date, and proof of export must be reported via the appropriate form.
- 5.4. Shipping and storage
 - 5.4.1. The Buyer is solely responsible for all shipping and delivery costs. Prop Store recommends Lots are custom-packed and recommends FedEx as its carrier of choice. For oversized Lots, Prop Store recommends Precision Cargo.
 - 5.4.2. In the event of delay in shipping or failure to collect a Lot (for a reason outside Prop Store's control) within 14 days of the due date for payment of Prop Store's invoice (or such other date for shipping or collection agreed by Prop Store) a storage fee of 3% of the Hammer Price per month shall be charged to the Buyer. If the Buyer has failed to pay the Purchase Price and the cost of shipping and handling, Prop Store, at its option may cancel the sale.

Terms & Conditions

Terms & Conditions

These Terms and Conditions of Sale ("Conditions") set out the legal relationship between the Bidder/Buyer and Prop Store and the Seller. By registering to bid and participate in a Prop Store Auction, you will be deemed to have read and agreed to be bound by these Conditions and the accompanying Buyer's Guide, as set forth in the catalogue for the Auction and online at propstore.com.

1. Interpretation

These Conditions shall include the terms set out in the Prop Store Live Auction Buyer's Guide, a copy of which has been made available to the Bidder. In the event of any conflict between these Conditions and the Buyer's Guide, these Conditions shall take precedence.

2. Definitions

- 2.1. See 2.1 of Buyer's Guide on page [410] of this catalogue

3. Prop Store as agent

- 3.1. Unless expressly agreed otherwise, Prop Store acts as agent for the Seller. The contract for the sale of the Lot is made between the Seller and the Buyer.

4. Catalogue descriptions and condition of Lots

- 4.1. All Lots are sold subject to their condition at the date of the Auction. The nature and age of the Lots means they are often unique and are likely to have wear and tear, damage and other imperfections and may have been totally or partially restored or repaired. By making a bid, the Bidder accepts the actual condition of the Lot and acknowledges that if a bid is successful, the Buyer will buy the Lot 'as is'.
- 4.2. Prop Store's staff are not professional restorers so descriptions of Lots, images and statements of condition in Prop Store's brochure or on its website are for illustrative purposes only. Poster lots in the auction may have undergone restoration; Prop Store staff will make reasonable efforts to identify any restoration and this will be disclosed within the lot description. Prop Store cannot guarantee that colours are properly shown. Save for Prop Store Terms of Guarantee of Attribution all Lots are sold 'as is'. Prop Store cannot and does not warrant the longevity of any restoration work carried out at any point in a lot's lifetime. Bidders are encouraged to inspect Lots and satisfy themselves as to condition before bidding, taking independent professional advice where required.
- 4.3. Condition reports are available for each lot upon request
- 4.4. Film posters in the sale include condition abbreviations: M = mint; EX = excellent; VG = very good; G = good; F = fair
- 4.5. Lots are sold only as collectibles and unless stated expressly to the contrary, Prop Store makes no representation or warranty that any Lot is fit for any other purpose.
- 4.6. Mannequins, display stands, scale measures and other display equipment are not included with the Lots unless expressly stated in the Lot description in the catalogue.
- 4.7. Estimates are simply a guide and should not be relied upon as to advice on value or the ultimate Purchase Price, which could be significantly higher.

5. Before the Auction

- 5.1. Every Bidder must register with Prop Store (including providing evidence of identity) in accordance with the Buyer's Guide. Personal information shall be used only in accordance with Condition 8 below.
- 5.2. From time to time, Prop Store may offer a Lot which it owns in whole or in part or in which it has a financial interest and any such Lot will be identified in the catalogue with the symbol Δ next to its Lot number.
- 5.3. Bidders are aware that, due to the one-of-a-kind nature of the materials, Prop Store only guarantees the provenance of Lots to the extent set out in the Terms of Guarantee of Attribution, and Prop Store will not accept returns of any material and will not issue refunds, credits or exchanges except as provided for in the Guarantee of Attribution.
- 5.4. As a courtesy to Buyers, Prop Store offers interest free payment plans on all auction Lots (see Condition 7.3 of the Conditions of Sale).

6. At the Auction

- 6.1. Prop Store reserves the right to refuse admission and/or participation at the Auction and to reject any bid. Bids may not be accepted from unregistered bidders and all Bidders must be 18 or over.
- 6.2. All bids must be made in GBP Sterling. The auctioneer has the right to exercise reasonable discretion in refusing any bid, advancing the bidding in such a manner as he may decide, withdrawing or dividing any Lot, combining any two or more Lots and, in the case of error or dispute, and whether during or after the sale, determining the successful Bidder, continuing the bidding, cancelling the sale or reoffering and reselling the Lot in dispute. If any dispute arises after the sale, then, in the absence of any evidence to the contrary the sale record maintained by the auctioneer will be conclusive.
- 6.3. Unless otherwise indicated, all Lots are offered subject to a Reserve Price. The Reserve Price will not exceed the low estimate printed in the catalogue. The Reserve Price will not be more than the lowest estimate given by Prop Store. Prop Store may disclose or keep confidential the Reserve Price at its entire discretion.
- 6.4. The auctioneer may open the bidding on any Lot below the Reserve Price by placing a bid on behalf of the Seller. The auctioneer may continue to bid on behalf of the Seller up to the amount of the Reserve Price, either by placing consecutive bids or by placing bids in response to other Bidders.
- 6.5. When making a bid, every Bidder acknowledges that such bid is a binding offer to buy the Lot at that price (plus the Buyer's Premium, Buyer's Expenses (if applicable), all applicable taxes and any and all shipping charges, storage and other costs). A successful Bidder will be deemed to be the Buyer unless it has been explicitly agreed in writing with Prop Store before the start of the Auction that the Bidder is acting as agent on behalf of an identified third party acceptable to Prop Store (and registered with Prop Store), and only then will Prop Store regard that third party as the Buyer. In such circumstances, the Bidder acting as agent confirms that he is authorised to bind the third party and that the Buyer has been made aware of and accepts these Conditions.
- 6.6. Prop Store will use reasonable efforts to execute written bids delivered before the Auction for Bidders unable to attend the auction in person, by an agent or by telephone or online. All such written bids must be made on Prop Store's Absentee Bids Form (in the catalogue).
- 6.7. If Prop Store receives written bids on a particular Lot for identical amounts, and at the auction these are the highest bids on the Lot, it will be sold to the person whose written bid was received and accepted first.
- 6.8. Online bidding at Prop Store Auctions is made available via third party service providers and use of their services and all online bidding is subject to their respective terms of use. Successful online bids will be subject to payment of Buyer's Expenses.
- 6.9. The Auction will be tracked on a video or digital screen, which may display, among other things, a photograph of the Lot offered for sale and the then current bid. Bidders understand and agree that errors may occur in its operation and, except as expressly stated in the Buyer's Guide or these Conditions, Prop Store shall have no liability arising out of or related to any errors or omission in respect thereto.

Terms & Conditions

6.10. By participating in and/or attending the Auction and signing the registration form, each person consents to be filmed and/or photographed and agrees and authorises Prop Store to use and publish such film and/or photographs, name and likeness for use in (1) providing online access to the Auction, (2) recording the results of the Auction, (3) print, digital, online and all other media for marketing purposes (including without limitation, on Prop Store's website, YouTube and other online platforms) and (4) in any other Prop Store publications of whatever nature. The participant releases Prop Store and holds it harmless from any reasonable expectation of confidentiality or privacy associated with such images and releases Prop Store and any third parties involved in the making, creation or publication of the images or any marketing or other materials from all and any liability for claims made in respect of such publication. Publication of the images in whatever format confers no right of ownership on the individual or right to royalties or payment. A designated area will be set aside if you do not wish to be filmed. If you wish to withdraw consent, email support@propstore.com.

6.11. Subject to the auctioneer's reasonable discretion, the Bidder placing the highest bid accepted by the auctioneer will be the Buyer and the striking of his hammer marks the acceptance of the highest bid and the conclusion of a contract for sale between the Seller and the Buyer. Risk and responsibility for the Lot (including frames or glass where relevant) passes to the Buyer on the date seven calendar days from the date of the sale or on collection by the Buyer if earlier and the Buyer should arrange insurance cover for the Lot if required.

7. After the Auction

7.1. Prop Store will notify successful Bidders and send (by email unless requested otherwise) a payment invoice setting out the Purchase Price and itemising the Hammer Price and Buyer's Premium plus any applicable VAT within 7 calendar days of the end of the Auction.

7.2. Unless a payment plan (as set out in condition 7.3 below) has been agreed by Prop Store, payment is due within 7 calendar days from receipt of invoice and must be made by the Buyer. Payments from any other source will not be accepted and shall be returned by Prop Store.

7.3. Payment plans will be available in 1, 2, or 3 month increments. Bidders wishing to utilise the payment plan service, if approved by Prop Store, will be responsible for paying a 20% deposit on their Lots within 7 calendar days of receiving their invoice. The balance will then be split over 1, 2 or 3 months per the Buyer's selection. If the 1 month option is selected, the remaining balance on the Lot will be due 30 days after the deposit date. If the 2 month option is selected, half of the remaining balance will be due 30 days after the deposit date and the remaining half 30 days after that, and so on.

7.4. Prop Store offers no grace period on payment plan deadline. If the Buyer does not adhere to payment deadline as agreed under the terms of the payment plan, the Buyer will have defaulted. In the event of default all funds already paid to Prop Store will be forfeited by the Buyer, and title of the Lot will not transfer to Buyer. Prop Store and the Seller shall also be entitled to all remedies for non-payment as described below and at law.

7.5. Title in the Lot will pass to Buyer and the Lot will be made available for collection by the Buyer only when Prop Store is completely satisfied that all monies owing have been paid in full.

7.6. Payment must be in Pounds Sterling and may be made by electronic transfer, debit card, credit card (up to a maximum of £25,000) bankers draft or cash (up to a maximum of £5,000). Please quote the Lot number, invoice number and Bidder registration number when making payment to ensure it can be processed as efficiently as possible.

7.7. Credit card payments are only acceptable on the express understanding that the Lot is not returnable, refundable nor exchangeable and no charge card credit or refund may be issued in the event of any such return. If payment is made by credit card, Buyer will not undertake any action or effort to stop payment, seek a refund, or attempt a charge back of such amounts – or any Credit Card Fee assessed thereon – by the issuer of the credit card.

7.8. [†] These lots are sold under standard VAT rules. For buyers within the EEC, 20% VAT will be due on the hammer price; 20% VAT will also be due on the Buyer's premium. If EEC based buyer is a business outside of the U.K. who has provided their VAT number, no VAT will be due. When lots are exported outside the EEC (proof of export required or shipped by Prop Store or through Prop Store's authorised shipper), no VAT will be due on the hammer price; 20% VAT will be due on the Buyer's premium only; unless items are exported to a registered business outside the EEC, in which case no VAT is due.

[Ω] These lots have been temporarily imported from outside the EEC for sale at auction in London. For buyers within the EEC (private individuals or registered businesses), 5% VAT will be due on the hammer price; 20% VAT will also be due on the Buyer's premium. When lots are exported outside the EEC (proof of export required or shipped by Prop Store or through Prop Store's authorised shipper), no VAT will be due.

[M] These lots are sold under the margin scheme. For buyers within the EEC (private individuals or registered businesses), no VAT will be due on the hammer price; 20% VAT will be due on the Buyer's premium. When lots are exported outside the EEC (proof of export required or shipped by Prop Store or through Prop Store's authorised shipper), no VAT is due.

[US] These lots are currently located in Prop Store's Los Angeles facility and will ship directly to the buyer from the Los Angeles facility. For buyers within the EEC (private individuals or registered businesses), no VAT will be charged by Prop Store on the hammer price; 20% VAT will be due on the Buyer's premium. For buyers outside the EEC, no VAT will be charged by Prop Store.

7.9. The Buyer will not acquire title to the Lot until all amounts due to the Seller and Prop Store from the Buyer have been received by Prop Store in cleared funds even in circumstances where Prop Store has released the Lot to the Buyer.

7.10. By registering for this auction the Buyer authorises Prop Store to charge the credit card provided at registration for all Lots purchased at the auction, and any future auction a Bidder may participate in, if not paid in full within 7 calendar days after the auction closes.

7.11. If the Buyer does not make any payment due to Prop Store by the due date for payment, Prop Store may charge interest on the overdue amount at the rate of 5% a year above the base lending rate of LloydsTSB Bank plc from time to time. This interest shall accrue on a daily basis from the due date until the date of actual payment of the overdue amount, whether before or after judgment. The Buyer must pay Prop Store interest together with any overdue amount.

7.12. In addition to its rights in condition 7.11 and at law, in the event of default by the Buyer, Prop Store may take one or more of the following actions:

7.12.1. hold the Buyer liable for the total amount due and commence legal proceedings for its recovery together with interest, legal fees and costs to the fullest extent permitted under applicable law;

7.12.2. cancel the sale;

7.12.3. resell the Lot publicly or privately on such terms as Prop Store shall think fit;

7.12.4. pay the Seller an amount up to the net proceeds payable in respect of the Hammer Price;

7.12.5. set off against any amounts which Prop Store may owe to the Buyer in any other transactions, some or all of the outstanding amount remaining unpaid by the Buyer;

7.12.6. apply any amount paid to discharge any amount owed in respect of any particular transaction, whether or not the Buyer so directs;

7.12.7. reject at any future auction any bids made by or on behalf of the Buyer or to require a deposit from the Buyer before accepting any further bids;

7.12.8. exercise all the rights and remedies of a person holding security over any Lot in Prop Store's possession owned by the Buyer, whether by way of pledge, security interest or in any other way, to the fullest extent permitted by the law of the place where such Lot is located. The Buyer will be deemed to have granted such security to Prop Store and it may retain such Lot as collateral security for such Buyer's obligations;

7.12.9. take such other action as Prop Store deems necessary or appropriate. If Prop Store resells the Lot under condition 7.12.3 above, the Buyer shall be liable for payment of any deficiency between the total amount originally due to Prop Store and the amount received upon resale as well as all reasonable costs, expenses, damages, legal fees and commissions and premiums of whatever kind associated with both sales or otherwise arising from the default. If Prop Store pays any amount to the Seller under condition;

Terms & Conditions

- 7.12.10 above, the Buyer acknowledges that Prop Store shall have all of the rights of the Seller, however arising, to pursue the Buyer for such amount.
- 7.13. Prop Store shall be entitled to retain Lots sold until all amounts due have been received in full in good cleared funds or until the Buyer has performed any other outstanding obligations as Prop Store shall reasonably require. Subject to this, the Buyer shall collect, or have shipped or collected for shipment, purchased Lots within 7 calendar days from the date of the sale unless otherwise agreed between Prop Store and the Buyer. Lots can be collected in person by appointment only.
- 7.14. Each Lot will require a custom packing service and by bidding on a Lot a Bidder agrees to pay all relevant shipping costs. Prop Store's carrier of choice is FedEx, although some Lots will require special freight service. Potential shipping estimates can be obtained by emailing shipping@propstore.com detailing the Lot number of interest and the shipping address prior to the auction.
- 7.15. Prop Store recommends working with its preferred third-party independent freight agent Precision Cargo on any questions regarding importing and exporting Lots.
- 7.16. Although Prop Store shall use reasonable efforts to take care when selecting third parties for these purposes, the Buyer will contract directly with such third party and Prop Store accepts no liability or responsibility for the acts or omissions of any such third parties. Similarly, where Prop Store suggests other handlers, packers or carriers, its suggestions are made on the basis of its general experience of such parties in the past and Prop Store is not responsible to any person to whom it has made a recommendation for the acts or omissions of the third party concerned.
- 7.17. It is the Buyer's sole obligation and responsibility to be aware of, to comply with, and to pay for all relevant import duties, taxes, VAT, customs and other fees charged in the Buyer's local jurisdiction. Prop Store will ship all packages with the full value of the Lot declared. Buyer understands and agrees that Prop Store shall have no obligation or responsibility for any import duties, taxes, VAT, customs, shipping or other charges for the Lots shipped. Failure by the Buyer to pay all necessary amounts may result in the relevant authorities returning the Lot to Prop Store and in those circumstances the Buyer will be charged and will pay storage cost and Prop Store's additional reasonable costs and expenses.
- 7.18. It is the Buyer's responsibility to ensure that any Lot purchased from Prop Store enters the shipping location lawfully, that all duties and taxes have been paid and that all required export procedures, regulations, and laws were properly complied with. Buyer understands and agrees that Prop Store shall have no obligation or responsibility for complying with any export procedures, regulations, or laws applicable to the Lot.
- 7.19. Unless otherwise agreed by Prop Store in writing, the fact that the Buyer wishes to apply for an export licence does not affect or postpone the Buyer's obligation to make payment in accordance with Prop Store's payment terms nor Prop Store's right to charge interest or storage charges on late payment. If the Buyer requests Prop Store to apply for an export licence on his or her behalf, Prop Store shall be entitled to make a charge and be paid for this service. Prop Store shall not be obliged to rescind or cancel a sale nor to refund any monies paid by the Buyer to Prop Store as a result of or related to the Buyer's failure or inability to obtain an export licence.
- 7.20. Where Lots are not collected within 14 calendar days from the due date of payment, whether or not payment has been made, a storage fee of 3% of the Hammer Price per month shall be charged to the Buyer. If the Buyer has failed to pay the Purchase Price and the cost of shipping and handling, Prop Store, at its option may cancel the sale.

8. Use of information

- 8.1. Prop Store will hold all personal information provided by the Bidder at registration and the Bidder agrees and consents to such information being used by Prop Store to:
- 8.1.1. make available each Lot for shipping to the Buyer;
 - 8.1.2. process the Buyer's payment;
 - 8.1.3. contact credit reference agencies and keep records of any searches carried out on Prop Store's behalf;
 - 8.1.4. where explicit consent has been given, inform the Bidder about upcoming news, offers, competitions, auctions (please contact Prop Store by email at support@propstore.com or by phone +44 (0)1494 766485 if you wish to stop receiving these);
 - 8.1.5. inform the Bidder about important auction updates;

9. Liability

- 9.1. If Prop Store fails to comply with these Conditions it is responsible for loss or damage a Buyer suffers that is a foreseeable result of Prop Store's breach or its negligence. Prop Store is not responsible for any loss or damage that is not foreseeable. Loss or damage is foreseeable if an obvious consequence of Prop Store's breach or if contemplated by the Buyer and Prop Store at the time the hammer falls on the Lot at the Auction.
- 9.2. Subject to condition 9.3, Prop Store's liability shall be limited to the amount actually paid for the Lot by the Buyer. Save to the extent required by law, in no event shall Prop Store be liable for incidental or consequential damages of any kind.
- 9.3. Prop Store does not exclude or limit its liability for:
- 9.3.1. death or personal liability caused by its negligence or the negligence of its employees, agents or subcontractors;
 - 9.3.2. fraud or fraudulent misrepresentation; and
 - 9.3.3. breach of the terms implied by sections 12, 13, 14 and 15 of the Sale of Goods Act 1979 (title, description, quality and fitness for purpose) save to the fullest extent permissible at law.

10. Terms of Guarantee of Attribution

- 10.1. Prop Store warrants the attribution of each Lot as stated in the title block (film title and item title) of that Lot in the Auction catalogue, subject to any revisions (which may be given in writing or online before or during the Auction at which the Lot is purchased by the Buyer); this is Prop Store's Guarantee of Attribution. Buyers should be aware that multiple examples of props and costumes are frequently used during production and it is often impossible to determine whether a specific piece has been used on-camera. Any specific on-camera usage known to Prop Store will be noted within the description, but no warranties are given by Prop Store on that description.
- 10.2. If a Buyer demonstrates, to Prop Store's reasonable satisfaction, that the Guarantee of Attribution is materially incorrect, the sale will be rescinded if the Lot is returned to Prop Store in the same condition in which it was at the time of sale. In order to satisfy Prop Store that the Guarantee of Attribution is materially incorrect, Prop Store reserves the right to require the Buyer to obtain, at the Buyer's expense, the opinion of two experts in the field, mutually acceptable to Prop Store and the Buyer.
- 10.3. In the event a sale is rescinded in accordance with condition 10.2, Prop Store shall repay to the Buyer the Purchase Price. Repayment of the Purchase Price shall be the Buyer's sole remedy for an incorrect Guarantee of Attribution, to the exclusion of all other remedies to the extent permissible at law. It is specifically understood that this will be considered the Buyer's sole remedy under this clause 10.
- 10.4. The Buyer expressly agrees that Prop Store shall not be liable in whole or in part, for, and the Buyer shall not be entitled to recover, any special, indirect, incidental or consequential damages including loss of profits or value of investment or opportunity cost.
- 10.5. Bidders are aware that description revisions may occur on some Lots, and should enquire before the Auction whether any description revisions have occurred on a given Lot and/or examine a lot before bidding on it. Prop Store will make all reasonable efforts to make description revisions readily available during the Auction.
- 10.6. Except as expressly provided in these Conditions Prop Store shall have no liability to the Buyer in respect of a Lot and all and any implied warranties and conditions are excluded to the fullest extent permitted by law.

Terms & Conditions

11. Intellectual property rights

- 11.1. The copyright in all images, illustrations and written material produced by or for Prop Store relating to a Lot (including the contents of the Auction catalogue), is and shall remain at all times the property of Prop Store and shall not be used by the Buyer, nor by anyone else, without Prop Store's written consent. Prop Store and the Seller make no representation or warranty that the Buyer of a Lot will acquire any copyright or other reproduction rights in it.
- 11.2. In the catalogue descriptions, Prop Store takes steps to identify and provide provenance for Lots offered at auction. In many cases, the Lots offered were used in or in conjunction with motion pictures or other programmes and information is furnished in order to fully identify and describe the Lot offered at Auction, including photographs and illustrations. Prop Store in no way claims any connection to or relationship with the producers of the motion picture or other programme. In all cases, the use of the titles or other elements of a motion picture or other programme is for informational purposes only.

12. Events outside our control

Prop Store will not be liable or responsible for any failure to perform, or delay in performance of, any of its obligations under these Conditions that is caused by an event outside its control, that being any act or event beyond Prop Store's reasonable control, including without limitation strikes, lock-outs or other industrial action by third parties, civil commotion, riot, invasion, terrorist attack or threat of terrorist attack, war (whether declared or not) or threat or preparation for war, fire, explosion, storm, flood, earthquake, subsidence, epidemic or other natural disaster, or failure of public or private telecommunications networks. Prop Store's obligations shall be suspended and time for performance extended until such time as the event outside its control is over, following which a new collection or shipping date can be agreed.

13. Other important terms

- 13.1. If any part of these Conditions is found by any court to be invalid, illegal or unenforceable, that part shall be discounted and the rest of the Conditions shall continue to be valid to the fullest extent permitted by law.
- 13.2. The contract is between the Seller, Buyer and Prop Store and no other person shall have any rights to enforce any of its terms.
- 13.3. If Prop Store fails to insist on performance of any of a Buyer's obligations under these Conditions, or if it delays in doing so, that will not mean that Prop Store has waived its rights against the Buyer and does not mean the Buyer no longer has to comply with those obligations.
- 13.4. These Conditions are governed by English law, without regard to its choice of law provisions. The Parties agree that any dispute or claim (including non-contractual disputes or claims) arising out of or in connection with this agreement or its subject matter or formation may be brought in any court of competent jurisdiction located in England or Wales or, alternatively, in any court of competent jurisdiction where Prop Store or the Bidder/Buyer resides, at the option of the Party bringing the claim, only. The Parties expressly agree to the jurisdiction of such courts and agree to submit to the jurisdiction of such courts. The prevailing party shall be entitled to an award of all attorneys' fees, costs and expenses incurred by it/him/her in connection with the dispute. "Attorneys' fees and expenses" includes, without limitation, paralegals' fees and expenses, attorneys', consultants' fees and expenses, expert witness' fees and expenses, and all other expenses incurred by the prevailing party or its attorneys in the course of their representation of the prevailing party in anticipation of and/or during the course of the litigation, whether or not otherwise recoverable as "attorneys' fees" or as "costs" under applicable law; and the same may be sought and awarded in accordance with applicable procedure as pertaining to an award of contractual attorneys' fees.
- 13.5. By registering for this auction, the supplied card will automatically have a sum of £0.01 held and subsequently returned within 30 working days to verify the validity of the card.
- 13.6. The buyer is solely responsible for ascertaining that each lot sold with copyright is otherwise cleared for publication including but not limited to satisfying any publicity right that persons appearing in an image may have under any statute or common law. Neither the consignor nor Prop Store Ltd makes any representation or warranty as to any matters that need to be cleared prior to publication. No representation or warranty is made regarding copyright outside of the United Kingdom. All publication issues should be referred to the buyer's own professional advisors. All representations or warranties as to copyright or rights to publish are solely made by the consignor and not Prop Store Ltd; the buyer agrees that Prop Store Ltd. will not be liable to Buyer in any respect for alleged breach of any such representation or warranty.

VAT Quick Reference Guide

VAT Status	Buyer Location / Business or Individual	VAT on Hammer Price	VAT on Buyer's Premium
Standard Rules (†)	EEC / Individual	20	20
	EEC Non-UK / Business	0	0
	Non-EEC / Individual	0	20
	Non-EEC / Business	0	0
Temporary Import (Ω)	EEC / Individual	5	20
	EEC Non-UK / Business	5	20
	Non-EEC / Individual	0	0
	Non-EEC / Business	0	0
Margin Scheme (M)	EEC	0	20
	Non-EEC	0	0
Items in Los Angeles (US)	EEC	0	20
	Non-EEC	0	0



© 2018 Warner Bros. Ent. All Rights Reserved. Wizarding World™ Publishing Rights © J.K. Rowling. Wizarding World™ TM & © Warner Bros. Entertainment Inc. Wizarding World™ Characters, Names and Related Indicia are TM and © Warner Bros. Entertainment Inc.

FANTASTIC BEASTS: THE CRIMES OF GRINDELWALD AT BFI IMAX

In cinemas 16th November 2018
London's biggest film experience

BFI IMAX  Waterloo

Book Now | www.ODEON.co.uk/bfimax | 0330 333 7878*

*Calls cost 10p per minute plus network extras

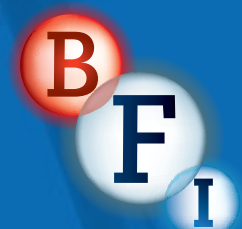

Proudly presented by ODEON

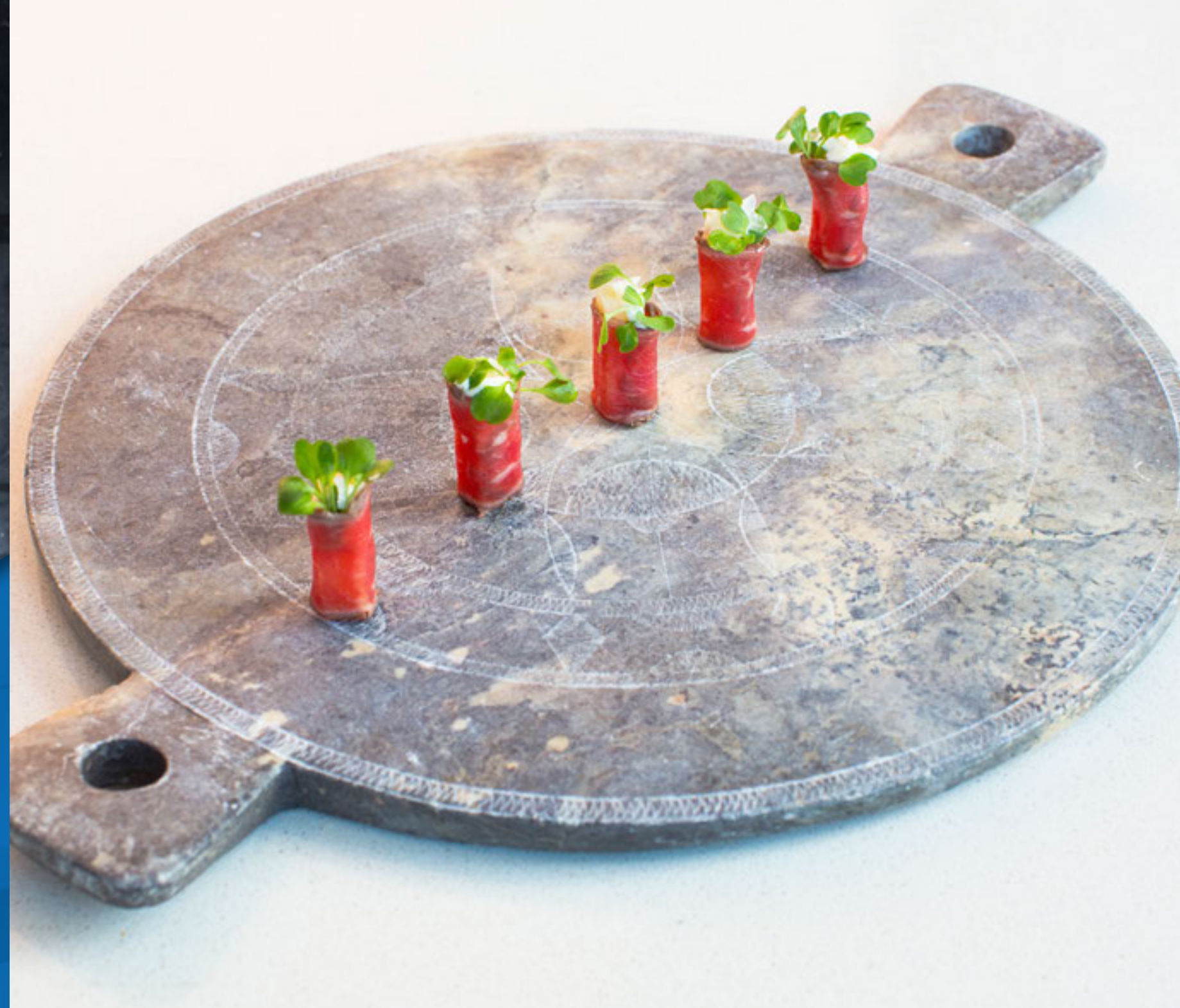

THE WHITE LABEL
BESPOKE FOOD & EVENT DESIGN

CONCEPTUAL EXPERIENCES - WEDDINGS - PRIVATE EVENTS - CORPORATE ENTERTAINMENT - INTERNATIONAL

For more information, call us on: +44 (0) 207 846 0168
or email: emma@thewhite-label.com

www.thewhite-label.com

 @whitelabel2018  @the_white_label_events  @TheWhiteLabelGB

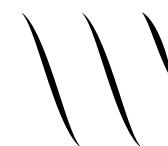



about presentation specialise in the design and manufacture of bespoke museum quality display cases for National Museums, private collectors, historic houses, visitor centres and events for hire or purchase.

Materials used conform to museum standards . Our portfolio offers a range of shapes, sizes and levels of security right up to Anti-Bandit specification. We also provide a full delivery and installation service anywhere in the UK, supported by a range of plinths, shelving and display mounts. Our Controllux LED conservation lighting range can bring the whole display to life.

01425 652373

Info@aboutpresentation.com
www.aboutpresentation.com



about presentation combines reliability and security with innovation and style, delivering quality display cases to showcase the worlds treasures.



Forever Hope Foundation



@forever_hope_fd



forever_hope_foundation



foreverhopefoundation

Raising funds and awareness for charities, both in the UK and internationally, to help them continue their vital work and restore hope to individuals and communities

www.foreverhope.org

SAS

Est. 1991

specialauctionservices.com



Not only do the 'bad guys' want diamonds and the world's finest antiques! So do SAS, we are happy to help with all your valuation and auction needs.... Call or email one of our auctioneers Thomas or Neil today
01635 580595

DIAMONDS ARE FOREVER
valuations@specialauctionservices.com

Precision

cargo services limited

OFFICIAL PARTNER

- Airfreight – Door-to-Door & Airport-to-Airport worldwide
- International Express Courier
- Ocean Freight Services
- European Road Freight

- Aircraft Charters
- Import & Export Customs Procedures
- ATA Carnet Advice & Completion
- Domestic Overnight Services
- Dangerous Goods Advice, Packing &

- Shipping Including Explosives
- BBC & ITV Approved Contractor
- Home Office Approved Section 5 & 1 for the Movement of Weaponry & Ammunition
- Storage & Packing

Pinewood Office: 01753 650551 | **Shepperton Office:** 01932 593377 | **Cardiff Office:** 02921 304102
Bristol Office: 0117 352 5022 | **Felixstowe Office:** 01394 613 113 & **LAX Office:** 310 410 0100

www.precisioncargo.co.uk bookings@precisioncargo.co.uk

Prop Store Live Auction Bidder Registration Form

Sale Name: Entertainment Memorabilia Live Auction

Sale Date: 20th September 2018



BIDDER INFORMATION

(If bidding as agent, complete one form as the third-party bidder and a second form as the agent. Both sets of contact information are required.)

Paddle Number (Prop Store Use Only):	Home Phone:
Name:	Cell Phone:
Business Name (if applicable):	Business Phone:
Mailing Address (include country):	Fax:
	Email:
	Credit Card Type (Visa, MC or AmEx):
Shipping Address (include country):	Credit Card Number:
	Credit Card Expiration Date:
Company Registration No. (if applicable):	Registering as (select one): Private Client <input type="checkbox"/> Trade Client <input type="checkbox"/>
	VAT Number if VAT registered in EU:

BIDDER NOTICES - PLEASE READ

1. If you wish to make a bid at a Prop Store Live Auction, you must pre-register with Prop Store on this form.
2. If registering as an individual, you must provide Prop Store with at least one (1) form of ID which must include one (1) government issued photo identification. If this does not state your current address, proof of address will also be required.
3. If registering as an organisation, you must provide a certified copy or original certificate of incorporation, or, in the case of unregistered entities, other evidence satisfactory to Prop Store - contact Prop Store at +44 (0) 1494 766 485 for confirmation or what will be acceptable.
4. If you are registering as an agent to bid on behalf of another party, you must produce the relevant ID documents at paragraphs 2 and 3 above for yourself and the person or organisation on whose behalf you are acting. In addition, you must provide to Prop Store a written and signed authority from the third party confirming your authority to bid on their behalf.
5. BY COMPLETING AND SUBMITTING THIS BIDDER REGISTRATION FORM, YOU ACKNOWLEDGE YOU HAVE READ, UNDERSTAND AND AGREE TO BE BOUND BY PROP STORE'S LIVE AUCTION CONDITIONS OF SALE (COPIES AVAILABLE IN THE AUCTION BUYER'S GUIDE, ON PROP STORE'S WEBSITE propstore.com OR ON REQUEST FROM PROP STORE) AND PRIVACY POLICY (AVAILABLE ON PROP STORE'S WEBSITE propstore.com)
6. In particular, please make yourself aware of Prop Store's payment terms, with all sums due within 7 working days from receipt of Prop Store's invoice. PROP STORE WILL ONLY ACCEPT PAYMENT FROM THE BUYER.
7. Save in circumstances required by law, Prop Store accepts no liability for errors or omissions in relation to bids.

Telephone Bidders: Telephone bidders must complete this form to provide Prop Store a list of Lots on which they intend to bid at least 24 hours before the start of the auction.

Absentee Bidders: Written bids will be executed at the lowest possible price, taking into account the Reserve Price. Absentee Bidders must complete this form to provide Prop Store with written bids at least 24 hours before the start of the Auction

Select One: Floor Bidder Telephone Bidder Absentee Bidder

I, the undersigned, have read and agreed to the terms and conditions of the sale.

(Signature)

(Date)

Please check here if you do not want us to disclose your personal data to ODEON so that they can provide you with information and special offers relating to their goods or services

Prop Store — London Office

Stephen Lane, CEO

Lizzie Lane, Director — lizzie@propstore.com

Sam Clegg, Director Of Operations — samc@propstore.com

Tim Lawes, General Manager — tim@propstore.com

Siân Taylor, Project Manager — sian@propstore.com

Priya Mudgil, Senior Administrator — priya@propstore.com

Sarah Sorkin, Photography Manager — sarah@propstore.com

Miranda McCabe, Marketing Manager — miranda@propstore.com

Graham Terry, Warehouse Manager — graham@propstore.com

Paul Wallis, Facilities Manager — paul@propstore.com

Luke Cozens, Shipping Manager — luke@propstore.com

Viki Merry, Project Leader — viki@propstore.com

Claire Freed, Listings Manager — claire@propstore.com

Cara Kimber, Inventory Manager — cara@propstore.com

Matt Storey, Poster Inventory Specialist — matts@propstore.com

James Chapman, Photography — james@propstore.com

Katie Males, Researcher & Copy Writer — katie@propstore.com

Chris Aikman, Researcher & Copy Writer — chrisa@propstore.com

George Dupree, Photography Assistant — george@propstore.com

Robert Aikman, Photography Junior — robert@propstore.com

Evelyn Ivanova, Graphics Assistant — evelyn@propstore.com

Ross Shaw, Graphics Assistant — ross@propstore.com

Jasmin Pearson, Inventory Assistant — jasmin@propstore.com

Sam Dietz, Inventory Assistant — inventoryuk@propstore.com

Telephone— +44 (0) 01494 766485

Prop Store — Los Angeles Office

Brandon Alinger, Global COO & President, North America — brandon@propstore.com

Chuck Costas, VP, Business Development and Operations — chuck@propstore.com

Greg Giroux, Director of IT & Product Manager — greg@propstore.com

Don Barnett, Director of Operations — donald@propstore.com

Dan Hill, General Manager — danhill@propstore.com

Brian Cordoba, Project Manager & Copywriter — brian@propstore.com

Justin Miller, Photography Manager — justin@propstore.com

Marcelles Murdock, Photography Manager — marcelles@propstore.com

Airi Minami, Graphics Manager — airi@propstore.com

Matt Truex, Project Manager — matt@propstore.com

Ryan Albertson, Intake Manager — ryan@propstore.com

Paul Gonzalez, Shipping Manager - paulg@propstore.com

Tami Garcia, Bookkeeper & Administration — tami@propstore.com

Charles Warr, Senior Graphics Associate — charley@propstore.com

Sarah Cierlak, Graphics Associate — sarahc@propstore.com

Freddy Ocataviano, Photography Associate — freddy@propstore.com

Christian Allison, Intake Associate — inventoryla@propstore.com

Andréa Hardy, Intake Associate — inventoryla@propstore.com

Natalie Rocha, Sales & Copywriting Associate — natalie@propstore.com

Adam Woodring, Shipping Associate - shipping@propstore.com

Jaret Blankenship, Warehouse Administrator — inventoryla@propstore.com

Devin Lofti, Photography Assistant — devin@propstore.com

Shay Delgado, Intake Assistant

Michael Schmidt, Intake Assistant

Ronald Stillwell, Intake Assistant

Kirsten Rast, Intake Assistant

Telephone — +1 818-727-7829

Catalogue Creative Team

Designers:

Airi Minami, Charles Warr, Greg Giroux, Sarah Cierlak

Photographers:

Sarah Sorkin, James Chapman, Justin Miller, Marcelles Murdock

Copywriters & Editors:

Brian Cordoba, Viki Merry, Siân Taylor, Cara Kimber, Alex Rodgers, Natalie Rocha, Katie Males, Chris Aikman, Claire Freed, Shelley Moench-Kelly, Brandon Alinger, Stephen Lane, Tim Lawes, Dan Jolin, Caleb Stenzinger

BACK COVER IMAGE

Lot #545 Light-Up T-800 Terminator Endoskeleton
TERMINATOR 2: JUDGEMENT DAY (1991)

Printed & bound by Eclipse Print Solutions www.eclipseprintsolutions.com

COPPER COIL EFFECT

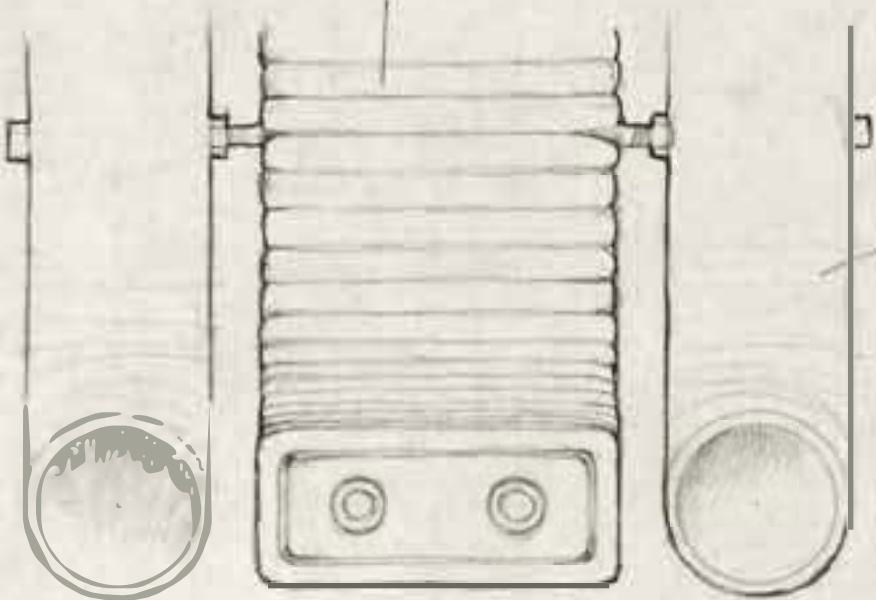

STAINLESS STEEL PIPE-GUARDS

ACTUAL SIZE

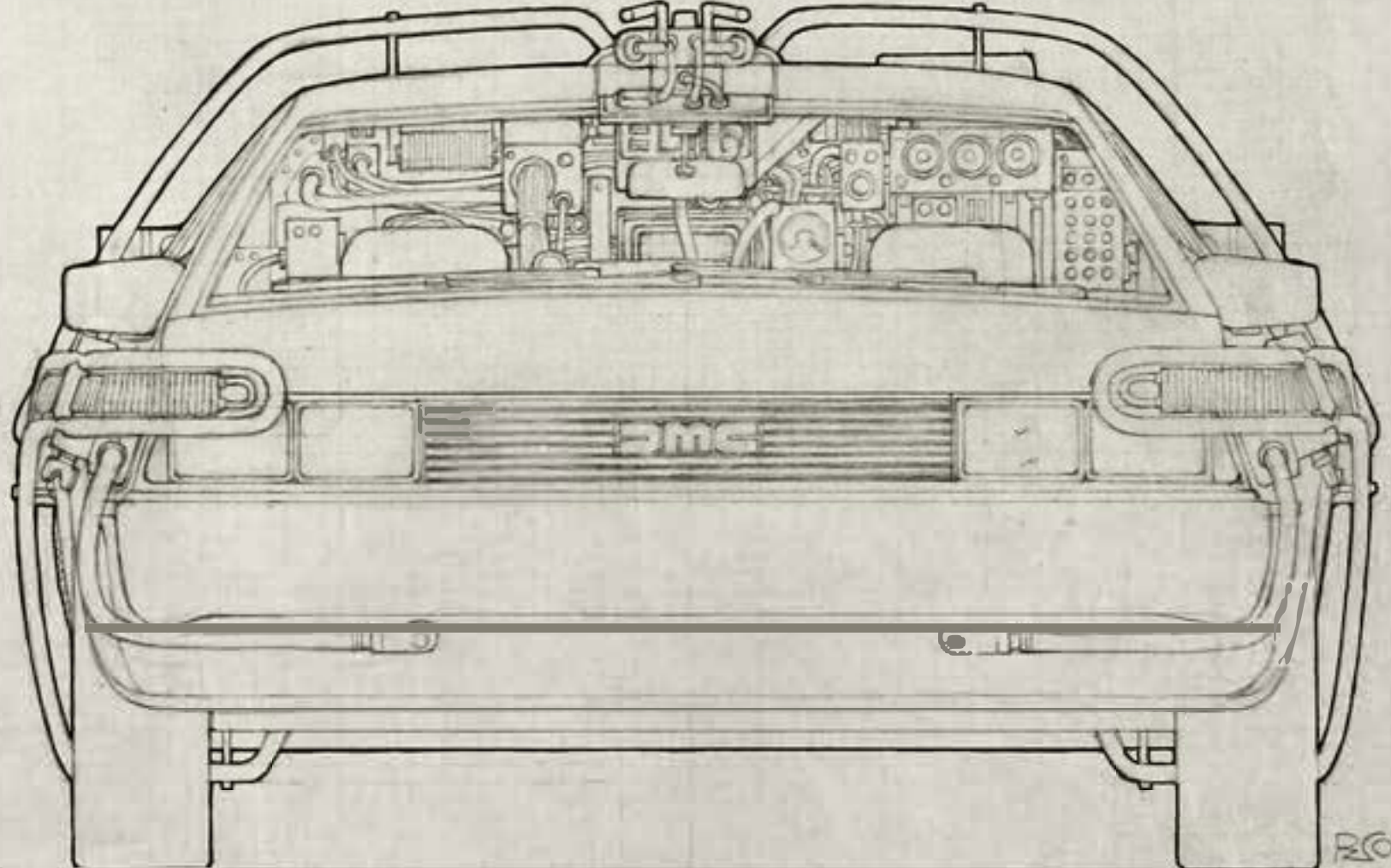
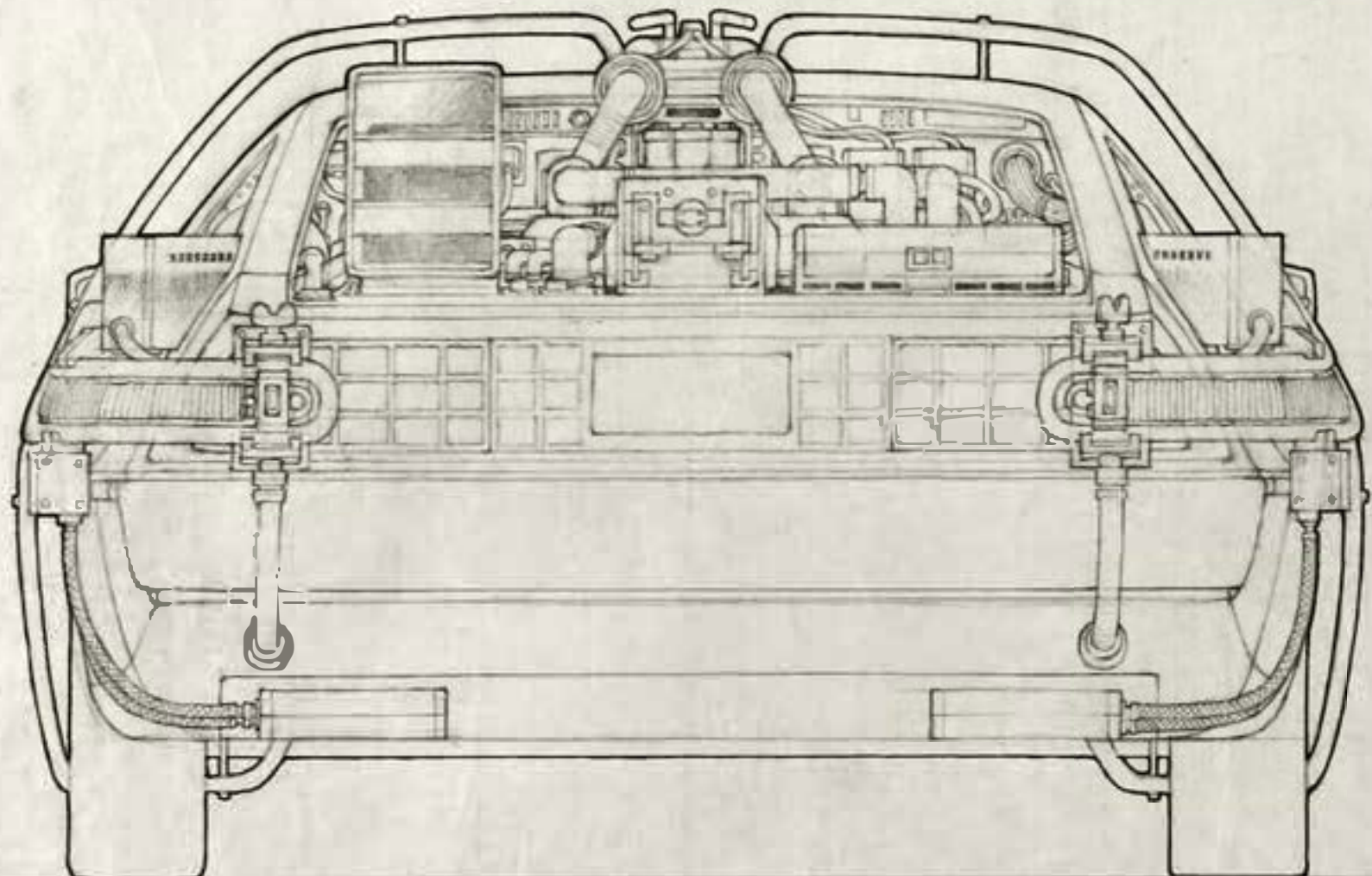

ROBB'84

